

5.355
PESO TEORICO: 0.435
PERIMETRO: 0.21

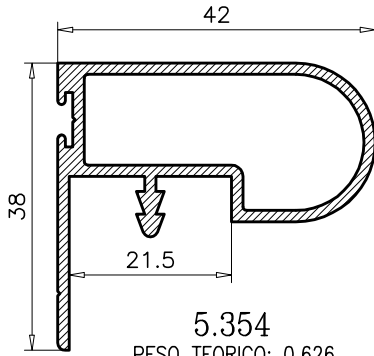

5.354
PESO TEORICO: 0.626
PERIMETRO: 0.29

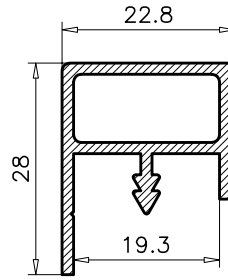

7.984
PESO TEORICO: 0.410
PERIMETRO: 0.19

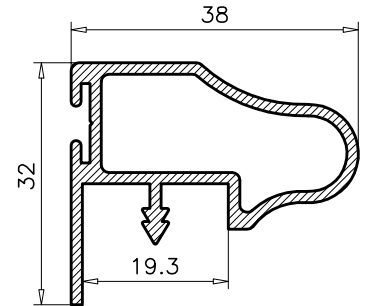

8.421
PESO TEORICO: 0.562
PERIMETRO: 0.26

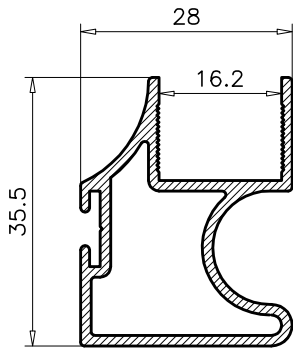

5.459
PESO TEORICO: 0.532
PERIMETRO: 0.28

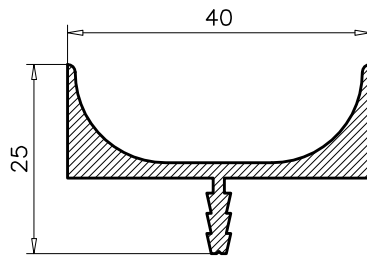

8.263
PESO TCO: 0.516
PTRO TOTAL: 0.15

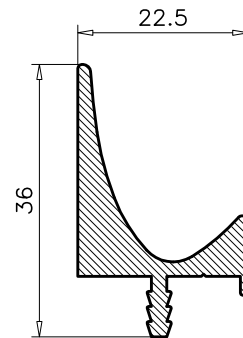

9.383
PESO TCO: 0.545
PTRO TOTAL: 0.13

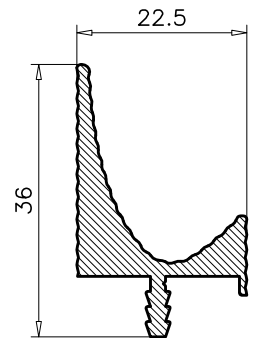

9.384
PESO TCO: 0.524
PTRO TOTAL: 0.13

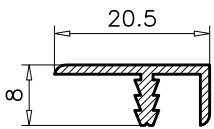

8.629
PESO TCO: 0.127
PTRO TOTAL: 0.08

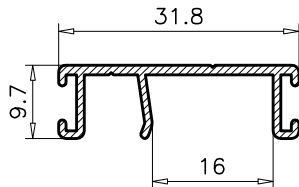

9.838
PESO TEORICO: 0.203
PERIMETRO: 0.13

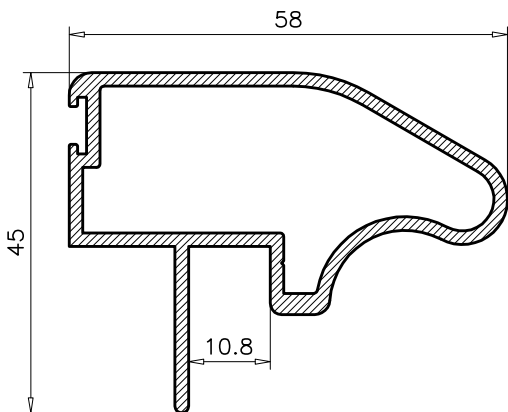

8.423
PESO TEORICO: 0.905
PERIMETRO: 0.36

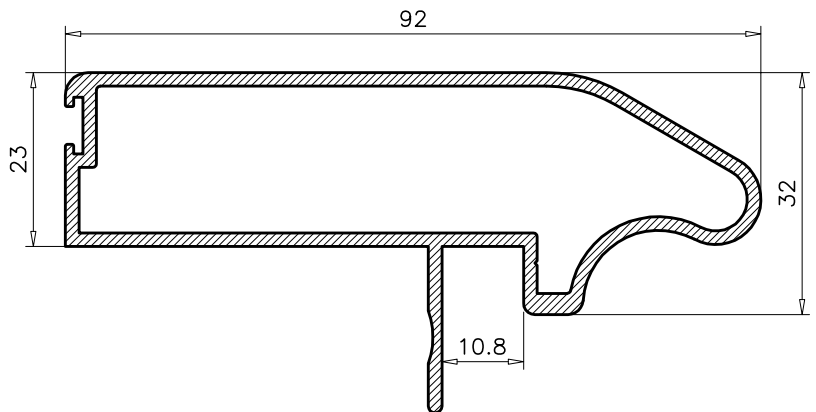

8.424
PESO TEORICO: 1.226
PERIMETRO: 0.50

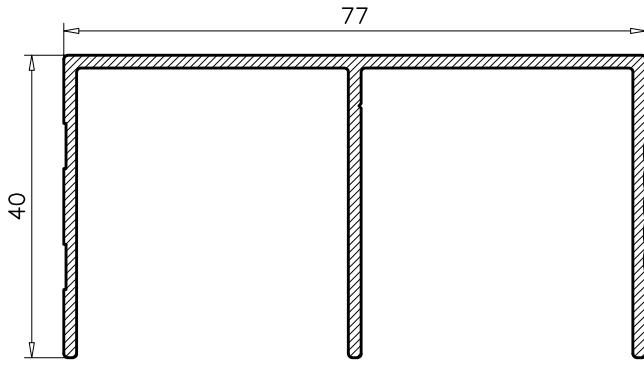

5.457
PESO TEORICO: 0.864
PERIMETRO: 0.39

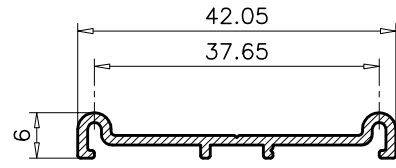

9.837
PESO TCO: 0.225
PERIMETRO: 0.12

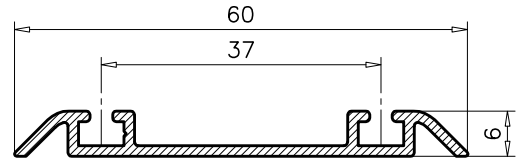

5.458
PESO TCO: 0.329
PERIMETRO: 0.17

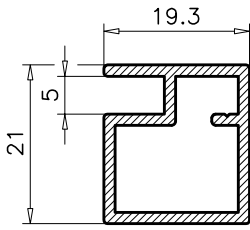

6.520
 PESO TCO: 0.348
 PERIMETRO: 0.17

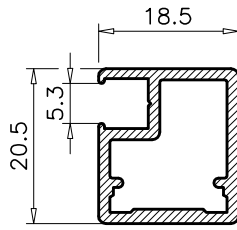

8.420
 PESO TCO: 0.340
 PERIMETRO: 0.16

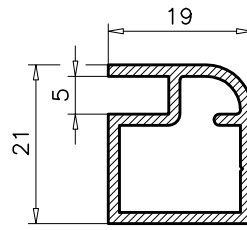

4.095
 PESO TCO: 0.335
 PERIMETRO: 0.17

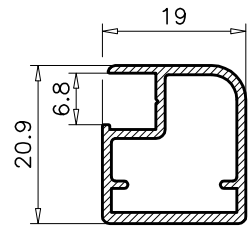

10.576
 PESO TCO: 0.278
 PERIMETRO: 0.17

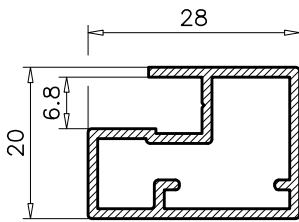

10.879
 PESO TCO: 0.375
 PERIMETRO: 0.21

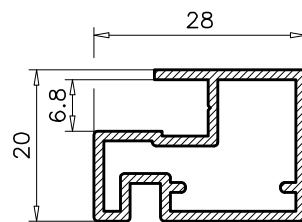

10.880
 PESO TCO: 0.397
 PERIMETRO: 0.22

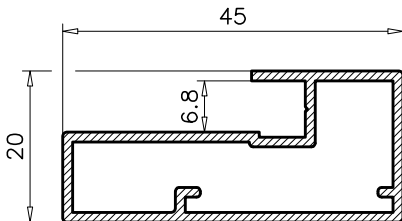

10.863
 PESO TCO: 0.491
 PERIMETRO: 0.28

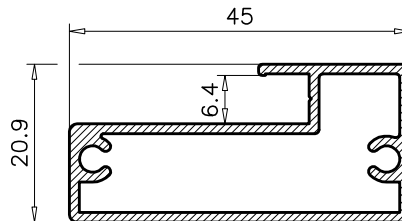

8.312
 PESO TCO: 0.535
 PERIMETRO: 0.30

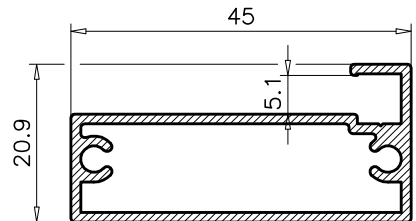

8.264
 PESO TCO: 0.518
 PERIMETRO: 0.28

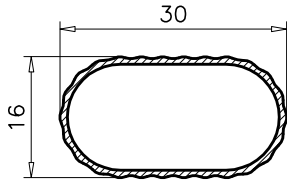

2.332
PESO TCO: 0.172
PERIMETRO: 0.15

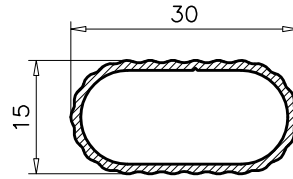

9.261
PESO TCO: 0.227
PERIMETRO: 0.15

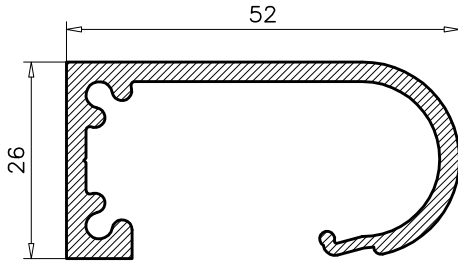

3.647
PESO TCO: 0.832
PERIMETRO: 0.24

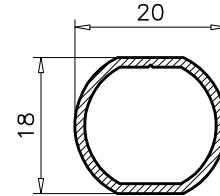

3.753
PESO TCO: 0.205
PERIMETRO: 0.12

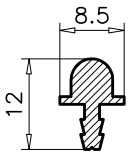

4.938
PESO TEORICO: 0.127
PERIMETRO: 0.10

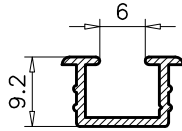

6.280
PESO TCO: 0.113
PERIMETRO: 0.10

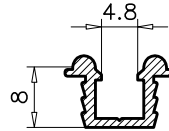

9.552
PESO TCO: 0.124
PERIMETRO: 0.10

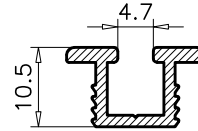

9.553
PESO TCO: 0.176
PERIMETRO: 0.10

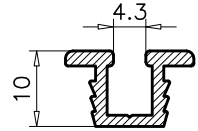

10.584
PESO TCO: 0.167
PERIMETRO: 0.10

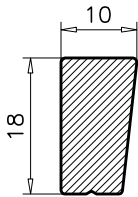

9.456
PESO TCO: 0.437
PERIMETRO: 0.10

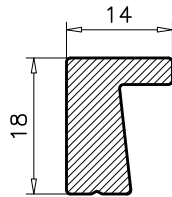

9.457
PESO TCO: 0.435
PERIMETRO: 0.10

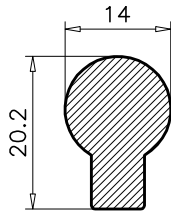

9.617
PESO TCO: 0.537
PERIMETRO: 0.10

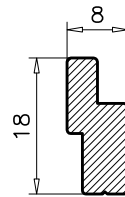

9.945
PESO TCO: 0.281
PERIMETRO: 0.10

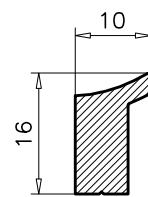

10.219
PESO TCO: 0.278
PERIMETRO: 0.10

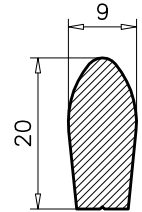

10.220
PESO TCO: 0.402
PERIMETRO: 0.10

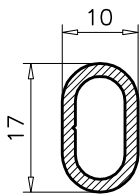

9.654
PESO TCO: 0.184
PERIMETRO: 0.10

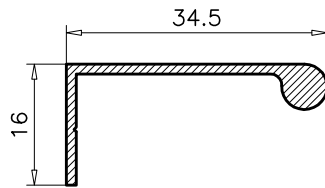

9.896
PESO TCO: 0.235
PERIMETRO: 0.11

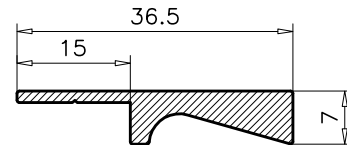

9.453
PESO TCO: 0.351
PERIMETRO: 0.10

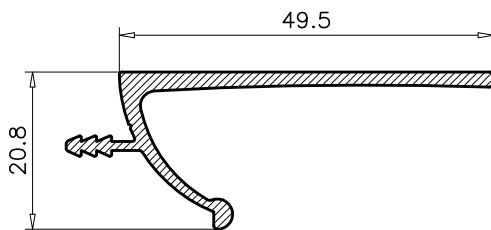

9.405
PESO TCO: 0.427
PERIMETRO: 0.17

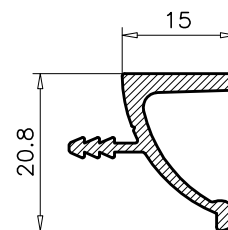

9.406
PESO TCO: 0.257
PERIMETRO: 0.10

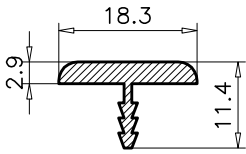

2.823
 PESO TEORICO: 0.173
 PERIMETRO: 0.10

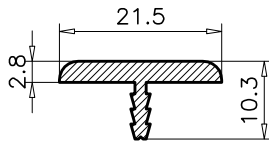

3.925
 PESO TEORICO: 0.194
 PERIMETRO: 0.10

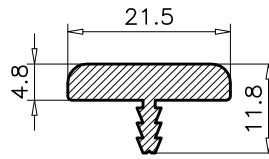

5.402
 PESO TEORICO: 0.313
 PERIMETRO: 0.10

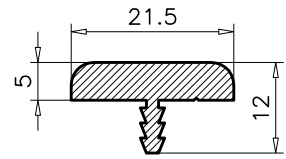

3.021
 PESO TEORICO: 0.324
 PERIMETRO: 0.10

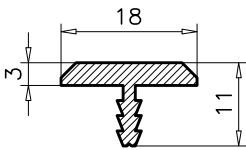

4.326
 PESO TEORICO: 0.184
 PERIMETRO: 0.10

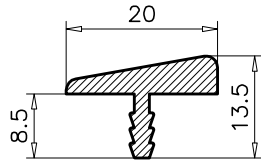

7.679
 PESO TEORICO: 0.243
 PERIMETRO: 0.10

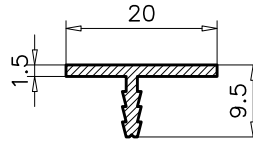

6.544
 PESO TEORICO: 0.121
 PERIMETRO: 0.10

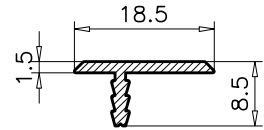

8.260
 PESO TEORICO: 0.105
 PERIMETRO: 0.10

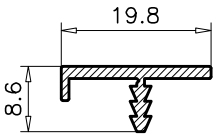

4.751
 PESO TEORICO: 0.127
 PERIMETRO: 0.10

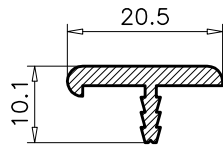

3.926
 PESO TEORICO: 0.184
 PERIMETRO: 0.10

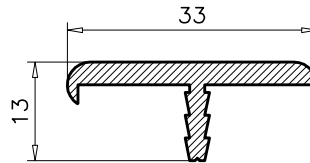

4.334
 PESO TEORICO: 0.332
 PERIMETRO: 0.10

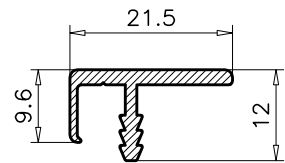

7.696
 PESO TEORICO: 0.189
 PERIMETRO: 0.10

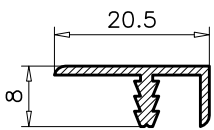

8.629
 PESO TCO: 0.127
 PTRO TOTAL: 0.08

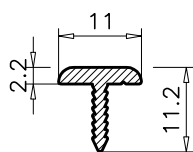

9.432
 PESO TEORICO: 0.115
 PERIMETRO: 0.10

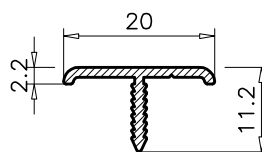

9.433
 PESO TEORICO: 0.126
 PERIMETRO: 0.10

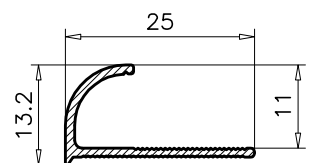

9.112
 PESO TEORICO: 0.140
 PERIMETRO: 0.10

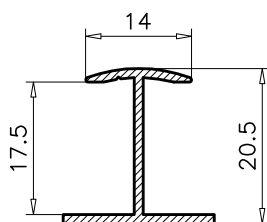

5.561
 PESO TEORICO: 0.165
 PERIMETRO: 0.11

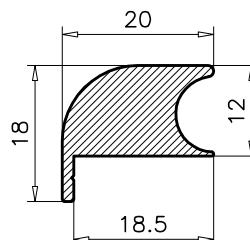

9.190
 PESO TEORICO: 0.559
 PERIMETRO: 0.10

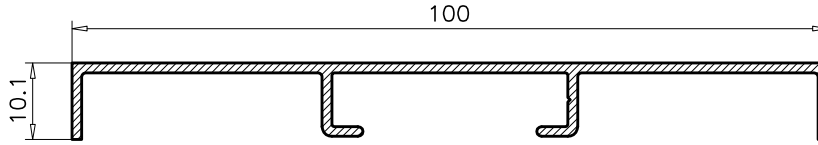

3.105
PESO TEORICO: 0.500
PERIMETRO: 0.29

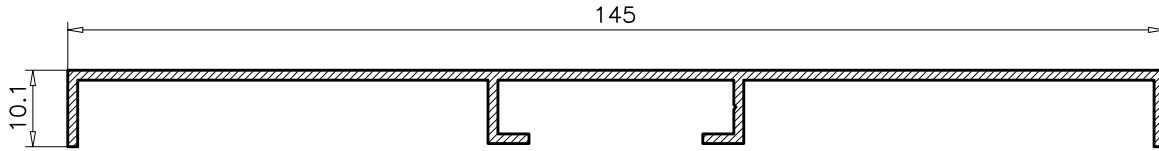

2.447
PESO TEORICO: 0.659
PERIMETRO: 0.38

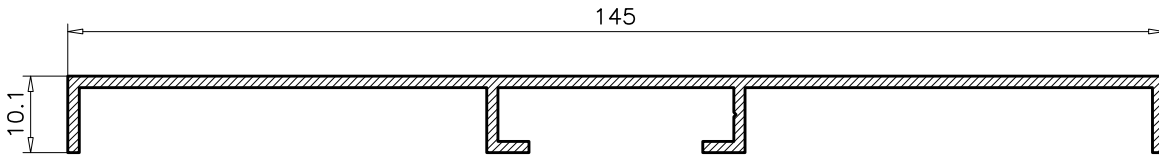

1.824
PESO TEORICO: 0.760
PERIMETRO: 0.38

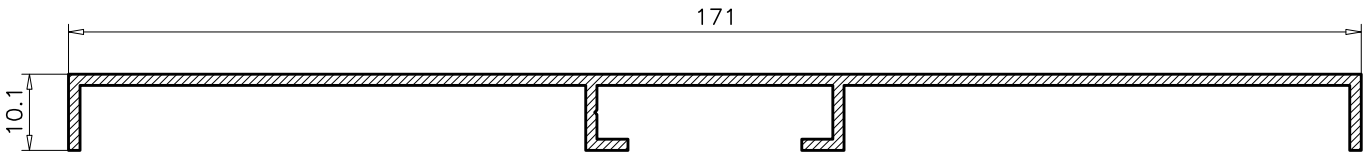

4.555
PESO TEORICO: 0.864
PERIMETRO: 0.43

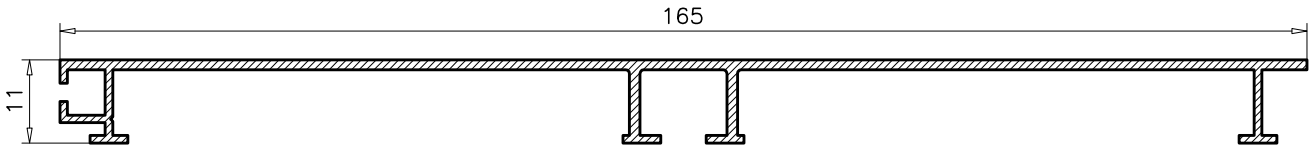

8122
PESO TCO: 0.772
PTRO TOTAL: 0.46

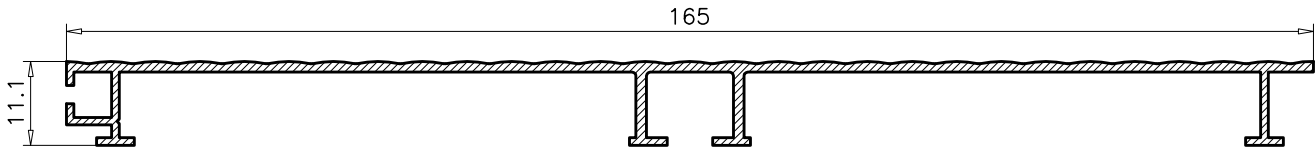

9.212
PESO TCO: 0.770
PTRO TOTAL: 0.461

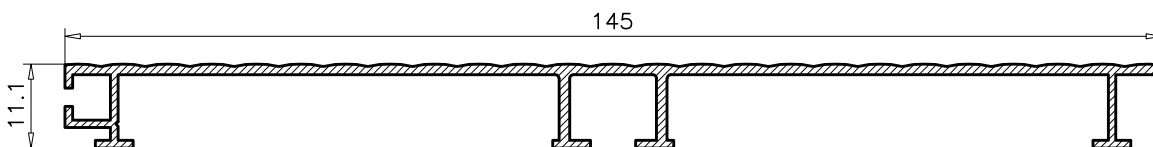

9.211
PESO TCO: 0.702
PTRO TOTAL: 0.420

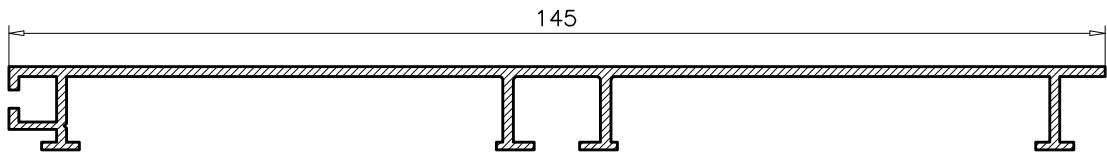

9.404

PESO TCO: 0.721
PTRO TOTAL: 0.42

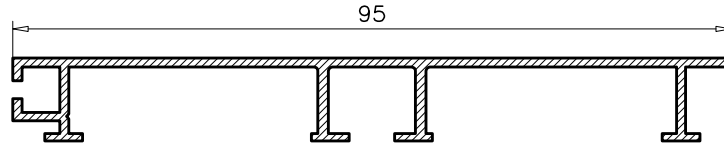

9.403

PESO TCO: 0.516
PTRO TOTAL: 0.32

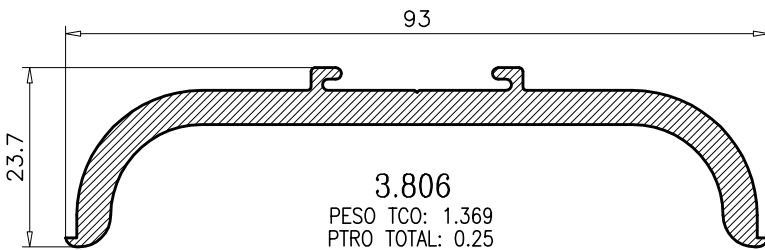

3.806

PESO TCO: 1.369
PTRO TOTAL: 0.25

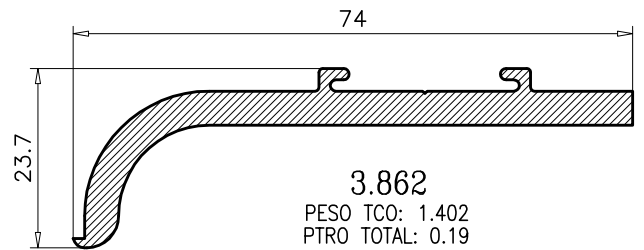

3.862

PESO TCO: 1.402
PTRO TOTAL: 0.19

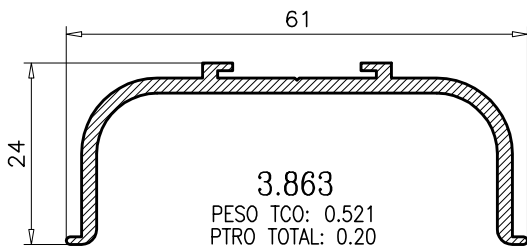

3.863

PESO TCO: 0.521
PTRO TOTAL: 0.20

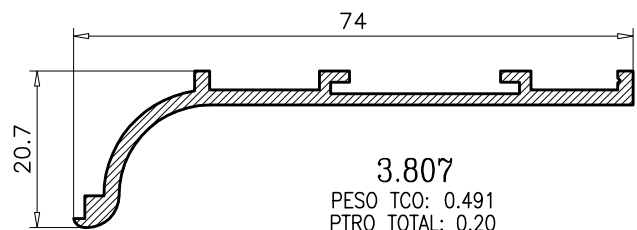

3.807

PESO TCO: 0.491
PTRO TOTAL: 0.20

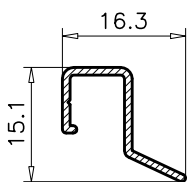

8.123

PESO TCO: 0.095
PTRO TOTAL: 0.07

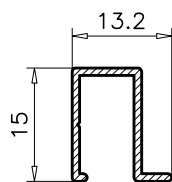

6.289

PESO TEORICO: 0.113
PERIMETRO: 0.10

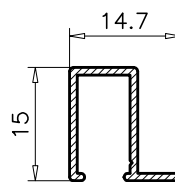

10.114

PESO TEORICO: 0.119
PERIMETRO: 0.10

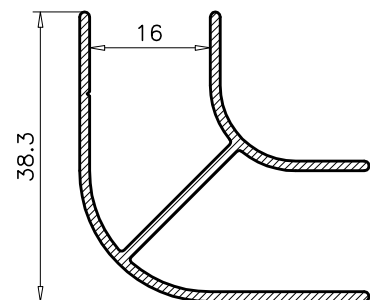

2.895

PESO TEORICO: 0.437
PERIMETRO: 0.25

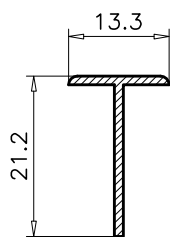

3.474

PESO TEORICO: 0.103
PERIMETRO: 0.10

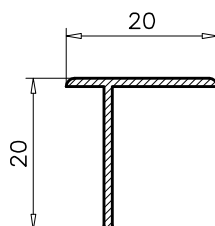

1.101

PESO TEORICO: 0.113
PERIMETRO: 0.10

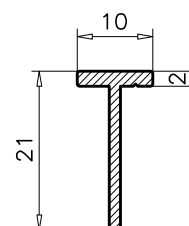

8.800

PESO TEORICO: 0.130
PERIMETRO: 0.10

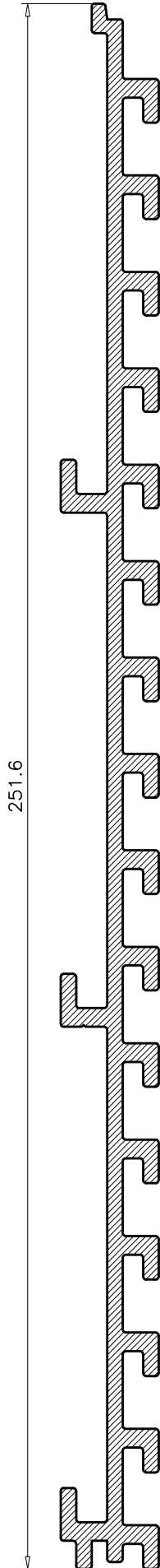

251.6

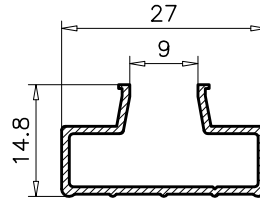

6.537

PESO TEORICO: 0.218
PERIMETRO: 0.14

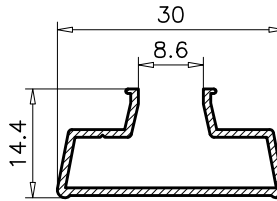

8.223

PESO TEORICO: 0.194
PERIMETRO: 0.15

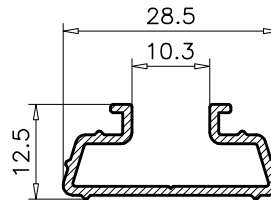

9.593

PESO TEORICO: 0.213
PERIMETRO: 0.13

8.390
PESO TEORICO: 3.213
PERIMETRO: 0.89

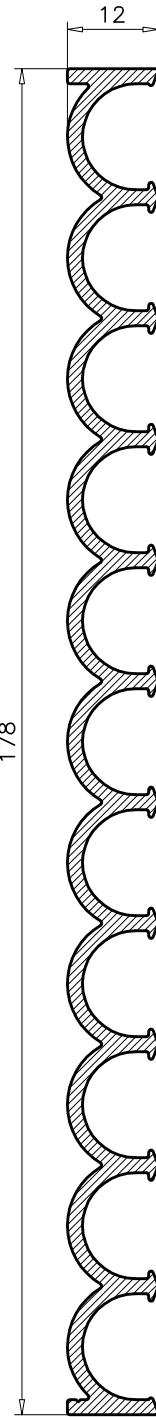

178

6.122

PESO TEORICO: 1.620
PERIMETRO: 0.59

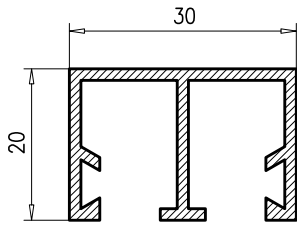

2.248
PESO TEORICO: 0.419
PERIMETRO: 0.21

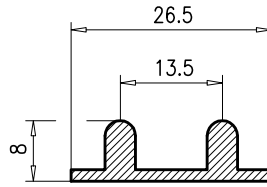

2.249
PESO TEORICO: 0.239
PERIMETRO: 0.1

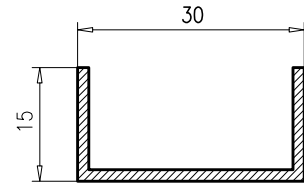

2.250
PESO TEORICO: 0.231
PERIMETRO: 0.12

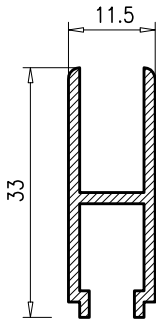

2.251
PESO TEORICO: 0.308
PERIMETRO: 0.16

ESQUEMA DE MONTAJE

