



serie 150_M

EXTRUAL sistemas ■■■

Sistema de motorización especialmente diseñada para nuestra Serie Minimalista E-150, para hojas de hasta 750Kgs de peso. Muy competitivo y desarrollado para optimizar el montaje reduciendo tiempos y mecanizados.

Todos los componentes de la motorización se alojan en el marco de tan solo 70mm de altura que se instala en la obra totalmente terminado y sin necesidad de dejar registros.

Estética minimalista de líneas rectas con marcos ocultos en obra y solo 25mm vistos en montantes verticales y 11mm en montantes horizontales. Marco inferior enrasado para una accesibilidad plena sin barreras. Sistema de drenaje oculto registrable integrado

Estanqueidad; Superior e Inferior con Felpudos Tri-Fin que garantizan el deslizamiento de las hojas. Cierres Laterales y Central con Juntas de EPDM que aseguran un comportamiento inmejorable en permeabilidad al aire y excelente en estanqueidad al agua.

Acristalamiento de 36mm con silicona estructural DOWSIL 775 InstanFix realizado por el carpintero en sus propias instalaciones, lo que le permite seleccionar al proveedor de vidrio.

Perfilería extruida en aluminio en aleación 6063, tratamiento térmico T5, según normas EN 515, EN 573-3 y EN 755-2, bajo certificación ISO 9001. Las tolerancias dimensionales y de espesor se ajustan a la norma UNE-EN 12020-2

Rotura de puente térmico mediante perfiles de poliamida 6.6 reforzada con un 25% de fibra de vidrio. Unión garantizada entre aluminio y poliamida con una resistencia mínima a la Tracción de 80 N/mm y al Cizallamiento de 30 n/mm.

Protección superficial; Lacado con garantía QUALICOAT-SEASIDE con espesor mínimo de 60 micras, o Anodizado con espesor mínimo 15 micras con garantía QUALANOD (EWAA-EURAS).

Los herrajes han sido diseñados o seleccionados por EXTRUAL, a través de los distintos ensayos realizados aseguran la calidad del producto final.

Las dimensiones de corte indicadas en este catálogo son teóricas, y pueden verse afectadas mínimamente por las tolerancias de extrusión de los perfiles o por los tratamientos de lacado y anodizado, así mismo deben de adaptarse a la precisión de las máquinas de corte de cada taller, por lo que es aconsejable fabricar una muestra para su control dimensional.

Es fundamental realizar las salidas de evacuación de agua en marcos y sellar correctamente los cortes e ingletes para evitar infiltraciones.

Sólo se garantiza el correcto funcionamiento del sistema si se han utilizado los perfiles y accesorios propios del mismo recogidos en este catálogo o en su caso recomendados por EXTRUAL.

Las dimensiones máximas de los cerramientos, su fabricación, acristalamiento y puesta en obra de los productos contruidos con los Sistemas EXTRUAL deben cumplir la Normativa UNE e instrucciones Técnicas vigentes.

Todos los perfiles y accesorios que aparecen en este catálogo son propios de EXTRUAL, no pudiendo ser copiados o modificados sin autorización.

EXTRUAL se reserva el derecho a modificar, sin previo aviso, cualquiera de los productos que aparecen en este catálogo. Queda prohibida la reproducción total o parcial de este catálogo sin la autorización expresa por parte de EXTRUAL.

COEFICIENTES DE TRANSMITANCIA TERMICA U_H (W/m²K) Según CTE y UNE-EN 10077-1

$U_{H,v}$	PUERTA 2 HOJAS											
	4,00m ²	5,00m ²	6,00m ²	7,00m ²	8,00m ²	9,00m ²	10,00m ²	11,00m ²	12,00m ²	13,00m ²	14,00m ²	15,00m ²
0,5	1,3	1,3	1,5	1,1	1,1	1,1	1,0	1,0	1,0	1,0	1,0	0,9
0,6	1,4	1,3	1,5	1,2	1,2	1,2	1,1	1,1	1,1	1,1	1,1	1,0
0,7	1,5	1,4	1,6	1,3	1,3	1,2	1,2	1,2	1,2	1,2	1,1	1,1
0,8	1,6	1,5	1,7	1,4	1,4	1,3	1,3	1,3	1,3	1,2	1,2	1,2
0,9	1,7	1,6	1,8	1,5	1,5	1,4	1,4	1,4	1,4	1,3	1,3	1,3
1,0	1,8	1,7	1,9	1,6	1,5	1,5	1,5	1,5	1,4	1,4	1,4	1,4
1,1	1,8	1,8	1,9	1,7	1,6	1,6	1,6	1,6	1,5	1,5	1,5	1,5
1,2	1,9	1,8	2,0	1,8	1,7	1,7	1,7	1,6	1,6	1,6	1,6	1,6
1,3	2,0	1,9	2,1	1,8	1,8	1,8	1,8	1,7	1,7	1,7	1,7	1,7
1,4	2,1	2,0	2,2	1,9	1,9	1,9	1,8	1,8	1,8	1,8	1,8	1,8
1,5	2,2	2,1	2,3	2,0	2,0	2,0	1,9	1,9	1,9	1,9	1,9	1,9
1,6	2,2	2,2	2,3	2,1	2,1	2,0	2,0	2,0	2,0	2,0	2,0	1,9
1,7	2,3	2,3	2,4	2,2	2,2	2,1	2,1	2,1	2,1	2,1	2,0	2,0
1,8	2,4	2,4	2,5	2,3	2,2	2,2	2,2	2,2	2,2	2,2	2,1	2,1
1,9	2,5	2,4	2,6	2,4	2,3	2,3	2,3	2,3	2,3	2,2	2,2	2,2
2,0	2,6	2,5	2,7	2,4	2,4	2,4	2,4	2,4	2,3	2,3	2,3	2,3
2,1	2,7	2,6	2,7	2,5	2,5	2,5	2,5	2,4	2,4	2,4	2,4	2,4
2,2	2,8	2,7	2,8	2,6	2,6	2,6	2,6	2,5	2,5	2,5	2,5	2,5
2,3	2,8	2,8	2,9	2,7	2,7	2,7	2,6	2,6	2,6	2,6	2,6	2,6
2,4	2,9	2,9	3,0	2,8	2,8	2,8	2,7	2,7	2,7	2,7	2,7	2,7
2,5	3,0	2,9	3,1	2,9	2,9	2,8	2,8	2,8	2,8	2,8	2,8	2,8
2,6	3,1	3,0	3,1	3,0	2,9	2,9	2,9	2,9	2,9	2,9	2,9	2,9
2,7	3,2	3,1	3,2	3,1	3,0	3,0	3,0	3,0	3,0	3,0	3,0	2,9
2,8	3,3	3,2	3,3	3,1	3,1	3,1	3,1	3,1	3,1	3,1	3,0	3,0
2,9	3,3	3,3	3,4	3,2	3,2	3,2	3,2	3,2	3,1	3,1	3,1	3,1

U_H Coeficiente de Transmisión Térmica de la puerta completa (W/m²K)

$U_{H,v}$ Coeficiente de Transmisión Térmica del vidrio (W/m²K)

El Coeficiente de Transmisión Térmica es el flujo de calor (W) dividido por la superficie (m²) y por la diferencia de temperatura (K) a cada lado de la puerta.

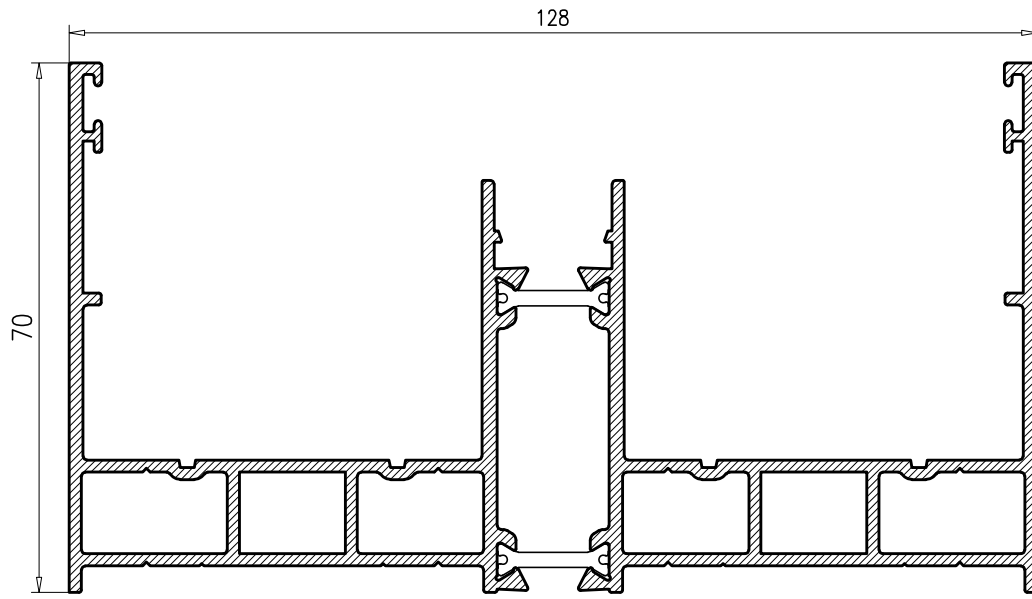

R-954

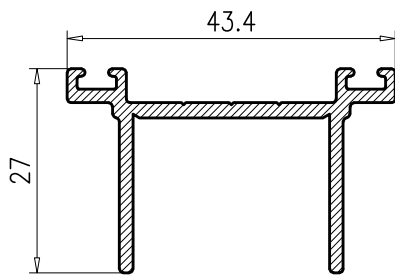

16.857

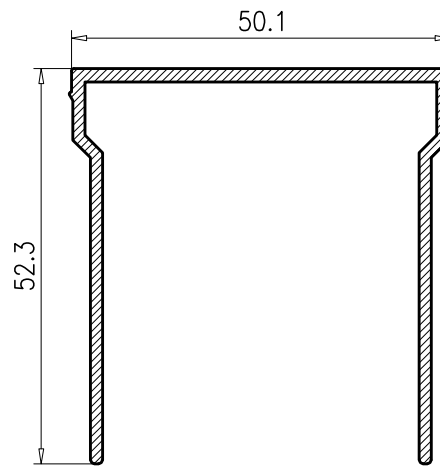

16.858

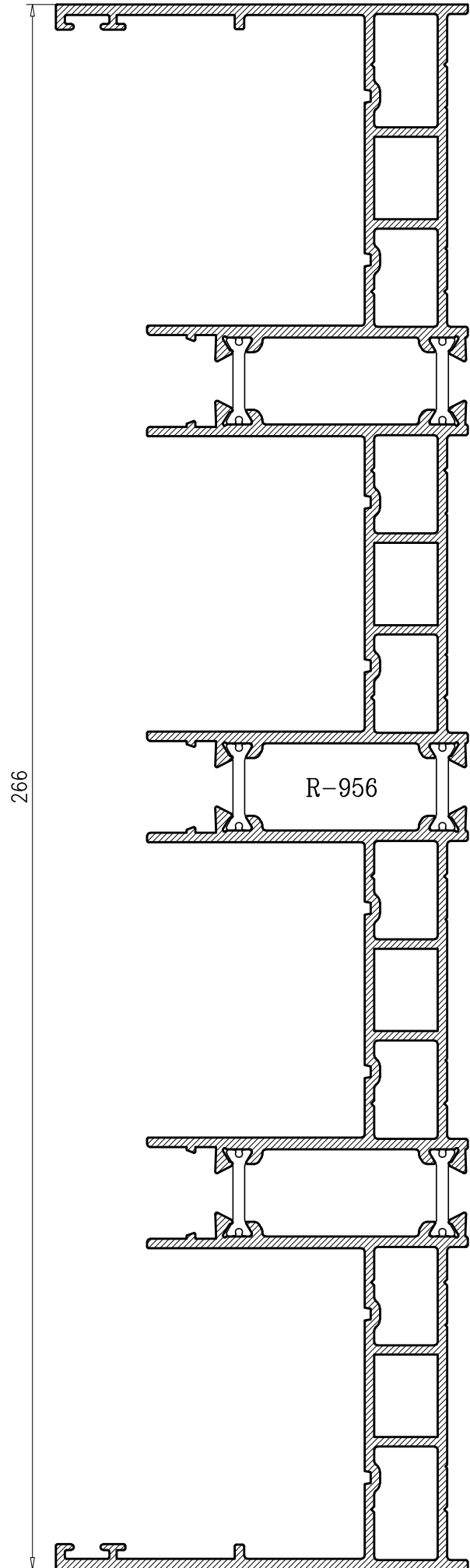
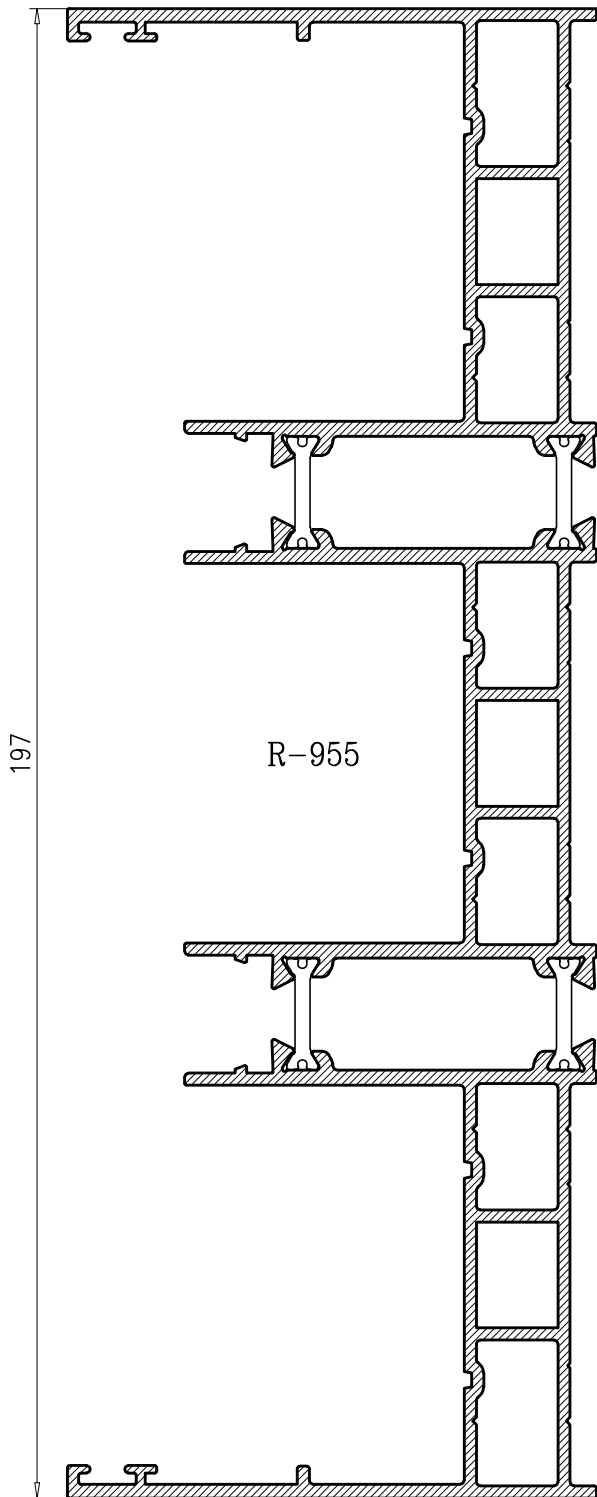

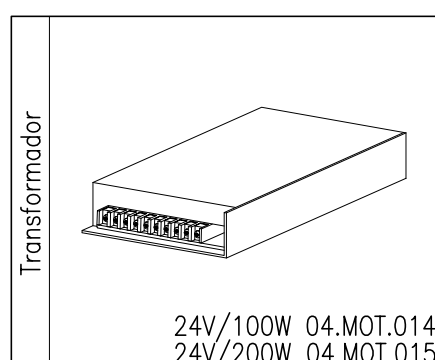
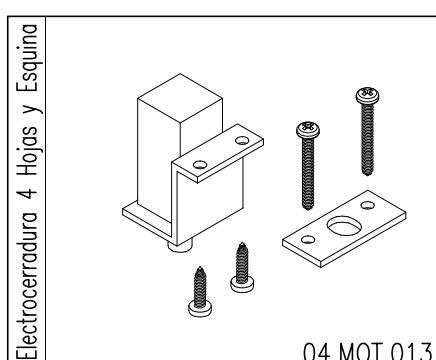
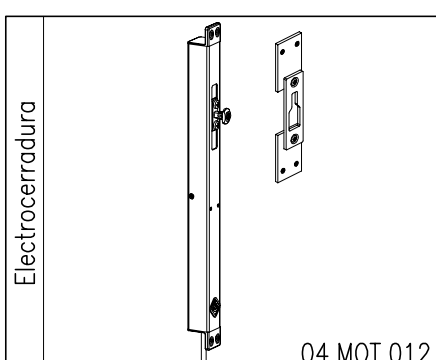
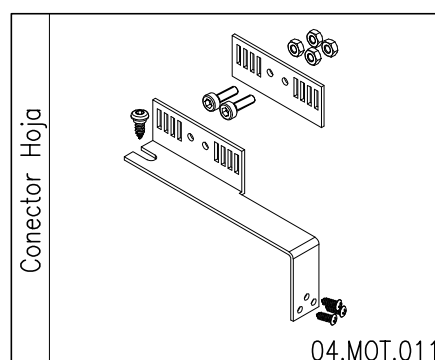
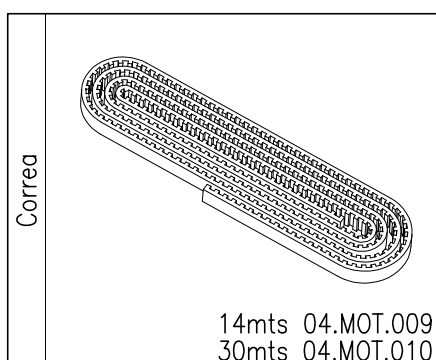
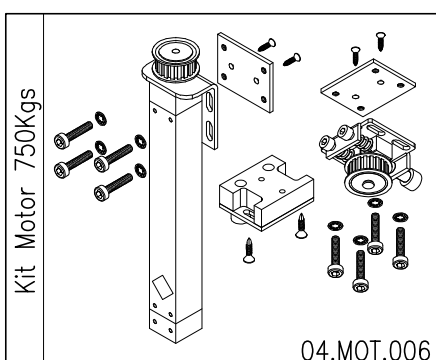
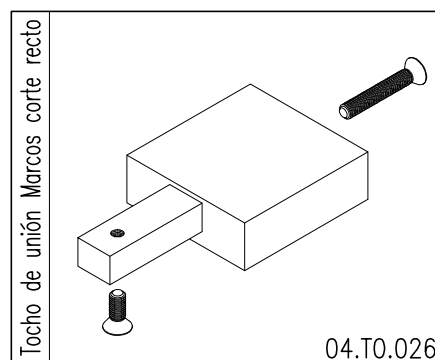
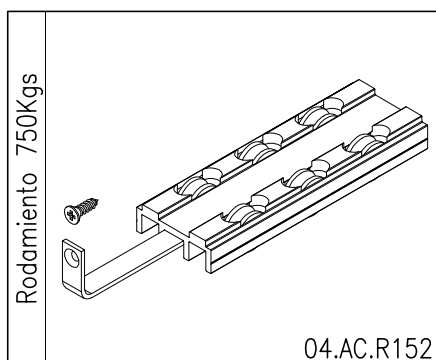
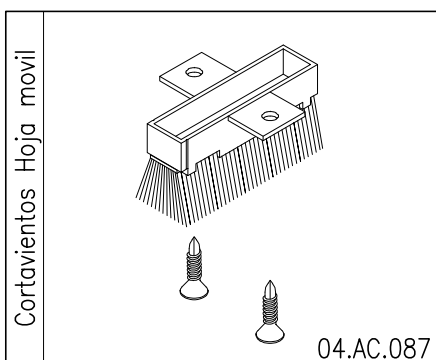
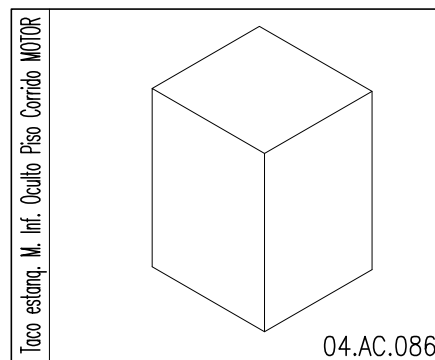
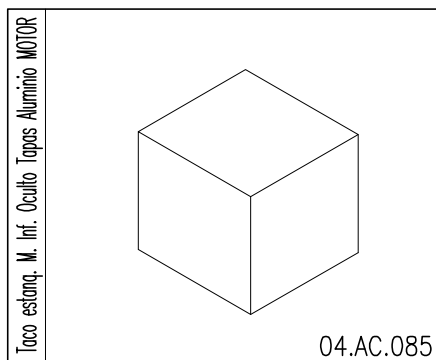
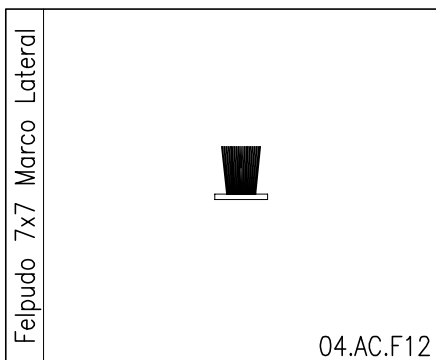
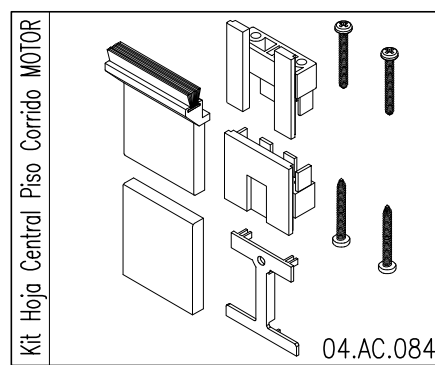
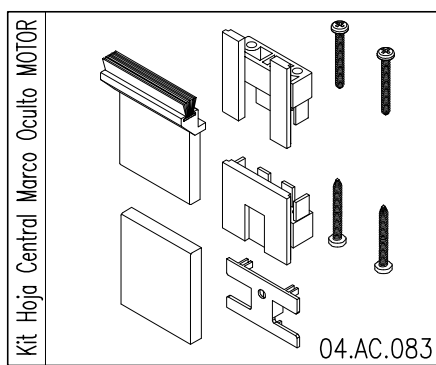
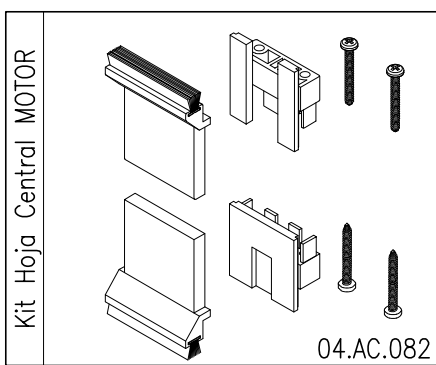

Botonera

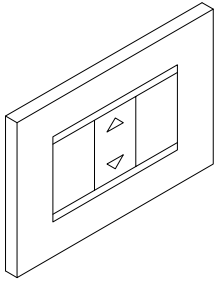

04.MOT.016

Gateway

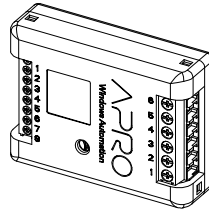

04.MOT.017

Llave desbloqueo electrocerradura

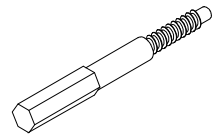

04.MOT.018

Plantilla

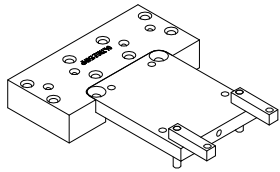

04.TRO.E150MP

Troquel

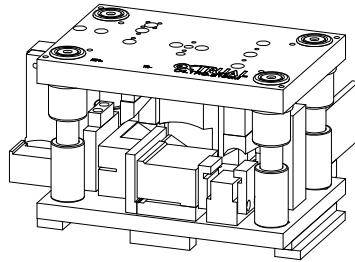

04.TRO.E150M

SECCION VERTICAL 1 HOJA + FIJO

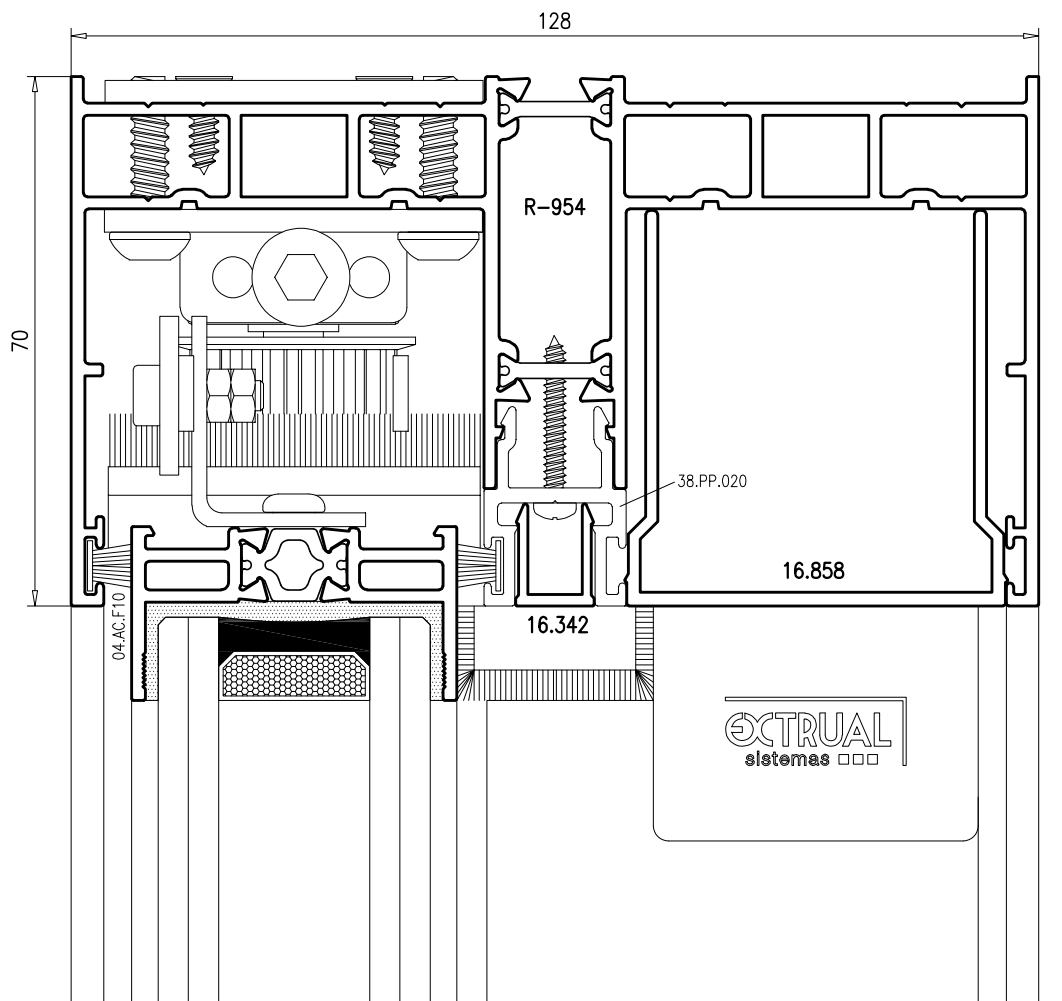
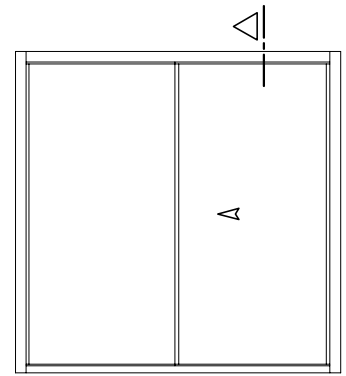

SECCION VERTICAL 2 HOJAS

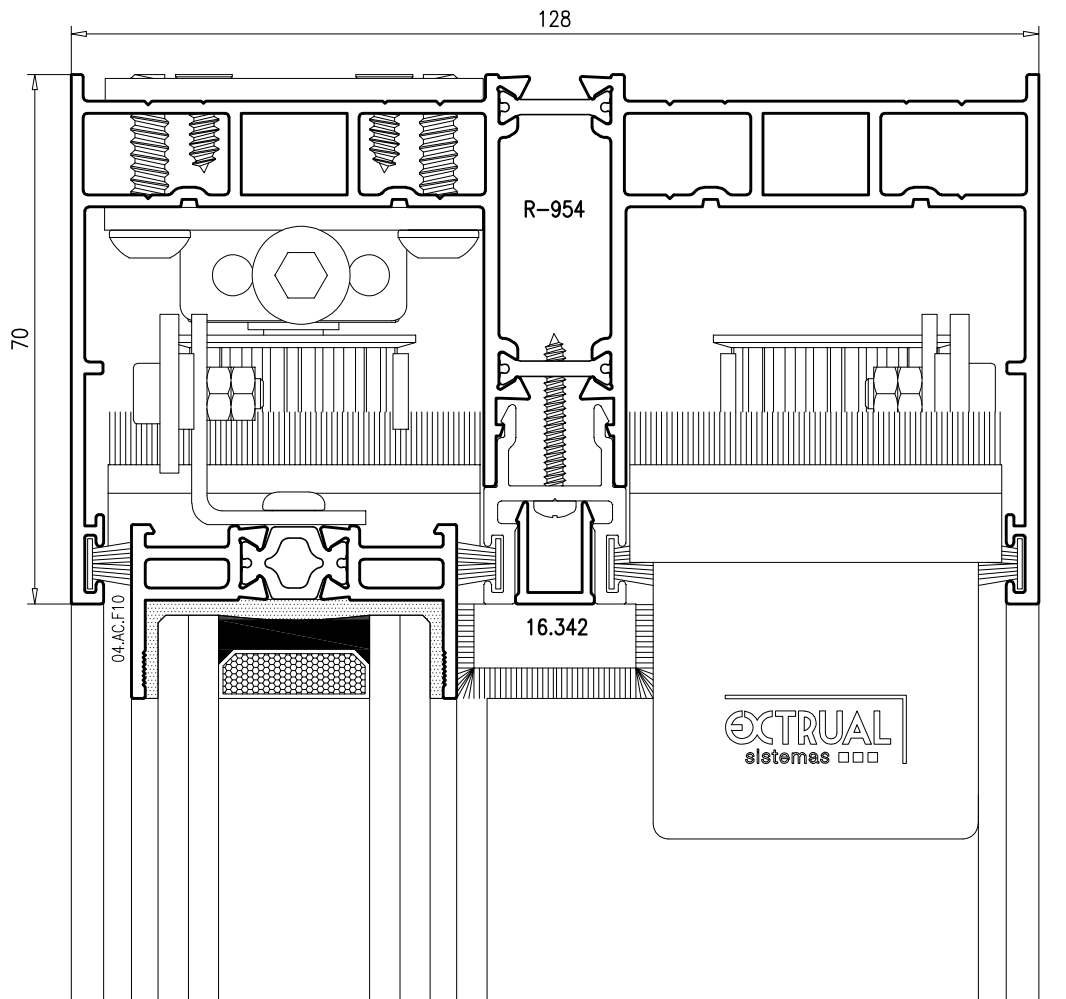
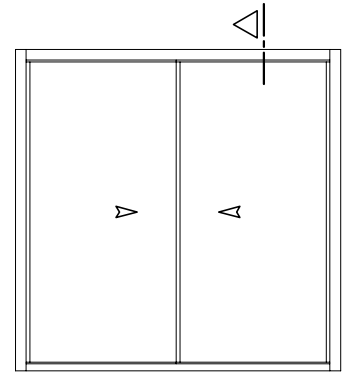

SECCION HORIZONTAL LATERAL 1 HOJA MOTORIZADA + 1 HOJA MANUAL

PARA CUALQUIER COMPOSICION DE HOJAS MANUALES CON MOTORIZADAS CAMBIAN LAS HOJAS DE CORTE Y DESPIECE. SOLICITAR A EXTRUAL

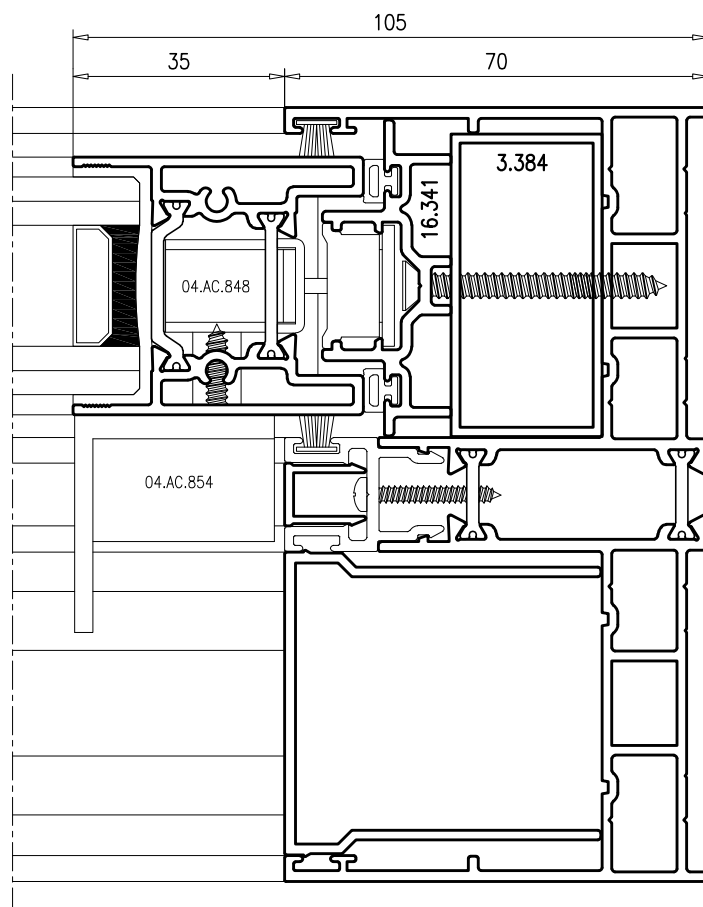
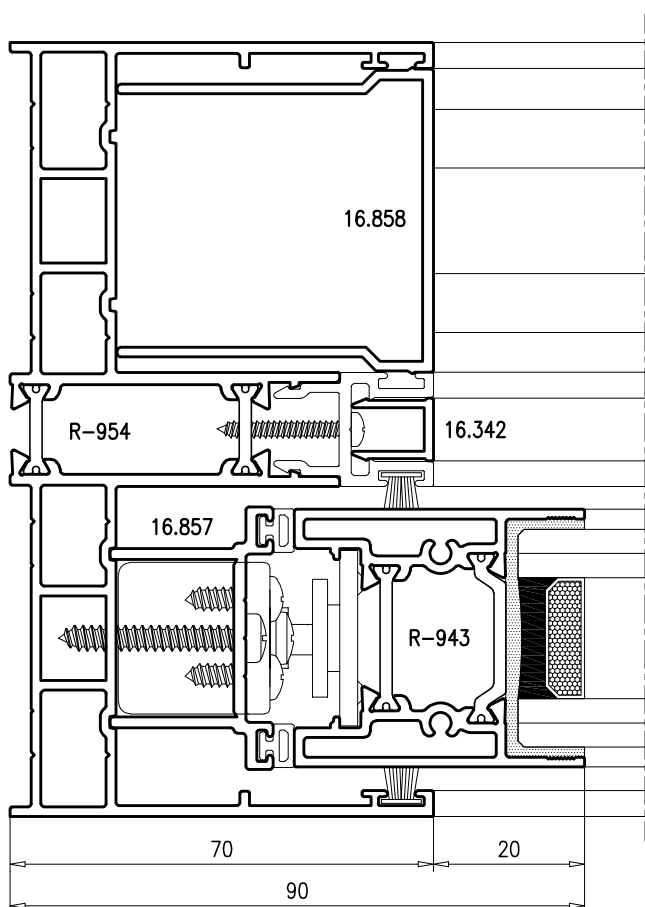
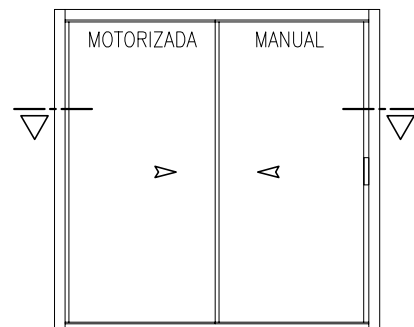

MARCO 2 CARRILES

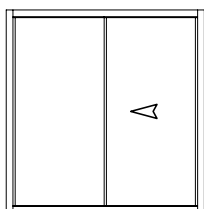

1 HOJA + FIJO

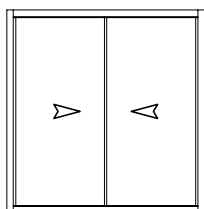

2 HOJAS

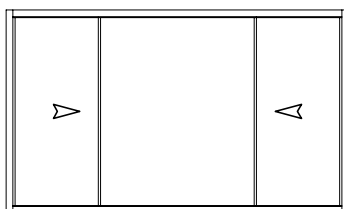

2 HOJAS + FIJO CENTRAL

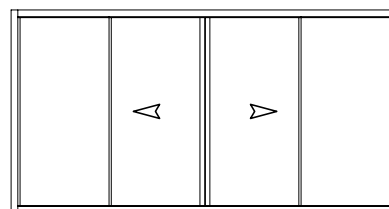

2 HOJAS + 2 FIJOS LATERALES

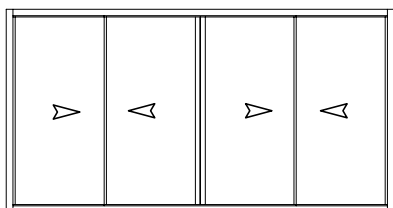

4 HOJAS

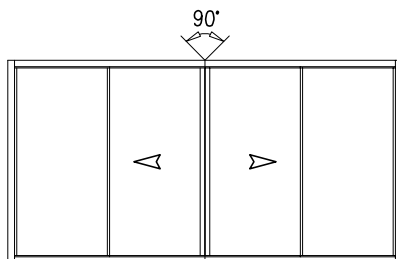

ESQUINA 2 HOJAS + 2 FIJOS

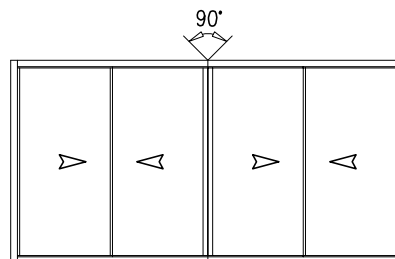

ESQUINA 2+2 HOJAS

MARCO 2 CARRILES Hojas ocultas en muro

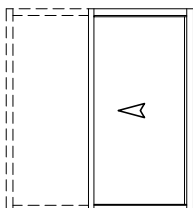

1HOJA

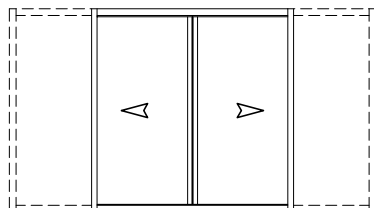

2 HOJAS

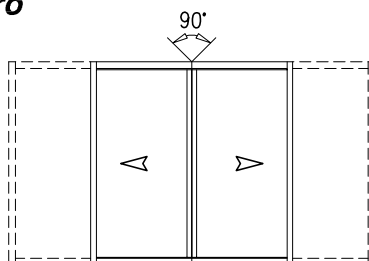

ESQUINA 2 HOJAS

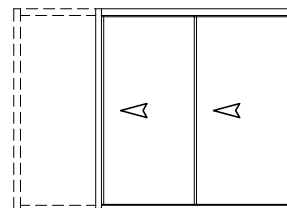

2 HOJAS

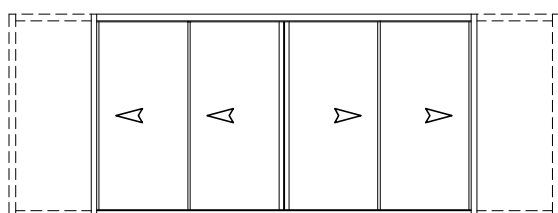

4 HOJAS
Aperturas independientes (2 pulsadores)

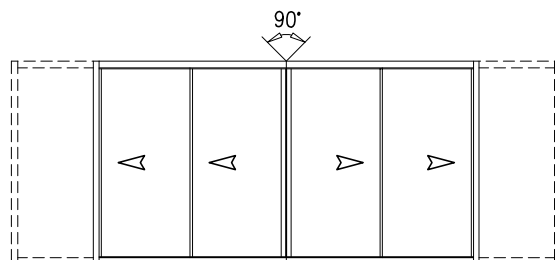

ESQUINA 2+2 HOJAS
Aperturas independientes condicionadas (2 pulsadores)

MARCO 3 CARRILES

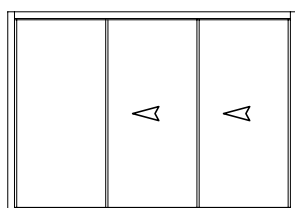

2 HOJAS + FIJO LATERAL

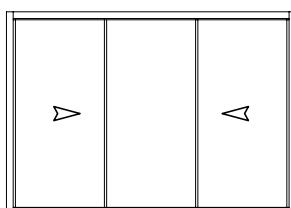

2 HOJAS + FIJO CENTRAL

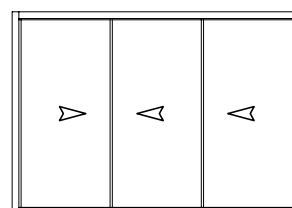

3 HOJAS

MARCO 3 CARRILES

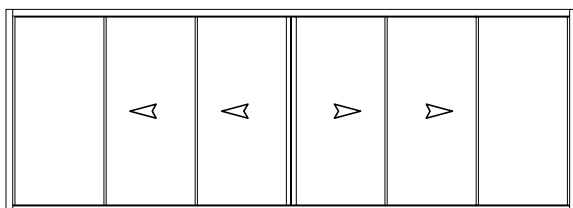

4 HOJAS + FIJOS LATERALES
Aperturas independientes (2 pulsadores)

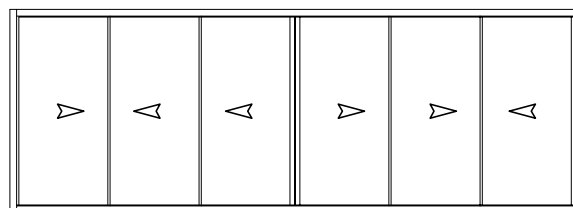

6 HOJAS
Aperturas independientes (4 pulsadores)

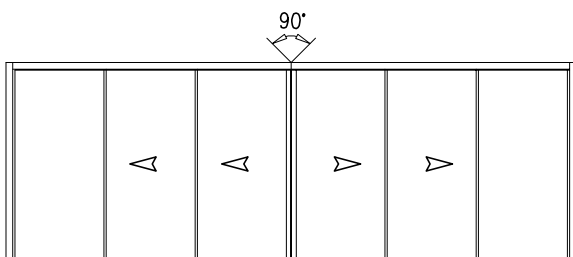

ESQUINA 2 HOJAS+FIJO 2 HOJAS+FIJO
Aperturas independientes condicionadas (2 pulsadores)

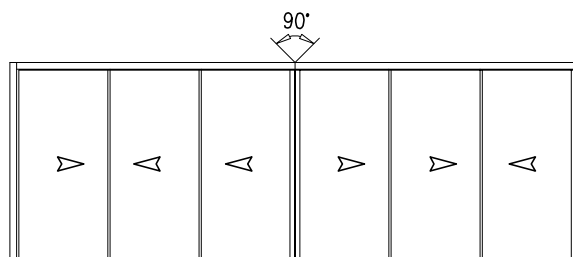

ESQUINA 3+3 HOJAS
Aperturas independientes condicionadas (4 pulsadores)

MARCO 3 CARRILES Hojas ocultas en muro

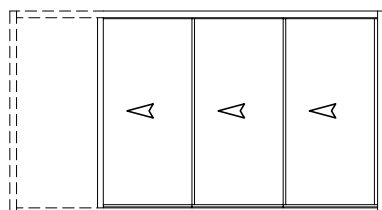

3 HOJAS

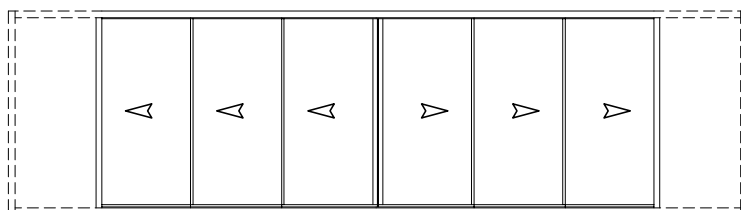

3+3 HOJAS
Aperturas independientes (2 pulsadores)

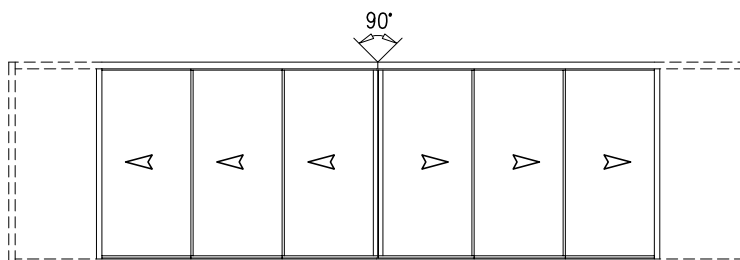

ESQUINA 3+3 HOJAS
Aperturas independientes condicionadas (2 pulsadores)

MARCO 4 CARRILES

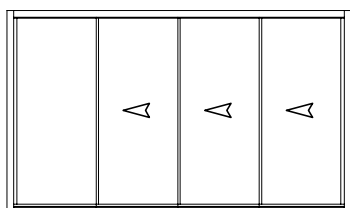

3 HOJAS + FIJO LATERAL

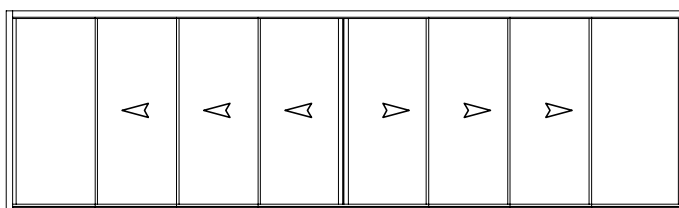

6 HOJAS + FIJOS LATERALES
Aperturas independientes (2 pulsadores)

BALCONERA 1 HOJA + FIJO

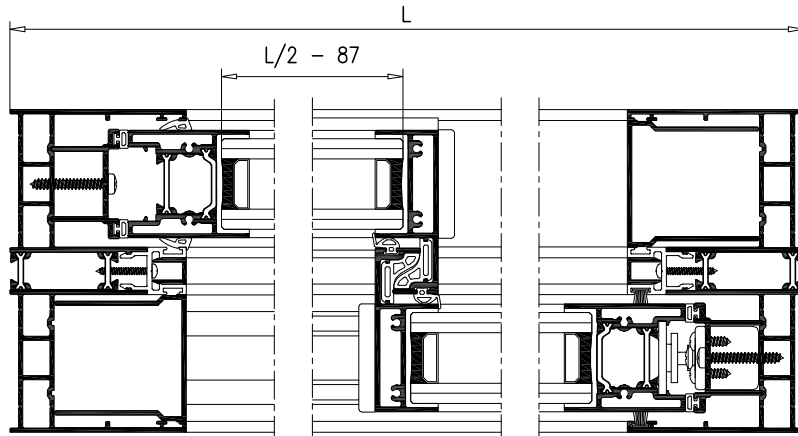
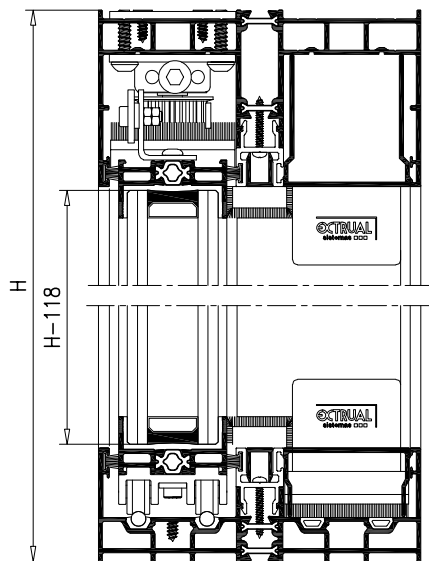

BALCONERA 1 HOJA + FIJO
Marco Inferior Oculto Tapas de Aluminio

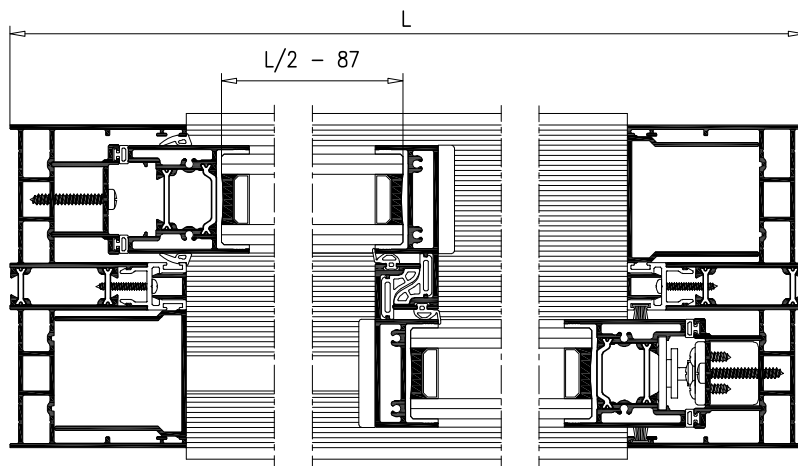
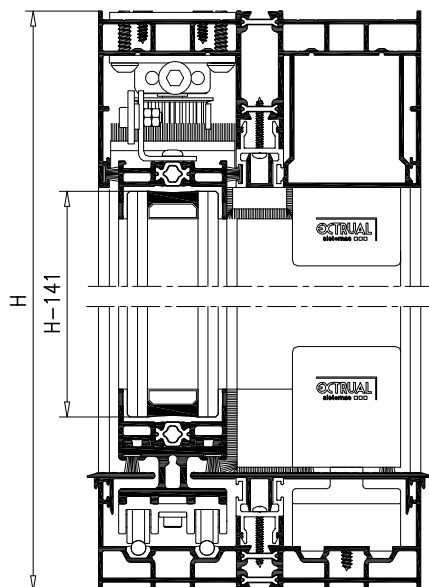



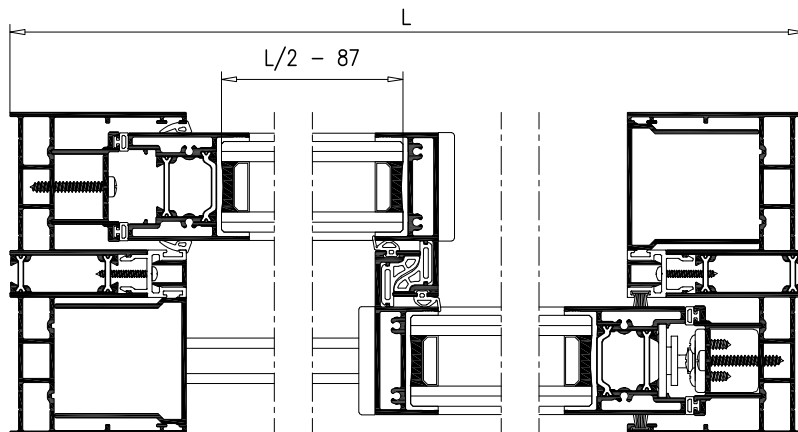
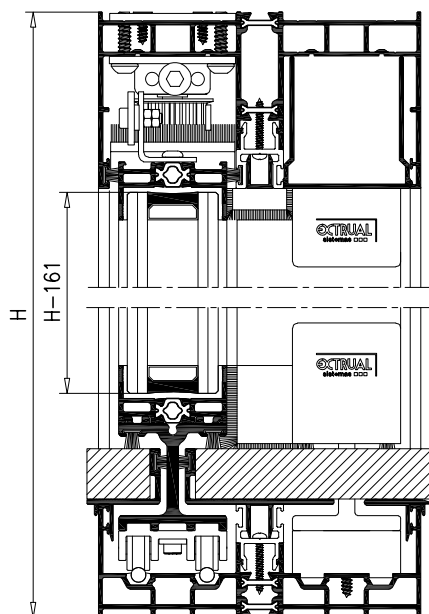





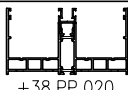
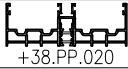









BALCONERA 1 HOJA + FIJO
Marco Inferior Oculto Piso Corrido



BALCONERA 1 HOJA + FIJO

PERFILES

REFERENCIA	DENOMINACION	MARCO INFERIOR VISTO		MARCO INFERIOR OCULTO TAPAS ALUMINIO		MARCO INFERIOR OCULTO PISO CORRIDO		
		CANT.	CORTE	CANT.	CORTE	CANT.	CORTE	
R-954	 +38.PP.020	MARCO LAT/SUP	2	H	2	H	2	H
			1	L-140	1	L-140	1	L-140
R-941	 +38.PP.020	MARCO INFERIOR	1	L-140	1	L-140	1	L-140
R-943		HOJA LATERAL	2	H-140	2	H-163	2	H-183
R-945		HOJA SUP/INF	4	(L/2)-47	4	(L/2)-47	4	(L/2)-47
16.349		SUPLEMENT. HOJA			2	(L/2)-47		
16.651		SUPLEMENT. HOJA					4	(L/4)-23.5
16.347		HOJA DE CIERRE	2	H-140	2	H-163	2	H-183
16.857		CIERRE LATERAL	2	H-75	2	H-114	2	H-134
16.342		TAPA CANAL	2	H-96	2	H-96	2	H-96
			4	(L/2)-83	2	(L/2)-83	2	(L/2)-83
16.858		TAPA MARCO LAT/SUP	2	H-36	2	H-36	2	H-36
			1	(L/2)-83	1	(L/2)-83	1	(L/2)-83
16.343		TAPA MARCO INFERIOR	1	(L/2)-83				
16.344*		TAPA CENTRAL			1	(L/2)-54		
16.345*		TAPA LATERAL			1	(L/2)-54		
					1	L-140	1	L-140
16.346*		TAPA DOBLE			1	(L/2)-87		
16.652*		TAPA CENTRAL			1	(L/2)-54		
16.653*		TAPA LATERAL			1	(L/2)-54		
					1	L-140		
16.654*		TAPA MULTIPLE			1	(L/2)-87		
R-948		SOLERA	1	L-4	1	L-4	1	L-4
15.686		TAPA CANALETA	1	L-144	1	L-144		
16.351		CANALETA DRENAJE	1	L-194	1	L-144	1	L-144

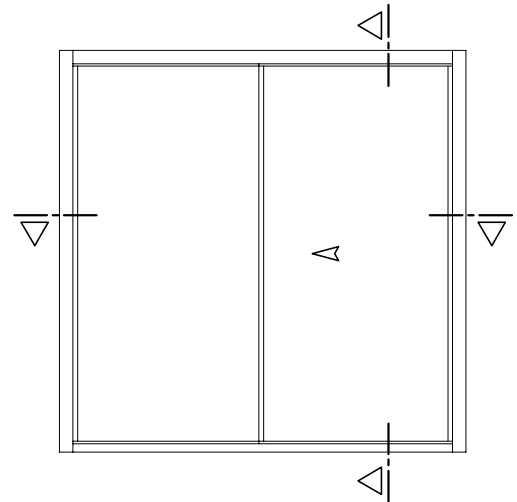

ACCESORIOS

REFERENCIA	DENOMINACION	M.INF. VISTO	M.INF. OCULTO TAPAS ALUMINIO	M.INF. OCULTO PISO CORRIDO
		UNIDADES	UNIDADES	UNIDADES
04.MOT.006	Kit Motor	1	1	1
04.MOT.009	Correa 14mts	1	1	1
04.MOT.010	Correa 30mts			
04.MOT.011	Conector Hoja	1	1	1
04.MOT.012	Eletrrocerradura	1	1	1
04.MOT.014	Transformador	1	1	1
04.MOT.016	Botonera	1	1	1
04.MOT.017	Gateway	1	1	1
04.AC.067	Kit Hoja Lateral	2	2	2
04.AC.082	Kit Hoja Central	2		
04.AC.083	Kit H.Central M.Inf. Oculto Tapas Aluminio		2	
04.AC.084	Kit H.Central M.Inf. Oculto Piso Corrido			2
04.AC.070	Tapa H.Lateral M.Inf. Oculto Tapas Aluminio		2	
04.AC.079	Tapa H.Lateral M.Inf. Oculto Piso Corrido			2
04.AC.071	Kit Cortavientos	1		
04.AC.080	Kit Cortavientos Marco Inferior Oculto		1	1
04.AC.085	Taco Estanq. M.Inf. Oculto Tapas Aluminio		1	
04.AC.086	Taco Estanq. M.Inf. Oculto Piso Corrido			1
04.AC.087	Cortavientos Hoja movil	1	1	1
04.TO.026	Tocho unión Marco	8	8	8
04.AC.F10	Felpudo Marco Sup/Inf	2L	L	5L
04.AC.F12	Felpudo Marco Lateral	2H	2H	2H
04.AC.F09	Felpudo Suplementos Hoja 16.349 y 16.651		2L	2L
04.JU.004.D	Junta Cierre Lateral	4H	4H	4H
04.JU.062	Junta Cruce Central	2H	2H	2H
04.JU.067	Junta Cruce Central	2H	2H	2H
04.JU.068	Junta Tapacanal Marco	L	L	L
04.JU.069	Junta Carril	x2	L-240	L-240
04.AC.R150	Carril Acero Inox.	x2	L-240	L-240
04.AC.R152	Rodamiento	2	2	2
04.AC.R153	Kit Angulo Rod. M.Inf. Oculto Tapas Aluminio		1	
04.AC.R154	Kit Angulo Rod. M.Inf. Oculto Piso Corrido			1
04.AC.074	Calzo Hoja Fija	2	2	2
04.JA.004	Junta Hoja Fija	2L+2H	L+2H	L+2H
04.TA.070	Tapa para Canaleta	2	2	2
04.TA.071	Tapa para Solera	2	2	2
04.AC.073	Calzo Vidrio	Según dimensiones de Vidrio		

*Se indica la longitud total necesaria. Las tapas se colocan en tramos para permitir el montaje.

El perfil 16.651 se coloca deslizado en la hoja inferior en 2 trozos, para permitir sacar la hoja del marco en caso de necesidad una vez colocado el piso.

En caso de piso corrido las tapas que ocultan el marco inferior deben de ser registrables para permitir sacar las hojas en caso de necesidad.

BALCONERA 2 HOJAS

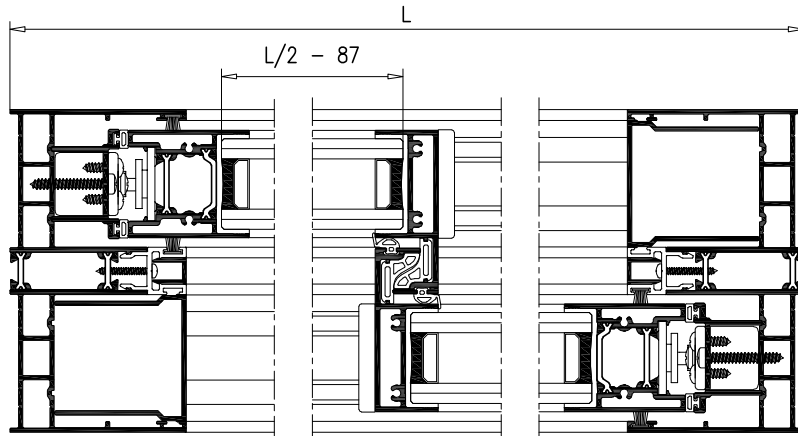
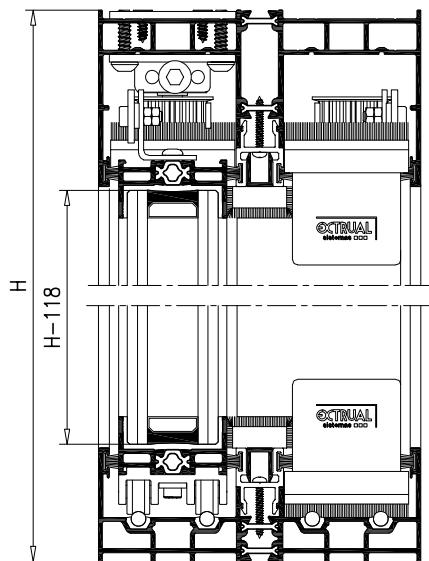

BALCONERA 2 HOJAS
Marco Inferior Oculto Tapas de Aluminio

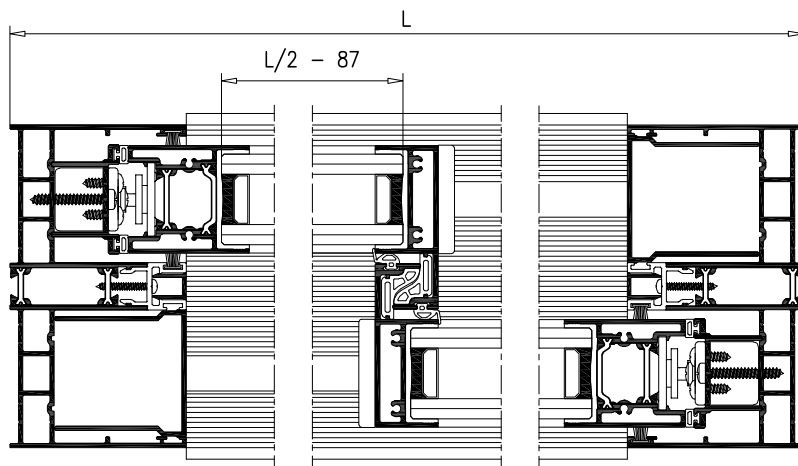
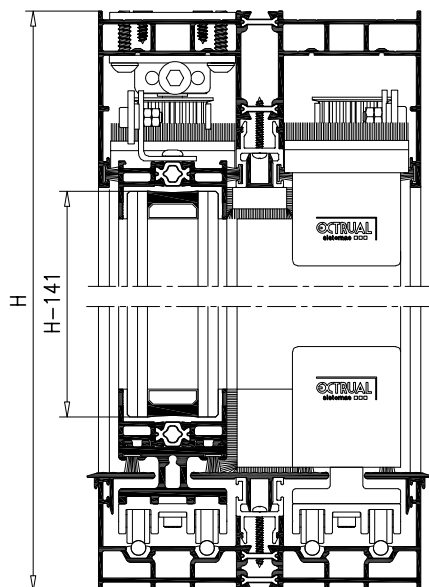



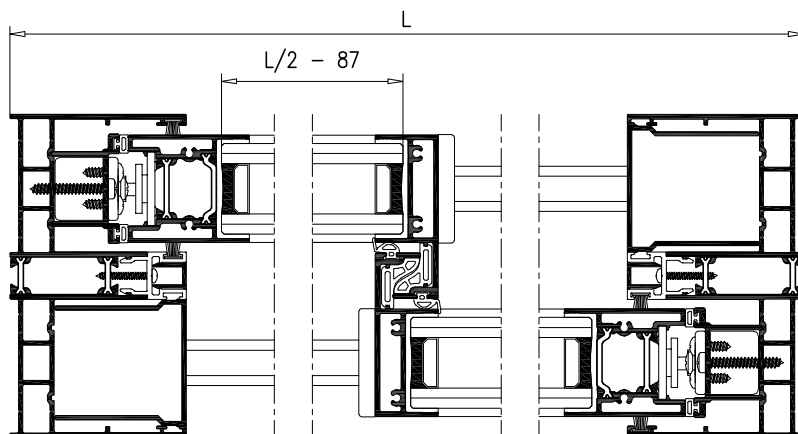
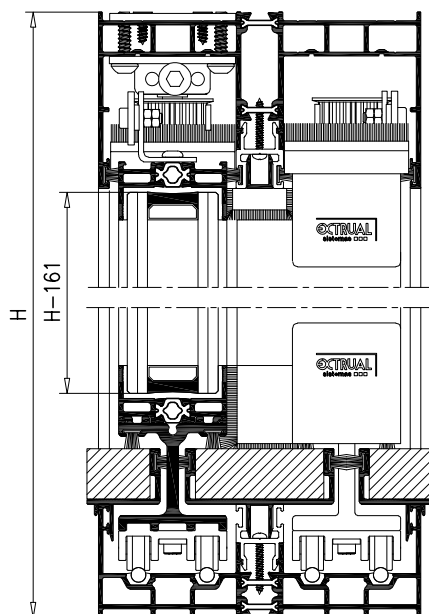



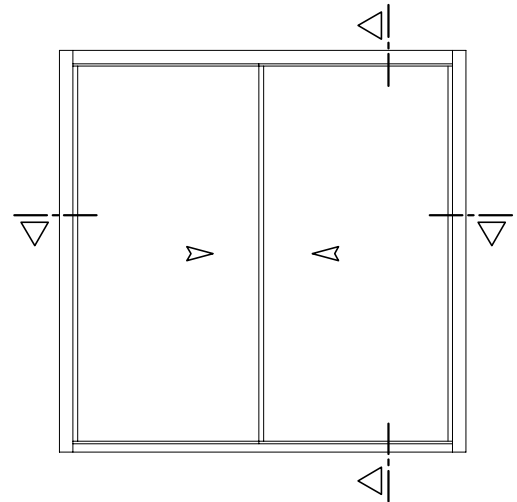



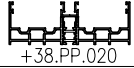



BALCONERA 2 HOJAS
Marco Inferior Oculto Piso Corrido



BALCONERA 2 HOJAS

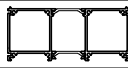

PERFILES

REFERENCIA	DENOMINACION	MARCO INFERIOR VISTO		MARCO INFERIOR OCULTO TAPAS ALUMINIO		MARCO INFERIOR OCULTO PISO CORRIDO	
		CANT.	CORTE	CANT.	CORTE	CANT.	CORTE
R-954	MARCO LAT/SUP  +38.PP.020	2 1	H L-140	2 1	H L-140	2 1	H L-140
R-941	MARCO INFERIOR  +38.PP.020	1	L-140	1	L-140	1	L-140
R-943	HOJA LATERAL 	2	H-140	2	H-163	2	H-183
R-945	HOJA SUP/INF 	4	(L/2)-47	4	(L/2)-47	4	(L/2)-47
16.349	SUPLEMENT. HOJA 			2	(L/2)-47		
16.651	SUPLEMENT. HOJA 					4	(L/4)-23.5
16.347	HOJA DE CIERRE 	2	H-140	2	H-163	2	H-183
16.857	CIERRE LATERAL 	2	H-75	2	H-114	2	H-134
16.342	TAPA CANAL 	2 4	H-96 (L/2)-83	2 2	H-96 (L/2)-83	2 2	H-96 (L/2)-83
16.858	TAPA MARCO LAT/SUP 	2	H-36	2	H-36	2	H-36
16.344*	TAPA CENTRAL 			1	L-140		
16.345*	TAPA LATERAL 			2	L-140		
16.652*	TAPA CENTRAL 					1	L-140
16.653*	TAPA LATERAL 					2	L-140
R-948	SOLERA 	1	L-4	1	L-4	1	L-4
15.686	TAPA CANALETA 	1	L-144	1	L-144		
16.351	CANALETA DRENAJE 	1	L-144	1	L-144	1	L-144

ACCESORIOS

REFERENCIA	DENOMINACION	M.INF. VISTO	M.INF. OCULTO TAPAS ALUMINIO	M.INF. OCULTO PISO CORRIDO
		UNIDADES	UNIDADES	UNIDADES
04.MOT.006	Kit Motor	2	2	2
04.MOT.009	Correa 14mts	1 ó 2	1 ó 2	1 ó 2
04.MOT.010	Correa 30mts			
04.MOT.011	Conector Hoja	2	2	2
04.MOT.012	Electrocerradura	2	2	2
04.MOT.015	Transformador	1	1	1
04.MOT.016	Botonera	2	2	2
04.MOT.017	Gateway	2	2	2
04.AC.067	Kit Hoja Lateral	2	2	2
04.AC.082	Kit Hoja Central	2		
04.AC.083	Kit H.Central M.Inf. Oculto Tapas Aluminio		2	
04.AC.084	Kit H.Central M.Inf. Oculto Piso Corrido			2
04.AC.070	Tapa H.Lateral M.Inf. Oculto Tapas Aluminio		2	
04.AC.079	Tapa H.Lateral M.Inf. Oculto Piso Corrido			2
04.AC.071	Kit Cortavientos	1		
04.AC.080	Kit Cortavientos Marco Inferior Oculto		1	1
04.AC.085	Taco Estanq. M.Inf. Oculto Tapas Aluminio		2	
04.AC.086	Taco Estanq. M.Inf. Oculto Piso Corrido			2
04.AC.087	Cortavientos Hoja movil	2	2	2
04.TO.026	Tocho unión Marco	8	8	8
04.AC.F10	Felpudo Marco Sup/Inf	4L	2L	6L
04.AC.F12	Felpudo Marco Lateral	4H	4H	4H
04.AC.F09	Felpudo Suplementos Hoja 16.349 y 16.651		2L	2L
04.JU.004.D	Junta Cierre Lateral	4H	4H	4H
04.JU.062	Junta Cruce Central	2H	2H	2H
04.JU.067	Junta Cruce Central	2H	2H	2H
04.JU.068	Junta Tapa canal Marco	1.5mts	1.5mts	1.5mts
04.JU.069	Junta Carril	x4	L-240	L-240
04.AC.R150	Carril Acero Inox.	x4	L-240	L-240
04.AC.R152	Rodamiento	4	4	4
04.AC.R153	Kit Angulo Rod. M.Inf. Oculto Tapas Aluminio		2	
04.AC.R154	Kit Angulo Rod. M.Inf. Oculto Piso Corrido			2
04.TA.070	Tapa para Canaleta	2	2	2
04.TA.071	Tapa para Solera	2	2	2
04.AC.073	Calzo Vidrio	Según dimensiones de Vidrio		

*Se indica la longitud total necesaria. Las tapas se colocan en tramos para permitir el montaje.

El perfil 16.651 se coloca deslizado en la hoja inferior en 2 trozos, para permitir sacar la hoja del marco en caso de necesidad una vez colocado el piso.

BALCONERA 2 HOJAS + FIJOS LATERALES

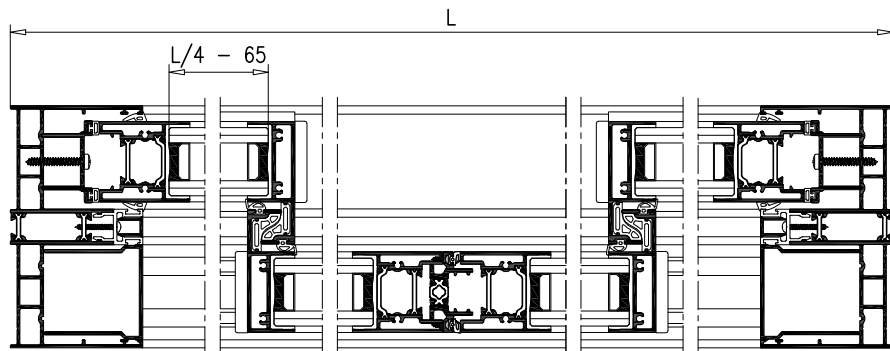
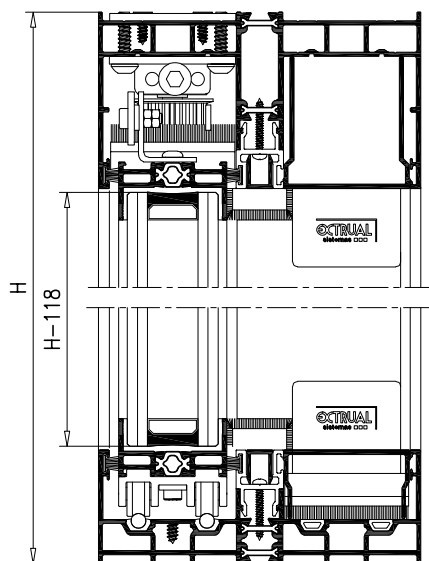

BALCONERA 2 HOJAS + FIJOS LATERALES
Marco Inferior Oculto Tapas de Aluminio

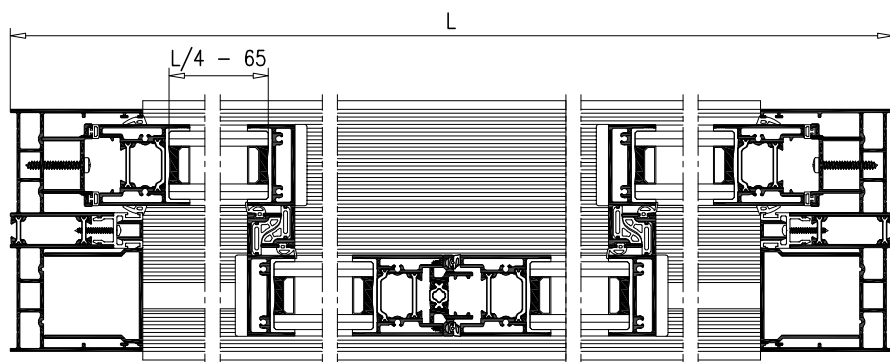
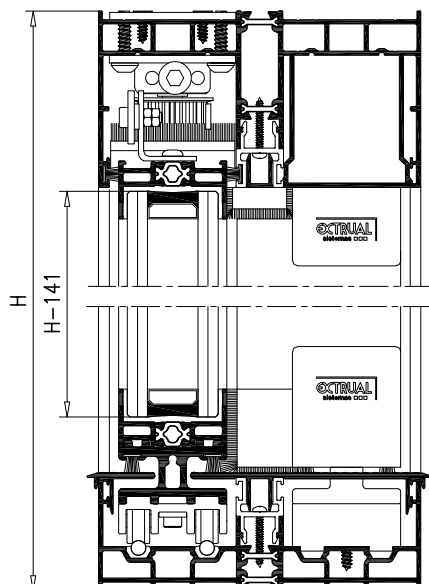

BALCONERA 2 HOJAS + FIJOS LATERALES
Marco Inferior Oculto Piso Corrido

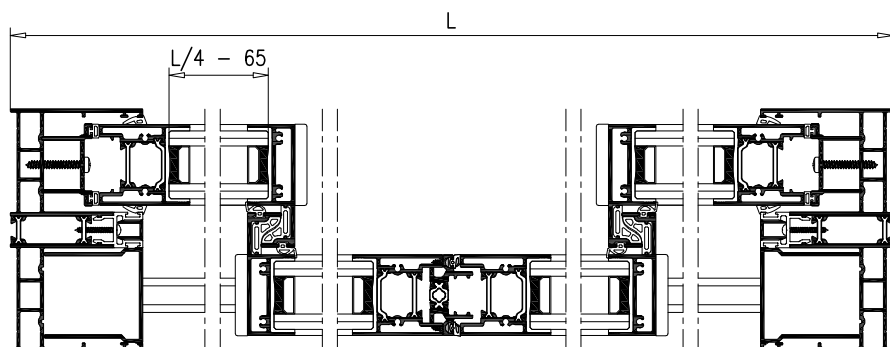
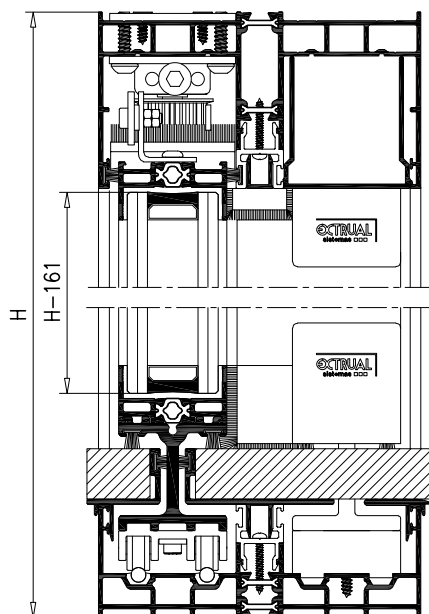

BALCONERA 2 HOJAS + FIJOS LATERALES

PERFILES

REFERENCIA	DENOMINACION	MARCO INFERIOR VISTO		MARCO INFERIOR OCULTO TAPAS ALUMINIO		MARCO INFERIOR OCULTO PISO CORRIDO	
		CANT.	CORTE	CANT.	CORTE	CANT.	CORTE
R-954	MARCO LAT/SUP +38.PP.020	2	H	2	H	2	H
		1	L-140	1	L-140	1	L-140
R-941	MARCO INFERIOR +38.PP.020	1	L-140	1	L-140	1	L-140
R-943	HOJA LATERAL	4	H-140	4	H-163	4	H-183
R-945	HOJA SUP/INF	8	(L/4)-25	8	(L/4)-25	8	(L/4)-25
16.349	SUPLEMENT. HOJA			4	(L/4)-25		
16.651	SUPLEMENT. HOJA					8	(L/8)-12.5
16.347	HOJA DE CIERRE	4	H-140	2	H-163	2	H-183
16.857	CIERRE LATERAL	2	H-75	2	H-114	2	H-134
R-946	CIERRE 4 HOJAS	1	H-94		H-119		H-139
16.342	TAPA CANAL	2	H-96	2	H-96	2	H-96
		4	(L/4)-61	2	(L/4)-61	2	(L/4)-61
		2	(L/2)-68	1	(L/2)-68	1	(L/2)-68
		2					
16.858	TAPA MARCO LAT/SUP	2	H-36	2	H-36	2	H-36
		1	(L/2)-68	1	(L/2)-68	1	(L/2)-68
16.343	TAPA MARCO INFERIOR	1	(L/2)-68				
16.344*	TAPA CENTRAL			2	(L/4)-32		
16.345*	TAPA LATERAL			2	(L/4)-32		(L/2)-76
		1		1	L-140		
16.346*	TAPA DOBLE			1	(L/2)-76		
16.652*	TAPA CENTRAL					1	(L/4)-32
16.653*	TAPA LATERAL					1	(L/4)-32
		1		1	L-140		
16.654*	TAPA MULTIPLE					1	(L/2)-76
R-948	SOLERA	1	L-4	1	L-4	1	L-4
15.686	TAPA CANALETA	1	L-144	1	L-144		
16.351	CANALETA DRENAJE	1	L-194	1	L-144	1	L-144

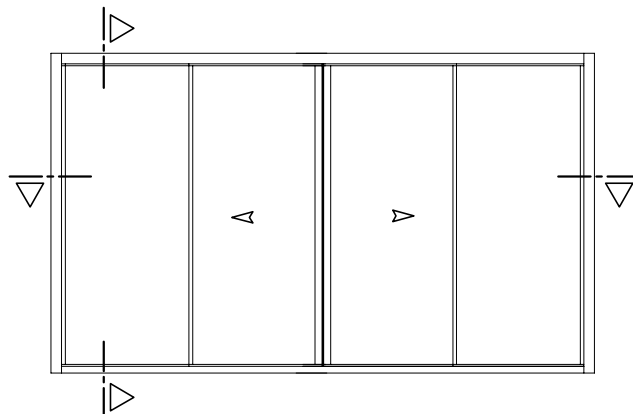

ACCESORIOS

REFERENCIA	DENOMINACION	M.INF. VISTO	M.INF. OCULTO TAPAS ALUMINIO	M.INF. OCULTO PISO CORRIDO
		UNIDADES	UNIDADES	UNIDADES
04.MOT.006	Kit Motor	2	2	2
04.MOT.009	Correa 14mts	1 6 2	1 6 2	1 6 2
04.MOT.010	Correa 30mts			
04.MOT.011	Conector Hoja	2	2	2
04.MOT.013	Electrocerradura	2	2	2
04.MOT.015	Transformador	1	1	1
04.MOT.016	Botonera	1	1	1
04.MOT.017	Gateway	1	1	1
04.AC.067	Kit Hoja Lateral	4	4	4
04.AC.082	Kit Hoja Central	4		
04.AC.083	Kit H.Central M.Inf. Oculto Tapas Aluminio		4	
04.AC.084	Kit H.Central M.Inf. Oculto Piso Corrido			4
04.AC.070	Tapa H.Lateral M.Inf. Oculto Tapas Aluminio		4	
04.AC.079	Tapa H.Lateral M.Inf. Oculto Piso Corrido			4
04.AC.071	Kit Cortavientos	2		
04.AC.080	Kit Cortavientos Marco Inferior Oculto		2	2
04.AC.076	Tope Inf. 4 Hojas Marco Infe. Oculto		1	1
04.AC.085	Taco Estanq. M.Inf. Oculto Tapas Aluminio		2	
04.AC.086	Taco Estanq. M.Inf. Oculto Piso Corrido			2
04.AC.087	Cortavientos Hoja movil	2	2	2
04.TO.026	Tocho unión Marco	8	8	8
04.AC.F10	Felpudo Marco Sup/Inf	2L	L	5L
04.AC.F09	Felpudo Suplementos Hoja 16.349 y 16.651		L	L
04.JU.004.D	Junta Cierre Lateral	4H	4H	4H
04.JU.004.E	Junta Cierre 4 Hojas	2H	2H	2H
04.JU.062	Junta Cruce Central	4H	4H	4H
04.JU.067	Junta Cruce Central	4H	4H	4H
04.JU.068	Junta Tapacanal Marco	2L	2L	2L
04.JU.069	Junta Carril	x2	L-240	L-240
04.AC.R150	Carril Acero Inox.	x2	L-240	L-240
04.AC.R152	Rodamiento	4	4	4
04.AC.R153	Kit Angulo Rod. M.Inf. Oculto Tapas Aluminio		2	
04.AC.R154	Kit Angulo Rod. M.Inf. Oculto Piso Corrido			2
04.AC.074	Calzo Hoja Fija	4	4	4
04.JA.004	Junta Hoja Fija	2L+4H	L+4H	L+4H
04.TA.070	Tapa para Canaleta	2	2	2
04.TA.071	Tapa para Solera	2	2	2
04.AC.073	Calzo Vidrio	Según dimensiones de Vidrio		

*Se indica la longitud total necesaria. Las tapas se colocan en tramos para permitir el montaje.

El perfil 16.651 se coloca deslizado en la hoja inferior en 2 trozos, para permitir sacar la hoja del marco en caso de necesidad una vez colocado el piso.

En caso de piso corrido las tapas que ocultan el marco inferior deben de ser registrables para permitir sacar las hojas en caso de necesidad.

BALCONERA 2 HOJAS + FIJO

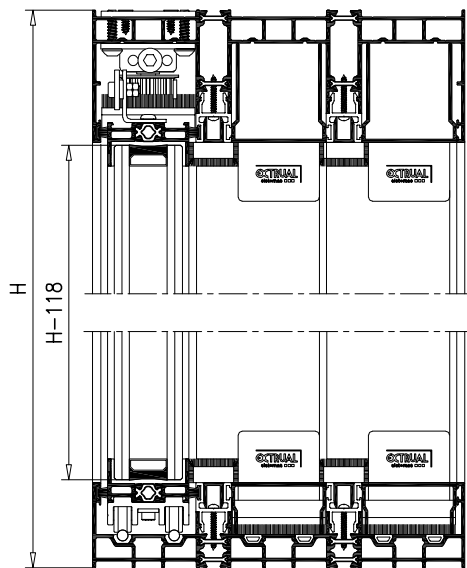

BALCONERA 2 HOJAS + FIJO
Marco Inferior Oculto Tapas de Aluminio

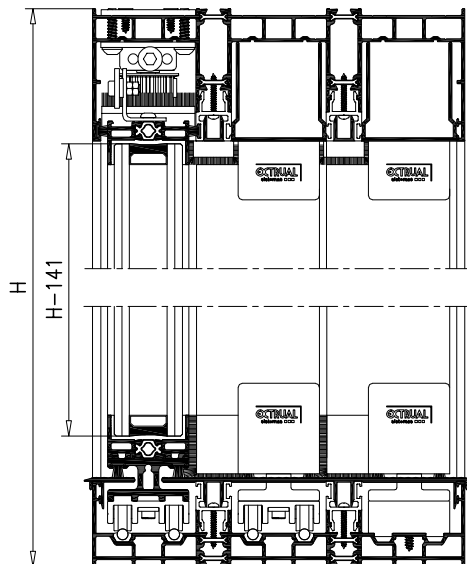

BALCONERA 2 HOJAS + FIJO
Marco Inferior Oculto Piso Corrido

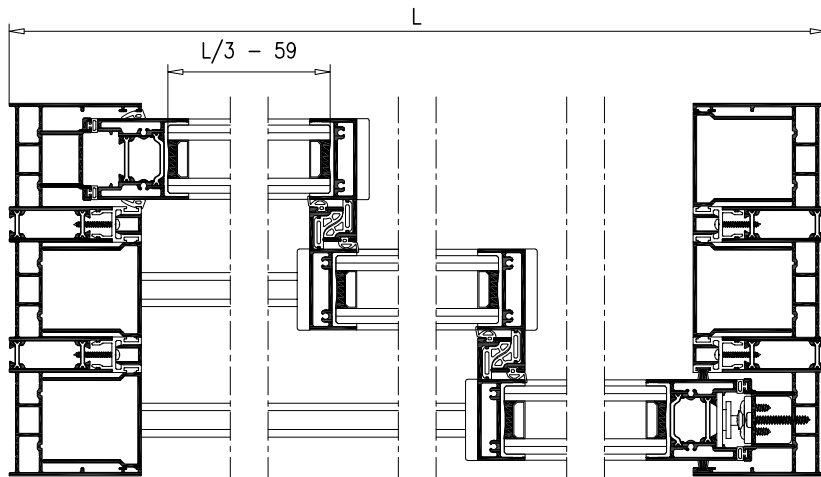
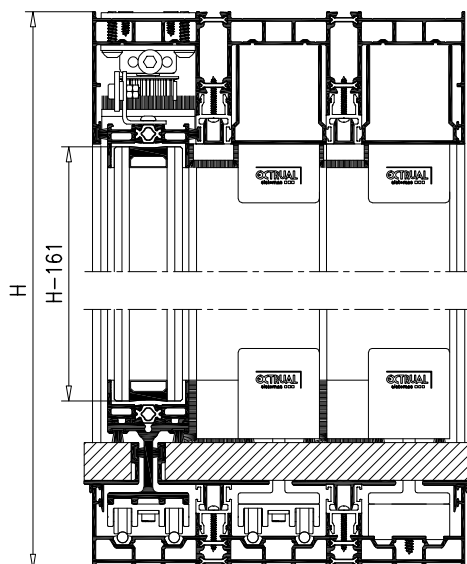

BALCONERA 2 HOJAS + FIJO

PERFILES

REFERENCIA	DENOMINACION	MARCO INFERIOR VISTO		MARCO INFERIOR OCULTO TAPAS ALUMINIO		MARCO INFERIOR OCULTO PISO CORRIDO	
		CANT.	CORTE	CANT.	CORTE	CANT.	CORTE
R-955	MARCO LAT/SUP +38.PP.020 (x2)	2	H	2	H	2	H
		1	L-140	1	L-140	1	L-140
R-942	MARCO INFERIOR +38.PP.020 (x2)	1	L-140	1	L-140	1	L-140
R-943	HOJA LATERAL	2	H-140	2	H-163	2	H-183
R-945	HOJA SUP/INF	4	(L/3)-19	4	(L/3)-19	4	(L/3)-19
		2	(L/3)-31	2	(L/3)-31	2	(L/3)-31
16.349	SUPLEMENT. HOJA			2	(L/3)-19		
				1	(L/3)-31		
16.651	SUPLEMENT. HOJA					2	(L/3)-19
						1	(L/3)-31
16.347	HOJA DE CIERRE	4	H-140	4	H-163	4	H-183
16.857	CIERRE LATERAL	2	H-75	1	H-114	1	H-134
16.342	TAPA CANAL	4	H-96	4	H-96	4	H-96
		4	(L/3)-55	2	(L/3)-55	2	(L/3)-55
		4	(2L/3)-110	2	(2L/3)-110	2	(2L/3)-110
16.858	TAPA MARCO LAT/SUP	4	H-75	4	H-75	4	H-75
		1	(L/3)-55	1	(L/3)-55	1	(L/3)-55
		1	(2L/3)-110	1	(2L/3)-110	1	(2L/3)-110
16.343	TAPA MARCO INFERIOR	1	(L/3)-55				
		1	(2L/3)-110				
16.344*	TAPA CENTRAL			1	(L/3)-26	1	(L/3)-59
				1	(2L/3)-82		
16.345*	TAPA LATERAL			1	(L/3)-26	1	(2L/3)-115
				1	L-140		
16.346*	TAPA DOBLE			1	(L/3)-56		
16.608*	TAPA TRIPLE			1	(L/3)-59		
16.652*	TAPA CENTRAL					1	(L/3)-26
						1	(2L/3)-82
16.653*	TAPA LATERAL					1	(L/3)-26
						1	L-140
16.654*	TAPA MULTIPLE					1	(L/3)-56
						1	(L/3)-59
R-949	SOLERA	1	L-4	1	L-4	1	L-4
15.686	TAPA CANALETA	1	L-144	1	L-144		
16.351	CANALETA DRENAJE	1	L-194	1	L-144	1	L-144

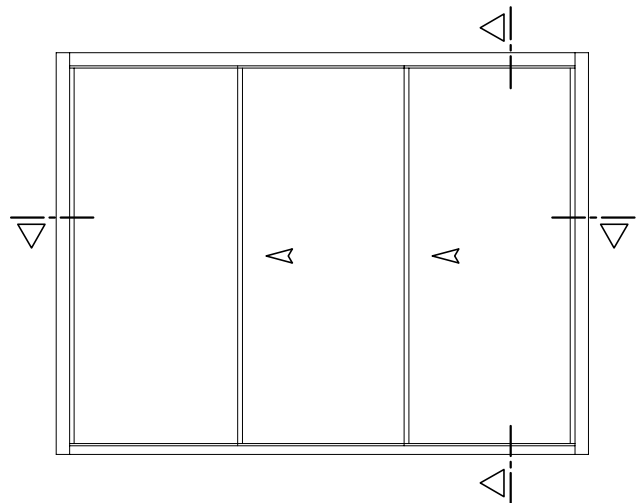

ACCESORIOS

REFERENCIA	DENOMINACION	M.INF. VISTO	M.INF. OCULTO TAPAS ALUMINIO	M.INF. OCULTO PISO CORRIDO
		UNIDADES	UNIDADES	UNIDADES
04.MOT.006	Kit Motor	2	2	2
04.MOT.009	Correa 14mts	1 6 2	1 6 2	1 6 2
04.MOT.010	Correa 30mts			
04.MOT.011	Conector Hoja	2	2	2
04.MOT.012	Electrocerradura	1	1	1
04.MOT.015	Transformador	1	1	1
04.MOT.016	Botonera	1	1	1
04.MOT.017	Gateway	1	1	1
04.AC.067	Kit Hoja Lateral	2	2	2
04.AC.082	Kit Hoja Central	4		
04.AC.083	Kit H.Central M.Inf. Oculto Tapas Aluminio		4	
04.AC.084	Kit H.Central M.Inf. Oculto Piso Corrida			4
04.AC.070	Tapa H.Lateral M.Inf. Oculto Tapas Aluminio		2	
04.AC.079	Tapa H.Lateral M.Inf. Oculto Piso Corrida			2
04.AC.071	Kit Cortavientos	2		
04.AC.080	Kit Cortavientos Marco Inferior Oculto		2	2
04.AC.085	Taco Estanq. M.Inf. Oculto Tapas Aluminio		2	
04.AC.086	Taco Estanq. M.Inf. Oculto Piso Corrida			2
04.AC.087	Cortavientos Hoja movil	2	2	2
04.TO.026	Tocho unión Marco	12	12	12
04.AC.F10	Felpudo Marco Sup/Inf	3L	1,5L	6L
04.AC.F12	Felpudo Marco Lateral	2H	2H	2H
04.AC.F09	Felpudo Suplementos Hoja 16.349 y 16.651		2L	2L
04.JU.004.D	Junta Cierre Lateral	4H	4H	4H
04.JU.062	Junta Cruce Central	4H	4H	4H
04.JU.067	Junta Cruce Central	4H	4H	4H
04.JU.068	Junta Tapacanal Marco	2L	2L	2L
04.JU.069	Junta Carril	x4	L-240	L-240
04.AC.R150	Carril Acero Inox.	x4	L-240	L-240
04.AC.R152	Rodamiento	4	4	4
04.AC.R153	Kit Angulo Rod. M.Inf. Oculto Tapas Aluminio		2	
04.AC.R154	Kit Angulo Rod. M.Inf. Oculto Piso Corrida			2
04.AC.074	Calzo Hoja Fija	2	2	2
04.JA.004	Junta Hoja Fija	L+2H	L+2H	L+2H
04.TA.070	Tapa para Canaleta	2	2	2
04.TA.071	Tapa para Solera	2	2	2
04.AC.073	Calzo Vidrio	Según dimensiones de Vidrio		

*Se indica la longitud total necesaria. Las tapas se colocan en tramos para permitir el montaje.

En caso de piso corrido las tapas que ocultan el marco inferior deben de ser registrables para permitir sacar las hojas en caso de necesidad.

BALCONERA 2 HOJAS + FIJO CENTRAL

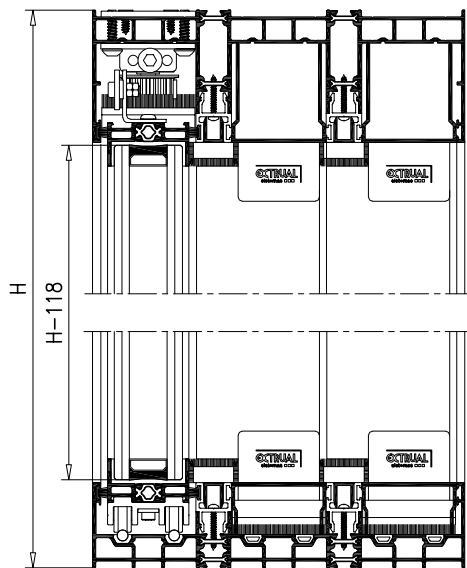

BALCONERA 2 HOJAS + FIJO CENTRAL
Marco Inferior Oculto Tapas de Aluminio

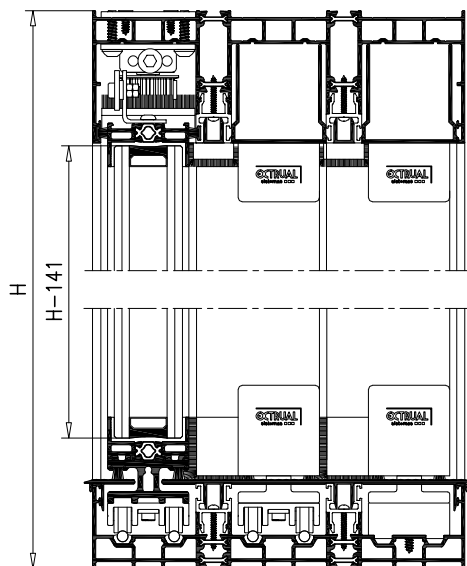



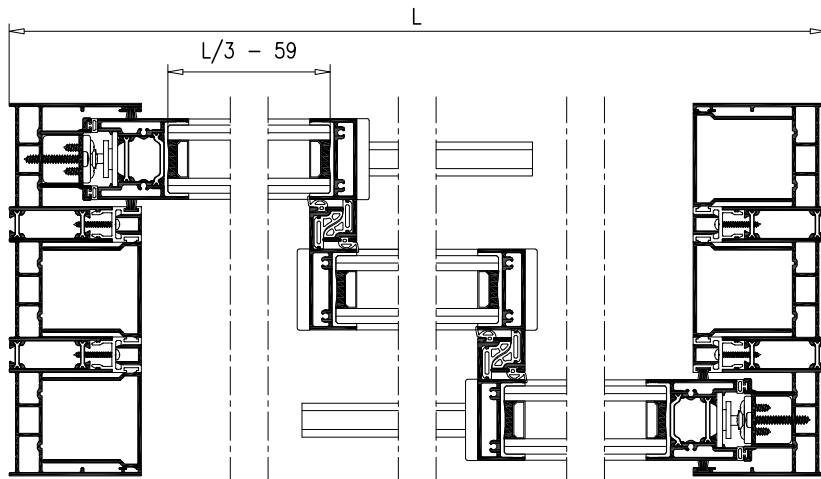
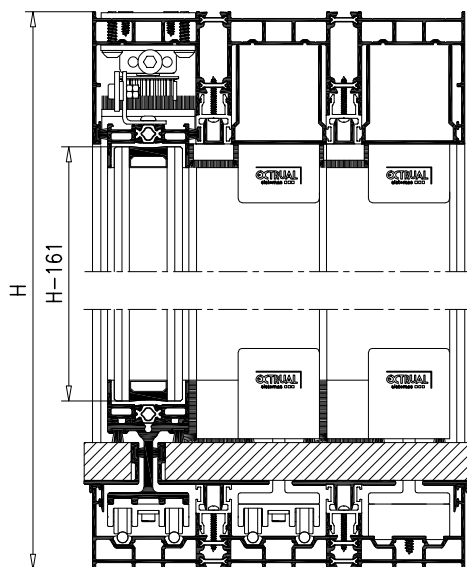

















BALCONERA 2 HOJAS + FIJO CENTRAL
Marco Inferior Oculto Piso Corrido

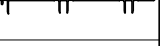

BALCONERA 2 HOJAS + FIJO CENTRAL

PERFILES

REFERENCIA	DENOMINACION	MARCO INFERIOR VISTO		MARCO INFERIOR OCULTO TAPAS ALUMINIO		MARCO INFERIOR OCULTO PISO CORRIDO		
		CANT.	CORTE	CANT.	CORTE	CANT.	CORTE	
R-955	 +38.PP.020 (x2)	MARCO LAT/SUP	2	H	2	H	2	H
			1	L-140	1	L-140	1	L-140
R-942	 +38.PP.020 (x2)	MARCO INFERIOR	1	L-140	1	L-140	1	L-140
R-943		HOJA LATERAL	2	H-140	2	H-163	2	H-183
R-945		HOJA SUP/INF	4	(L/3)-19	4	(L/3)-19	4	(L/3)-19
			2	(L/3)-31	2	(L/3)-31	2	(L/3)-31
16.349		SUPLEMENT. HOJA			2	(L/3)-19		
					1	(L/3)-31		
16.651		SUPLEMENT. HOJA					2	(L/3)-19
							1	(L/3)-31
16.347		HOJA DE CIERRE	4	H-140	4	H-163	4	H-183
16.857		CIERRE LATERAL	2	H-75	1	H-114	1	H-134
16.342		TAPA CANAL	4	H-96	4	H-96	4	H-96
			4	(L/3)-55	2	(L/3)-55	2	(L/3)-55
			4	(2L/3)-110	2	(2L/3)-110	2	(2L/3)-110
16.858		TAPA MARCO LAT/SUP	4	H-36	4	H-36	4	H-36
			4	(L/3)-55	4	(L/3)-55	4	(L/3)-55
16.343		TAPA MARCO INFERIOR	4	(L/3)-55				
16.344*		TAPA CENTRAL			2	(L/3)-23		
16.345*		TAPA LATERAL			2	(2L/3)-82		
16.346*		TAPA DOBLE					2	(L/3)-59
16.608*		TAPA TRIPLE			2	(L/3)-59		
16.652*		TAPA CENTRAL					2	(L/3)-23
16.653*		TAPA LATERAL					2	(2L/3)-82
16.654*		TAPA MULTIPLE					2	(L/3)-59
R-949		SOLERA	1	L-4	1	L-4	1	L-4
15.686		TAPA CANALETA	1	L-144	1	L-144		
16.351		CANALETA DRENAJE	1	L-194	1	L-144	1	L-144

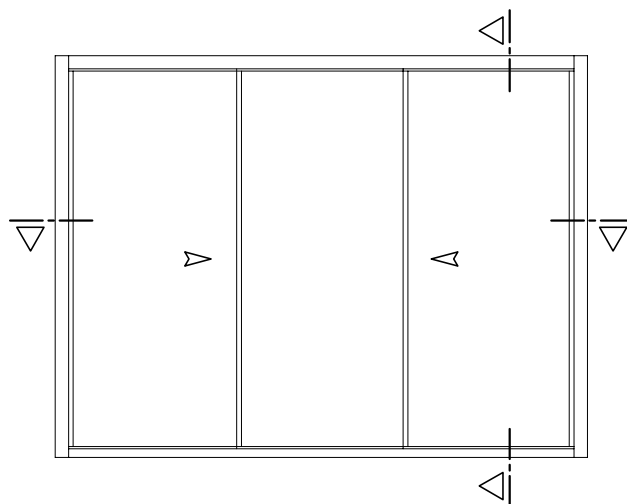

ACCESORIOS

REFERENCIA	DENOMINACION	M.INF. VISTO	M.INF. OCULTO TAPAS ALUMINIO	M.INF. OCULTO PISO CORRIDO
		UNIDADES	UNIDADES	UNIDADES
04.MOT.006	Kit Motor	2	2	2
04.MOT.009	Correa 14mts	1 6 2	1 6 2	1 6 2
04.MOT.010	Correa 30mts			
04.MOT.011	Conector Hoja	2	2	2
04.MOT.012	Eletrrocerradura	2	2	2
04.MOT.015	Transformador	1	1	1
04.MOT.016	Botonera	2	2	2
04.MOT.017	Gateway	2	2	2
04.AC.067	Kit Hoja Lateral	2	2	2
04.AC.082	Kit Hoja Central	4		
04.AC.083	Kit H.Central M.Inf. Oculto Tapas Aluminio		4	
04.AC.084	Kit H.Central M.Inf. Oculto Piso Corrido			4
04.AC.070	Tapa H.Lateral M.Inf. Oculto Tapas Aluminio		2	
04.AC.079	Tapa H.Lateral M.Inf. Oculto Piso Corrido			2
04.AC.071	Kit Cortavientos	2		
04.AC.080	Kit Cortavientos Marco Inferior Oculto		2	2
04.AC.085	Taco Estanq. M.Inf. Oculto Tapas Aluminio		2	
04.AC.086	Taco Estanq. M.Inf. Oculto Piso Corrido			2
04.AC.087	Cortavientos Hoja movil	2	2	2
04.TO.026	Tocho unión Marco	12	12	12
04.AC.F10	Felpudo Marco Sup/Inf	3H	1,5L	4,5L
04.AC.F12	Felpudo Marco Lateral	4H	4H	6L
04.AC.F09	Felpudo Suplementos Hoja 16.349 y 16.651		1,5L	1,5L
04.JU.004.D	Junta Cierre Lateral	4H	4H	4H
04.JU.062	Junta Cruce Central	4H	4H	4H
04.JU.067	Junta Cruce Central	4H	4H	4H
04.JU.068	Junta Tapa canal Marco	3L	3L	3L
04.JU.069	Junta Carril	3L	3L	3L
04.AC.R150	Carril Acero Inox.	3L	3L	3L
04.AC.R152	Rodamiento	4	4	4
04.AC.R153	Kit Angulo Rod. M.Inf. Oculto Tapas Aluminio		2	
04.AC.R154	Kit Angulo Rod. M.Inf. Oculto Piso Corrido			2
04.AC.074	Calzo Hoja Fija	2	2	2
04.JA.004	Junta Hoja Fija	1,5L	1,5L	1,5L
04.TA.070	Tapa para Canaleta	2	2	2
04.TA.071	Tapa para Solera	2	2	2
04.AC.073	Calzo Vidrio	Según dimensiones de Vidrio		

*Se indica la longitud total necesaria. Las tapas se colocan en tramos para permitir el montaje.

En caso de piso corrido las tapas que ocultan el marco inferior deben de ser registrables para permitir sacar las hojas en caso de necesidad.

BALCONERA 3 HOJAS

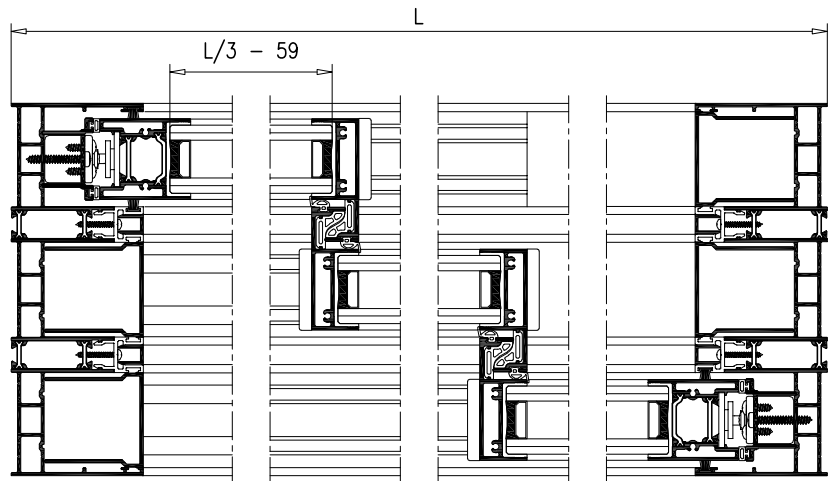
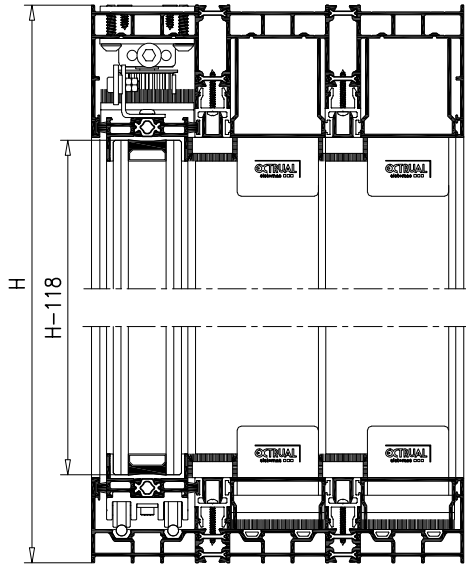

BALCONERA 3 HOJAS
Marco Inferior Oculto Tapas de Aluminio

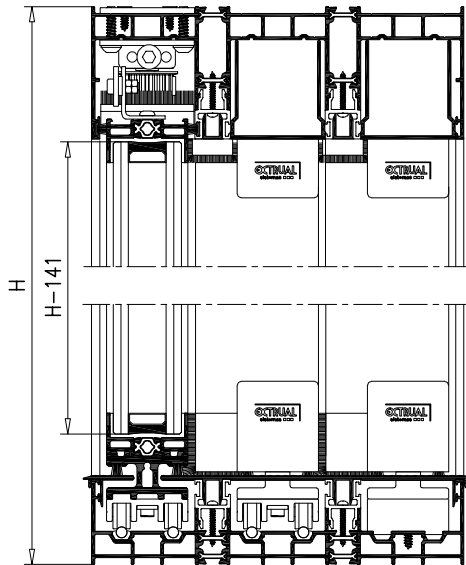

BALCONERA 3 HOJAS
Marco Inferior Oculto Piso Corrido

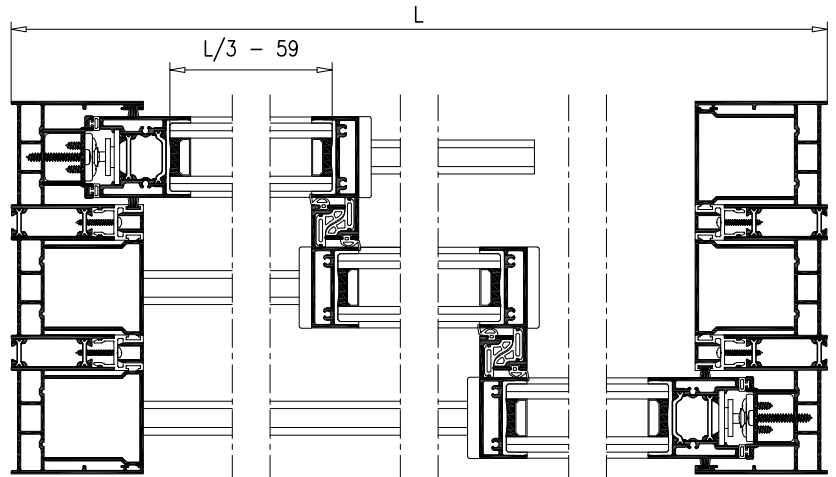
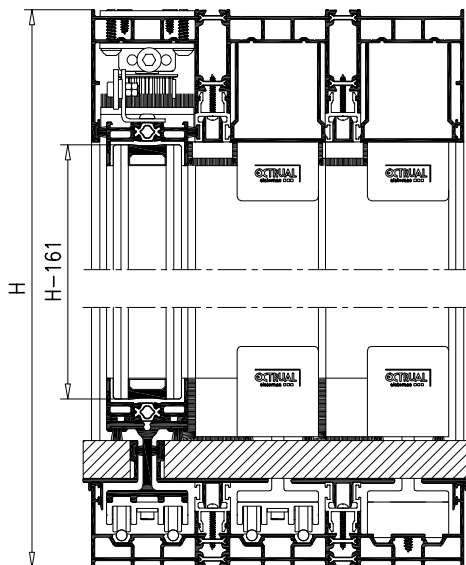

BALCONERA 3 HOJAS

PERFILES

REFERENCIA	DENOMINACION	MARCO INFERIOR VISTO		MARCO INFERIOR OCULTO TAPAS ALUMINIO		MARCO INFERIOR OCULTO PISO CORRIDO	
		CANT.	CORTE	CANT.	CORTE	CANT.	CORTE
R-955	MARCO LAT/SUP +38.PP.020 (x2)	2	H	2	H	2	H
		1	L-140	1	L-140	1	L-140
R-942	MARCO INFERIOR +38.PP.020 (x2)	1	L-140	1	L-140	1	L-140
R-943	HOJA LATERAL	2	H-140	2	H-163	2	H-183
R-945	HOJA SUP/INF	4	(L/3)-19	4	(L/3)-19	4	(L/3)-19
		2	(L/3)-31	2	(L/3)-31	2	(L/3)-31
16.349	SUPLEMENT. HOJA			2	(L/3)-19		
				1	(L/3)-31		
16.651	SUPLEMENT. HOJA					2	(L/3)-19
						1	(L/3)-31
16.347	HOJA DE CIERRE	4	H-140	4	H-163	4	H-183
16.857	CIERRE LATERAL	2	H-75	1	H-114	1	H-134
16.342	TAPA CANAL	4	H-96	4	H-96	4	H-96
		4	(L/3)-55	2	(L/3)-55	2	(L/3)-55
		4	(2L/3)-110	2	(2L/3)-110	2	(2L/3)-110
16.858	TAPA MARCO LAT/SUP	4	H-36	4	H-36	4	H-36
		2	(L/3)-55	2	(L/3)-55	2	(L/3)-55
16.343	TAPA MARCO INFERIOR	2	(L/3)-55				
16.344*	TAPA CENTRAL			2	(2L/3)-82		
16.345*	TAPA LATERAL			1	(2L/3)-82		
				1	L-140		
16.346*	TAPA DOBLE					1	(L/3)-59
16.608*	TAPA TRIPLE			1	(L/3)-59		
16.652*	TAPA CENTRAL					2	(2L/3)-82
16.653*	TAPA LATERAL					1	(2L/3)-82
						1	L-140
16.654*	TAPA MULTIPLE					2	(L/3)-59
R-949	SOLERA	1	L-4	1	L-4	1	L-4
15.686	TAPA CANALETA	1	L-144	1	L-144		
16.351	CANALETA DRENAJE	1	L-194	1	L-144	1	L-144

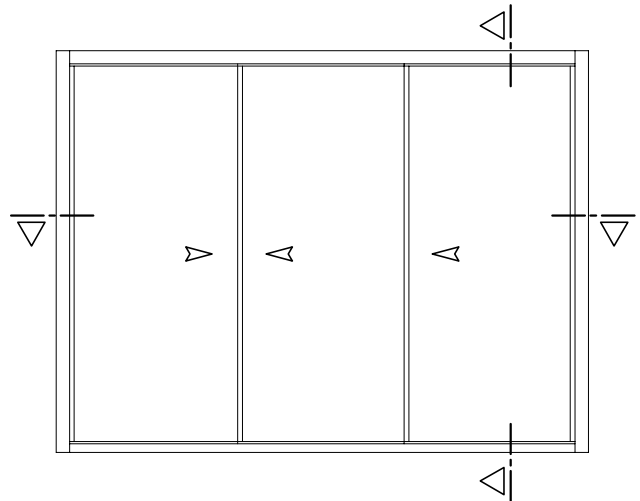

ACCESORIOS

REFERENCIA	DENOMINACION	M.INF. VISTO	M.INF. OCULTO TAPAS ALUMINIO	M.INF. OCULTO PISO CORRIDO
		UNIDADES	UNIDADES	UNIDADES
04.MOT.006	Kit Motor	3	3	3
04.MOT.009	Correa 14mts	2 6 3	2 6 3	2 6 3
04.MOT.010	Correa 30mts			
04.MOT.011	Conector Hoja	3	3	3
04.MOT.012	Electrocerradura	2	2	2
04.MOT.014	Transformador 100W	1	1	1
04.MOT.015	Transformador 200W	1	1	1
04.MOT.016	Botonera	2	2	2
04.MOT.017	Gateway	2	2	2
04.AC.067	Kit Hoja Lateral	2	2	1
04.AC.082	Kit Hoja Central	4		
04.AC.083	Kit H.Central M.Inf. Oculto Tapas Aluminio		4	
04.AC.084	Kit H.Central M.Inf. Oculto Piso Corrido			4
04.AC.070	Tapa H.Lateral M.Inf. Oculto Tapas Aluminio		2	
04.AC.079	Tapa H.Lateral M.Inf. Oculto Piso Corrido			2
04.AC.071	Kit Cortavientos	2		
04.AC.080	Kit Cortavientos Marco Inferior Oculto		2	2
04.AC.085	Taco Estanq. M.Inf. Oculto Tapas Aluminio		2	
04.AC.086	Taco Estanq. M.Inf. Oculto Piso Corrido			2
04.AC.087	Cortavientos Hoja movil	2	2	2
04.TO.026	Tocho unión Marco	12	12	12
04.AC.F10	Felpudo Marco Sup/Inf	4L	2L	7L
04.AC.F12	Felpudo Marco Lateral	4H	4H	4H
04.AC.F09	Felpudo Suplementos Hoja 16.349 y 16.651		2L	2L
04.JU.004.D	Junta Cierre Lateral	4H	4H	4H
04.JU.062	Junta Cruce Central	4H	4H	4H
04.JU.067	Junta Cruce Central	4H	4H	4H
04.JU.068	Junta Tapa canal Marco	L	L	L
04.JU.069	Junta Carril	x6	L-240	L-240
04.AC.R150	Carril Acero Inox.	x6	L-240	L-240
04.AC.R152	Rodamiento	6	6	6
04.AC.R153	Kit Angulo Rod. M.Inf. Oculto Tapas Aluminio		3	
04.AC.R154	Kit Angulo Rod. M.Inf. Oculto Piso Corrido			3
04.TA.070	Tapa para Canaleta	2	2	2
04.TA.071	Tapa para Solera	2	2	2
04.AC.073	Calzo Vidrio	Según dimensiones de Vidrio		

*Se indica la longitud total necesaria. Las tapas se colocan en tramos para permitir el montaje.

BALCONERA 4 HOJAS + 2 FIJOS

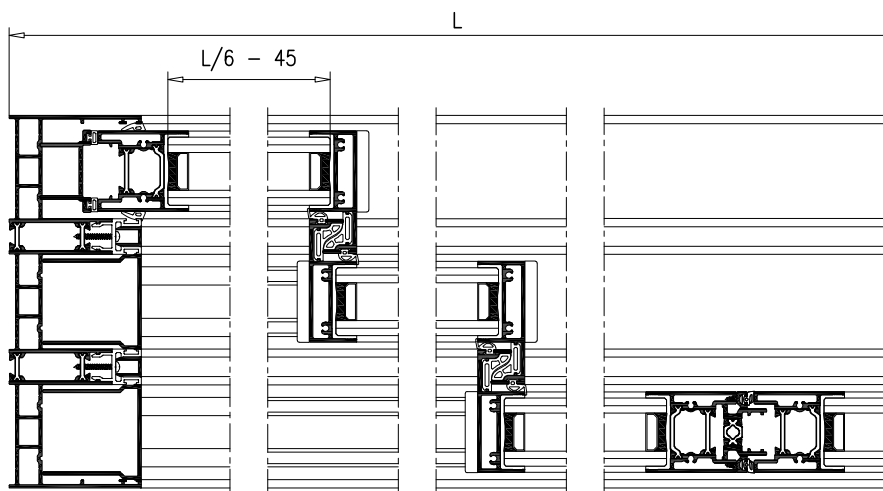
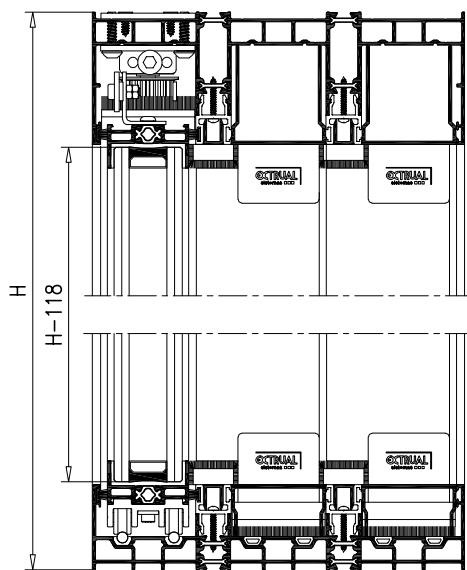

BALCONERA 4 HOJAS + 2 FIJOS
Marco Inferior Oculto Tapas de Aluminio

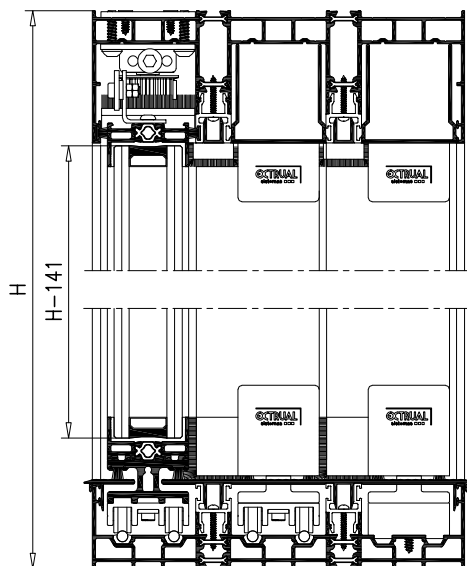

BALCONERA 4 HOJAS + 2 FIJOS
Marco Inferior Oculto Piso Corrido

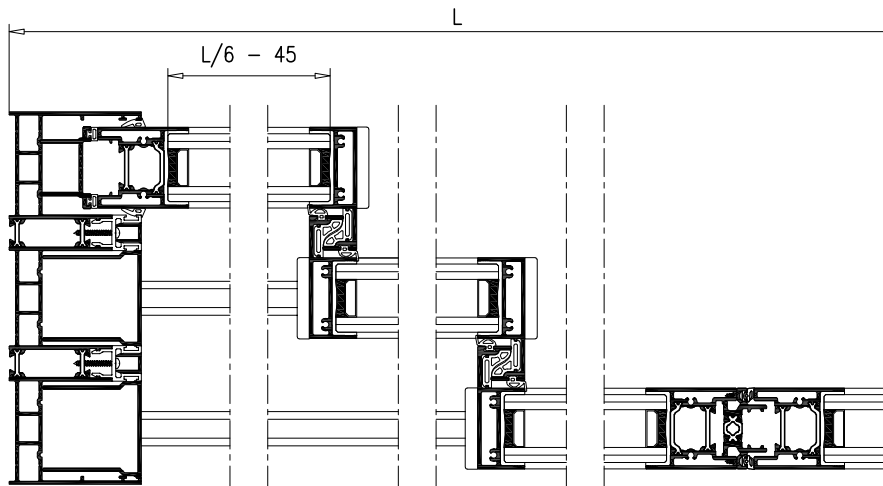
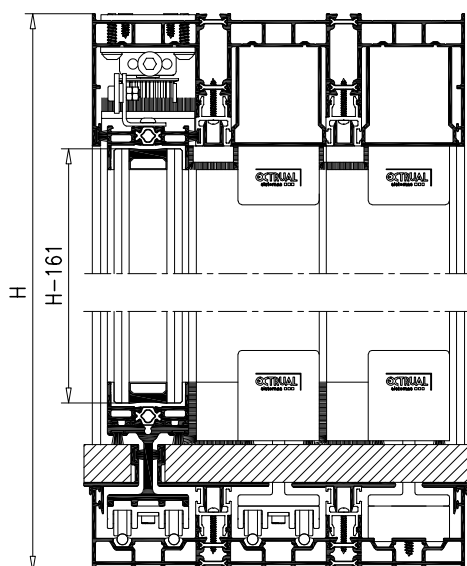

PERFILES

REFERENCIA	DENOMINACION	MARCO INFERIOR VISTO		MARCO INFERIOR OCULTO TAPAS ALUMINIO		MARCO INFERIOR OCULTO PISO CORRIDO	
		CANT.	CORTE	CANT.	CORTE	CANT.	CORTE
R-955	MARCO LAT/SUP +38.PP.020 (x2)	2	H	2	H	2	H
		1	L-140	1	L-140	1	L-140
R-942	MARCO INFERIOR +38.PP.020 (x2)	1	L-140	1	L-140	1	L-140
R-943	HOJA LATERAL	4	H-140	4	H-163	4	H-183
R-945	HOJA SUP/INF	8	(L/6)-5	8	(L/6)-5	8	(L/6)-5
		4	(L/6)-17	4	(L/6)-17	4	(L/6)-17
16.349	SUPLEMENT. HOJA			4	(L/6)-5		
				2	(L/6)-17		
16.651	SUPLEMENT. HOJA					4	(L/6)-5
						2	(L/6)-17
16.347	HOJA DE CIERRE	8	H-140	8	H-163	8	H-183
16.857	CIERRE LATERAL	2	H-75	1	H-114	1	H-134
R-946	CIERRE 4 HOJAS	1	H-94	1	H-119	1	H-139
16.342	TAPA CANAL	4	H-96	4	H-96	4	H-96
		4	(L/6)-41	2	(L/6)-41	2	(L/6)-41
		4	(L/3)-82	2	(L/3)-82	2	(L/3)-82
		2	(4L/6)-109	1	(4L/6)-109	1	(4L/6)-109
		2	(L/3)-27	1	(L/3)-27	1	(L/3)-27
16.858	TAPA MARCO LAT/SUP	4	H-75	4	H-75	4	H-75
		1	(4L/6)-109	1	(4L/6)-109	1	(4L/6)-109
		1	(L/3)-27	1	(L/3)-27	1	(L/3)-27
16.343	TAPA MARCO INFERIOR	1	(4L/6)-109				
		1	(L/3)-27				
16.344*	TAPA CENTRAL			2	(L/6)-12		
				2	(L/3)-53		
16.345*	TAPA LATERAL			2	(L/6)-12		(L/6)-42
				1	L-140		
16.346*	TAPA DOBLE			2	(L/6)-42	1	(L/3)-35
16.608*	TAPA TRIPLE			1	(L/3)-35		
16.652*	TAPA CENTRAL					2	(L/6)-12
						2	(L/3)-53
16.653*	TAPA LATERAL					2	(L/6)-12
				1	L-140		
16.654*	TAPA MULTIPLE					2	(L/6)-42
				1	(L/3)-35		
R-949	SOLERA	1	L-4	1	L-4	1	L-4
15.686	TAPA CANALETA	1	L-144	1	L-144		
16.351	CANALETA DRENAJE	1	L-194	1	L-144	1	L-144

BALCONERA 4 HOJAS + 2 FIJOS

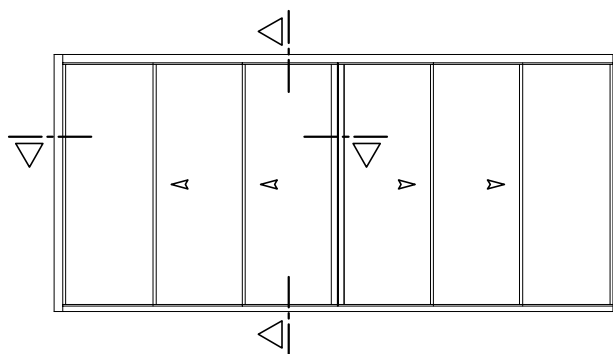

Aperturas independientes (2 pulsadores)

ACCESORIOS

REFERENCIA	DENOMINACION	M.INF. VISTO	M.INF. OCULTO TAPAS ALUMINIO	M.INF. OCULTO PISO CORRIDO
		UNIDADES	UNIDADES	UNIDADES
04.MOT.006	Kit Motor	4	4	4
04.MOT.009	Correa 14mts	2 6 4	2 6 4	2 6 4
04.MOT.010	Correa 30mts			
04.MOT.011	Conector Hoja	4	4	4
04.MOT.013	Electrocerradura	2	2	2
04.MOT.015	Transformador	2	2	2
04.MOT.016	Botonera	2	2	2
04.MOT.017	Gateway	2	2	2
04.AC.067	Kit Hoja Lateral	4	4	4
04.AC.082	Kit Hoja Central	8		
04.AC.083	Kit H.Central M.Inf. Oculto Tapas Aluminio		8	
04.AC.084	Kit H.Central M.Inf. Oculto Piso Corrido			8
04.AC.070	Tapa H.Lateral M.Inf. Oculto Tapas Aluminio		4	
04.AC.071	Tapa H.Lateral M.Inf. Oculto Piso Corrido			4
04.AC.079	Kit Cortavientos	4		
04.AC.080	Kit Cortavientos Marco Inferior Oculto		4	4
04.AC.076	Tape Inf. 4 Hojas Marco Infe. Oculto		1	1
04.AC.085	Taco Estanq. M.Inf. Oculto Tapas Aluminio		2	
04.AC.086	Taco Estanq. M.Inf. Oculto Piso Corrido			2
04.AC.087	Cortavientos Hoja movil	4	4	4
04.TO.026	Tocho unión Marco	12	12	12
04.AC.F10	Felpudo Marco Sup/Inf	3,5L	1,5L	1,5L
04.AC.F09	Felpudo Suplementos Hoja 16.349 y 16.651		1,5L	1,5L
04.JU.004.D	Junta Cierre Lateral	4H	4H	4H
04.JU.004.E	Junta Cierre 4 Hojas	2H	2H	2H
04.JU.062	Junta Cruce Central	8H	8H	8H
04.JU.067	Junta Cruce Central	8H	8H	8H
04.JU.068	Junta Tapa canal Marco	2L	2L	2L
04.JU.069	Junta Carril	4L	4L	4L
04.AC.R150	Carril Acero Inox.	4L	4L	4L
04.AC.R152	Rodamiento	8	8	8
04.AC.R153	Kit Angulo Rod. M.Inf. Oculto Tapas Aluminio		4	
04.AC.R154	Kit Angulo Rod. M.Inf. Oculto Piso Corrido			4
04.AC.074	Calzo Hoja Fija	4	4	4
04.JA.004	Junta Hoja Fija	L+4H	L+4H	L+4H
04.TA.070	Tapa para Canaleta	2	2	2
04.TA.071	Tapa para Solera	2	2	2
04.AC.073	Calzo Vidrio	Según dimensiones de Vidrio		

*Se indica la longitud total necesaria. Las tapas se colocan en tramos para permitir el montaje.

En caso de piso corrido las tapas que ocultan el marco inferior deben de ser registrables para permitir sacar las hojas en caso de necesidad.

BALCONERA 6 HOJAS

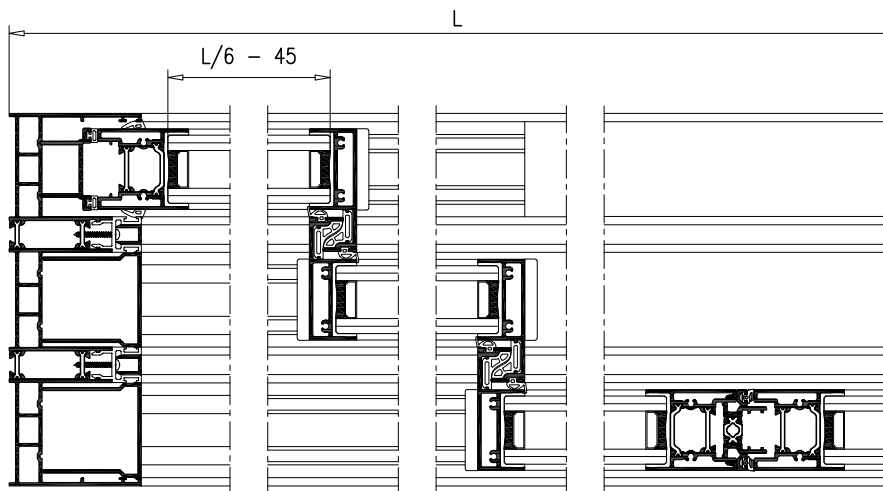
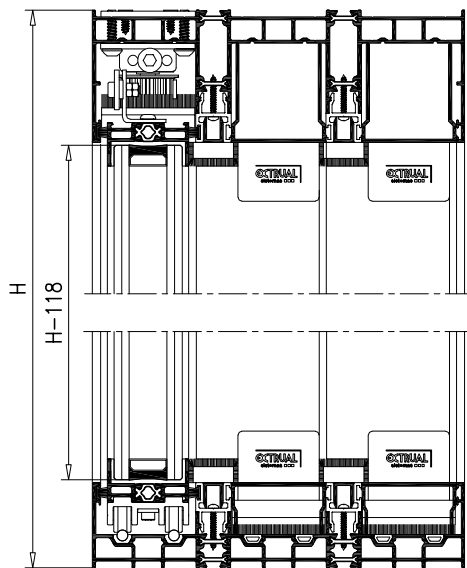

BALCONERA 6 HOJAS
Marco Inferior Oculto Tapas de Aluminio

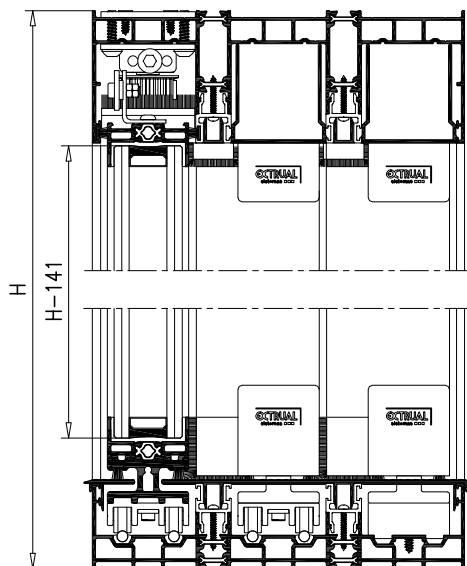

BALCONERA 6 HOJAS
Marco Inferior Oculto Piso Corrido

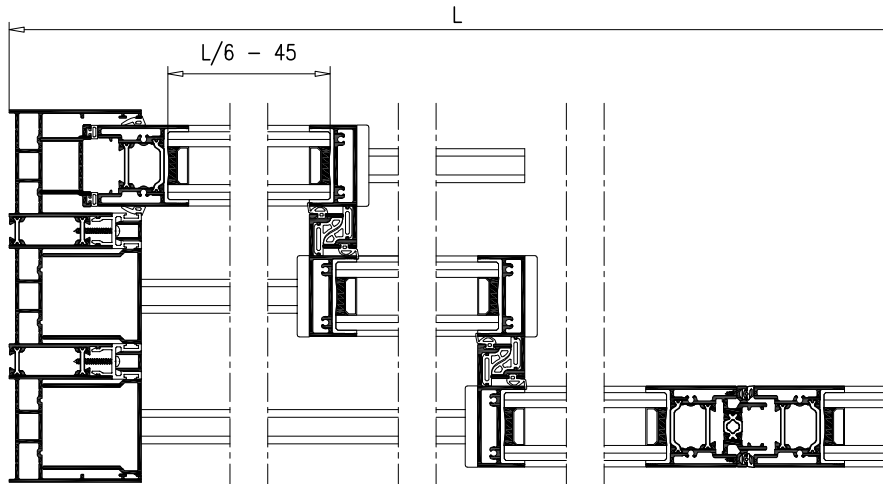
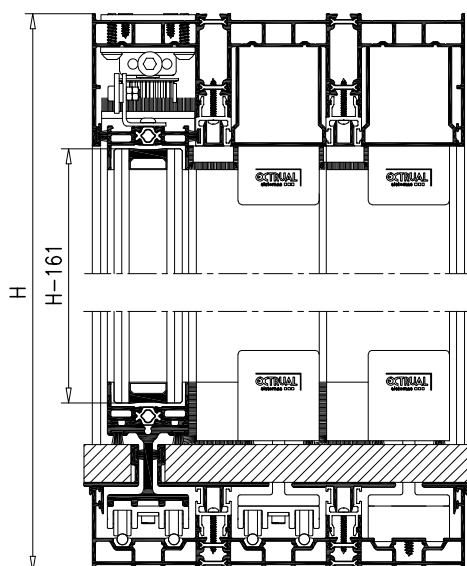

BALCONERA 6 HOJAS

PERFILES

REFERENCIA	DENOMINACION	MARCO INFERIOR VISTO		MARCO INFERIOR OCULTO TAPAS ALUMINIO		MARCO INFERIOR OCULTO PISO CORRIDO	
		CANTI.	CORTE	CANTI.	CORTE	CANTI.	CORTE
R-955	MARCO LAT/SUP +38.PP.020 (x2)	2	H	2	H	2	H
		1	L-140	1	L-140	1	L-140
R-942	MARCO INFERIOR +38.PP.020 (x2)	1	L-140	1	L-140	1	L-140
R-943	HOJA LATERAL	4	H-140	4	H-163	4	H-183
R-945	HOJA SUP/INF	8	(L/6)-5	8	(L/6)-5	8	(L/6)-5
		4	(L/6)-17	4	(L/6)-17	4	(L/6)-17
16.349	SUPLEMENT. HOJA			4	(L/6)-5		
				2	(L/6)-17		
16.651	SUPLEMENT. HOJA					4	(L/6)-5
						2	(L/6)-17
16.347	HOJA DE CIERRE	8	H-140	8	H-163	8	H-183
16.857	CIERRE LATERAL	2	H-75	1	H-114	1	H-134
R-946	CIERRE 4 HOJAS	1	H-94	1	H-119	1	H-139
16.342	TAPA CANAL	4	H-96	4	H-96	4	H-96
		4	(L/6)-41	2	(L/6)-41	2	(L/6)-41
		4	(L/3)-82	2	(L/3)-82	2	(L/3)-82
		2	(4L/6)-109	1	(4L/6)-109	1	(4L/6)-109
		2	(L/3)-27	1	(L/3)-27	1	(L/3)-27
		2		1		1	
16.858	TAPA MARCO LAT/SUP	4	H-75	4	H-75	4	H-75
		2	(L/3)-27	1	(L/3)-27	1	(L/3)-27
16.343	TAPA MARCO INFERIOR	2	(L/3)-27				
16.344*	TAPA CENTRAL			4	(L/3)-53		
16.345*	TAPA LATERAL			2	(L/3)-53		
				1	L-140		
16.346*	TAPA DOBLE					1	(L/3)-35
16.608*	TAPA TRIPLE			1	(L/3)-35		
16.652*	TAPA CENTRAL					4	(L/3)-53
16.653*	TAPA LATERAL					2	(L/3)-53
				1	L-140		
16.654*	TAPA MULTIPLE					1	(L/3)-35
R-949	SOLERA	1	L-4	1	L-4	1	L-4
15.686	TAPA CANALETA	1	L-144	1	L-144		
16.351	CANALETA DRENAJE	1	L-194	1	L-144	1	L-144

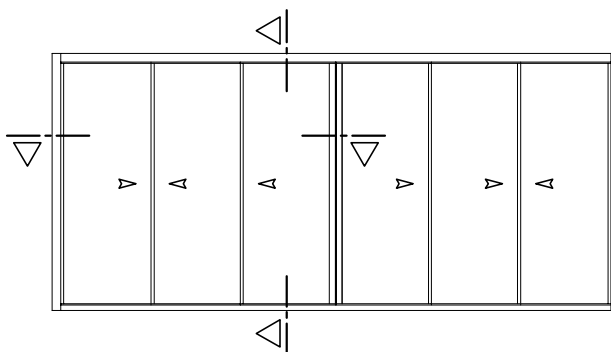

Aperturas independientes (4 pulsadores)

ACCESORIOS

REFERENCIA	DENOMINACION	M.INF. VISTO	M.INF. OCULTO TAPAS ALUMINIO	M.INF. OCULTO PISO CORRIDO
		UNIDADES	UNIDADES	UNIDADES
04.MOT.006	Kit Motor	6	6	6
04.MOT.009	Correa 14mts	2 ó 6	2 ó 6	2 ó 6
04.MOT.010	Correa 30mts			
04.MOT.011	Conector Hoja	6	6	6
04.MOT.012	Eletrrocerradura	2	2	2
04.MOT.013	Eletrrocerradura	2	2	2
04.MOT.014	Transformador 100W	2	2	2
04.MOT.015	Transformador 200W	2	2	2
04.MOT.016	Botonera	4	4	4
04.MOT.017	Gateway	4	4	4
04.AC.067	Kit Hoja Lateral	4	4	4
04.AC.082	Kit Hoja Central	8		
04.AC.083	Kit H.Central M.Inf. Oculto Tapas Aluminio		8	
04.AC.084	Kit H.Central M.Inf. Oculto Piso Corrido			8
04.AC.070	Tapa H.Lateral M.Inf. Oculto Tapas Aluminio		4	
04.AC.079	Tapa H.Lateral M.Inf. Oculto Piso Corrido			4
04.AC.071	Kit Cortavientos	4		
04.AC.080	Kit Cortavientos Marco Inferior Oculto		4	4
04.AC.076	Tapo Inf. 4 Hojas Marco Infe. Oculto		1	1
04.AC.085	Taco Estanq. M.Inf. Oculto Tapas Aluminio		2	
04.AC.086	Taco Estanq. M.Inf. Oculto Piso Corrido			2
04.AC.087	Cortavientos Hoja movil	4	4	4
04.TO.026	Tocho unión Marco	12	12	12
04.AC.F10	Felpudo Marco Sup/Inf	4L	2L	2L
04.AC.F12	Felpudo Marco Lateral	4H	4H	4H
04.AC.F09	Felpudo Suplementos Hoja 16.349 y 16.651		2L	2L
04.JU.004.D	Junta Cierre Lateral	4H	4H	4H
04.JU.004.E	Junta Cierre 4 Hojas	2H	2H	2H
04.JU.062	Junta Cruce Central	8H	8H	8H
04.JU.067	Junta Cruce Central	8H	8H	8H
04.JU.068	Junta Tapa canal Marco	2L	2L	2L
04.JU.069	Junta Carril	4L	4L	4L
04.AC.R150	Carril Acero Inox.	5L	5L	5L
04.AC.R152	Rodamiento	12	12	12
04.AC.R153	Kit Angulo Rod. M.Inf. Oculto Tapas Aluminio		6	
04.AC.R154	Kit Angulo Rod. M.Inf. Oculto Piso Corrido			6
04.TA.070	Tapa para Canaleta	2	2	2
04.TA.071	Tapa para Solera	2	2	2
04.AC.073	Calzo Vidrio	Según dimensiones de Vidrio		

*Se indica la longitud total necesaria. Las tapas se colocan en tramos para permitir el montaje.

En caso de piso corrido las tapas que ocultan el marco inferior deben de ser registrables para permitir sacar las hojas en caso de necesidad.

BALCONERA 3 HOJAS+FIJO Marco 4 Carriles

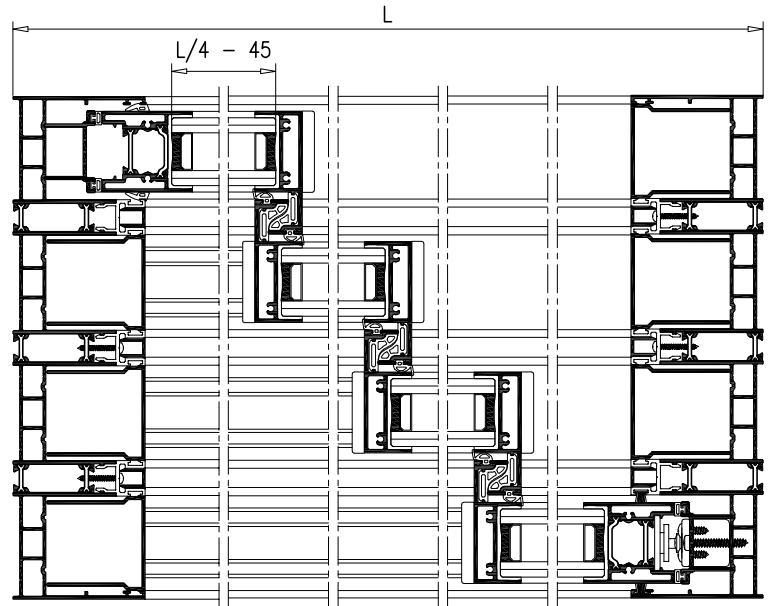
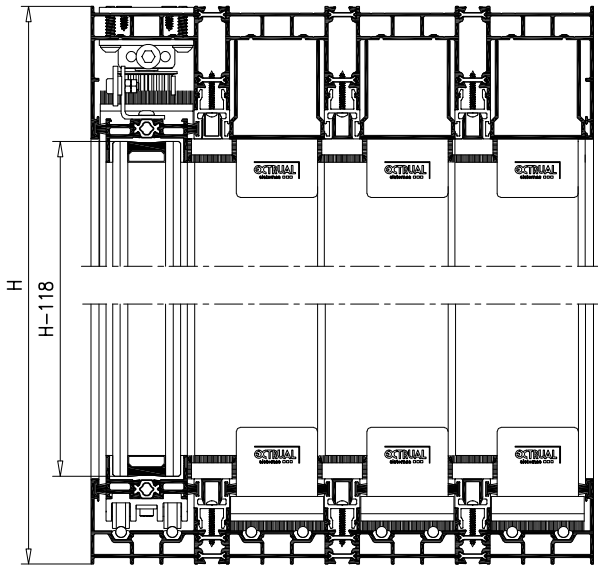

BALCONERA 3 HOJAS+FIJO Marco 4 Carriles Marco Inferior Oculto Tapas de Aluminio

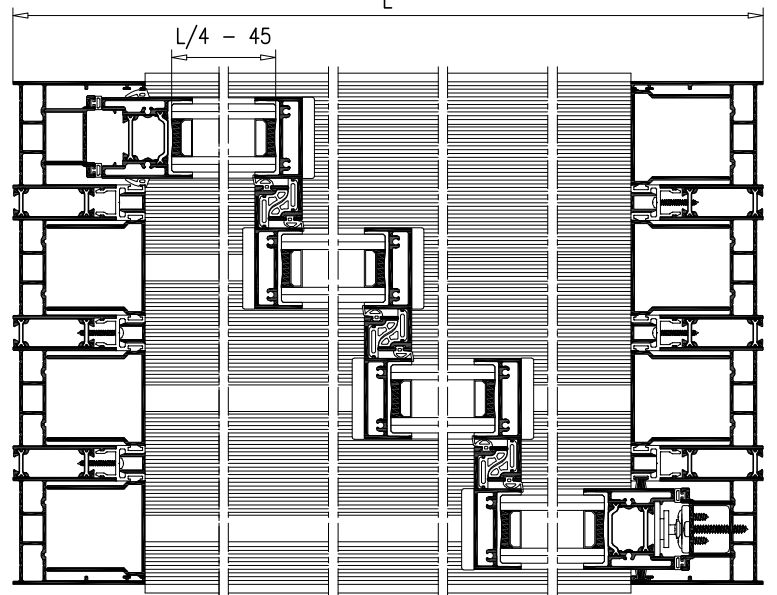
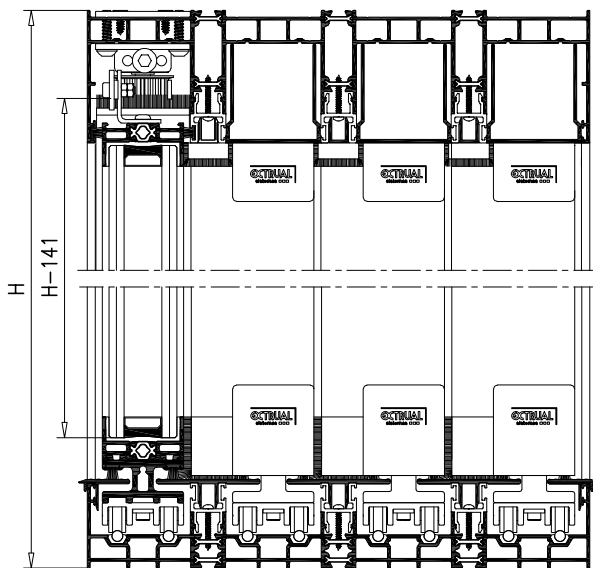

BALCONERA 3 HOJAS+FIJO Marco 4 Carriles Marco Inferior Oculto Piso Corrido

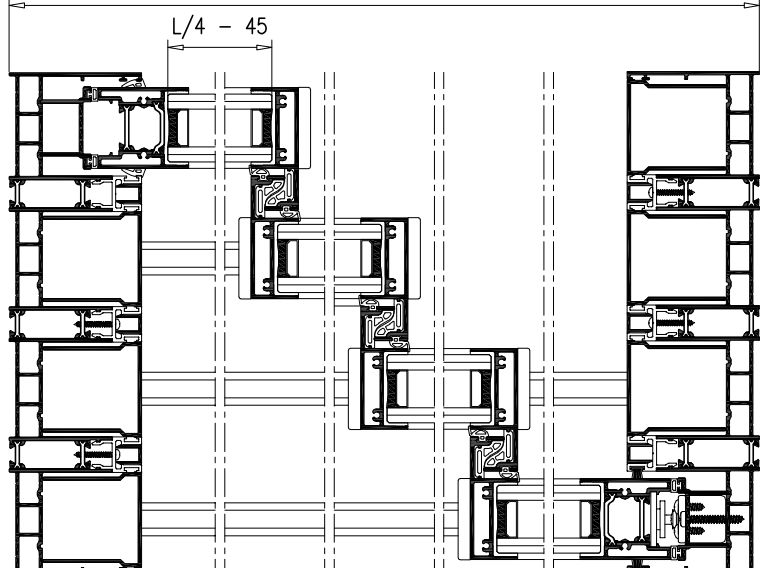
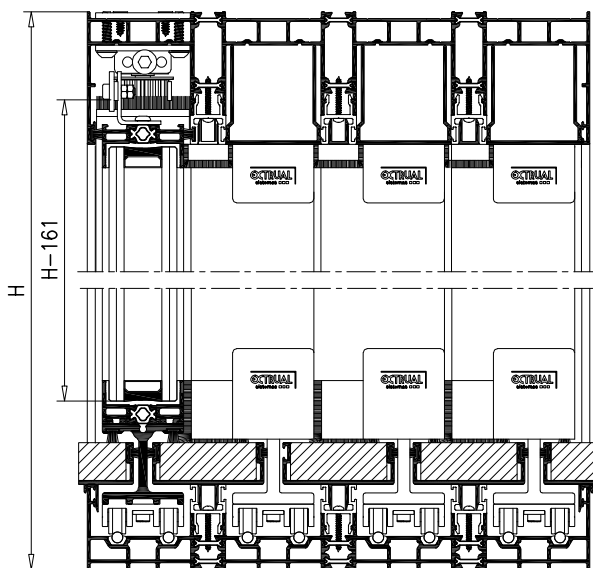

BALCONERA 3 HOJAS+FIJO Marco 4 Carriles

PERFILES

REFERENCIA	DENOMINACION	MARCO INFERIOR VISTO		MARCO INFERIOR OCULTO TAPAS ALUMINIO		MARCO INFERIOR OCULTO PISO CORRIDO	
		CANT.	CORTE	CANT.	CORTE	CANT.	CORTE
R-956	MARCO LAT/SUP +38.PP.020 (x3)	2	H	2	H	2	H
		1	L-140	1	L-140	1	L-140
R-952	MARCO INFERIOR +38.PP.020 (x3)	1	L-140	1	L-140	1	L-140
R-943	HOJA LATERAL	2	H-140	2	H-163	2	H-183
R-945	HOJA SUP/INF	4	(L/4)-5	4	(L/4)-5	4	(L/4)-5
		4	(L/4)-17	4	(L/4)-17	4	(L/4)-17
16.349	SUPLEMENT. HOJA			2	(L/4)-5		
				2	(L/4)-17		
16.651	SUPLEMENT. HOJA					2	(L/4)-5
						2	(L/4)-17
16.347	HOJA DE CIERRE	6	H-140	6	H-163	6	H-183
16.857	CIERRE LATERAL	2	H-75	1	H-114	1	H-134
16.342	TAPA CANAL	6	H-96	6	H-96		H-96
		4	(L/4)-41	2	(L/4)-41		(L/4)-41
		4	(L/2)-83	2	(L/2)-83		(L/2)-83
		4	(3L/4)-124	2	(3L/4)-124		(3L/4)-124
16.858	TAPA MARCO	6	H-75	6	H-75	6	H-75
		2	(L/4)-41	1	(L/4)-41	1	(L/4)-41
		2	(L/2)-83	1	(L/2)-83	1	(L/2)-83
		2	(3L/4)-124	1	(3L/4)-124	1	(3L/4)-124
16.343	TAPA MARCO INFERIOR	1	(L/4)-41				
		1	(L/2)-83				
		1	(3L/4)-124				
16.344*	TAPA CENTRAL				7L/4		
16.345*	TAPA LATERAL				5L/4		L/4
16.346*	TAPA DOBLE				L/4		L/4
16.608*	TAPA TRIPLE				L/2		L/4
16.652*	TAPA CENTRAL						3L/2
16.653*	TAPA LATERAL						5L/4
16.654*	TAPA MULTIPLE						3L/4
R-953	SOLERA	1	L-4	1	L-4	1	L-4
15.686	TAPA CANALETA	1	L-144	1	L-144		
16.351	CANALETA DRENAJE	1	L-144	1	L-144	1	L-144

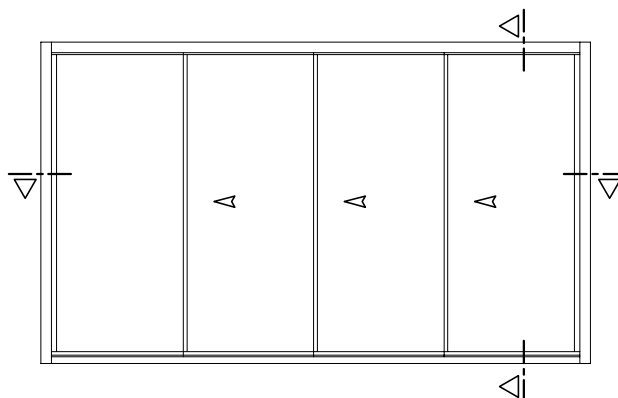

ACCESORIOS

REFERENCIA	DENOMINACION	M.INF. VISTO	M.INF. OCULTO TAPAS ALUMINIO	M.INF. OCULTO PISO CORRIDO
		UNIDADES	UNIDADES	UNIDADES
04.MOT.006	Kit Motor	3	3	3
04.MOT.009	Correa 14mts			
04.MOT.010	Correa 30mts	3	3	3
04.MOT.011	Conector Hoja	3	3	3
04.MOT.012	Electrocerradura	1	1	1
04.MOT.014	Transformador	1	1	1
04.MOT.015	Transformador	1	1	1
04.MOT.016	Botonera	1	1	1
04.MOT.017	Gateway	1	1	1
04.AC.067	Kit Hoja Lateral	2	2	2
04.AC.082	Kit Hoja Central	6		
04.AC.083	Kit H.Central M.Inf. Oculto Tapas Aluminio		6	
04.AC.084	Kit H.Central M.Inf. Oculto Piso Corrido			6
04.AC.070	Tapa H.Lateral M.Inf. Oculto Tapas Aluminio		2	
04.AC.079	Tapa H.Lateral M.Inf. Oculto Piso Corrido			2
04.AC.071	Kit Cortavientos	3		
04.AC.080	Kit Cortavientos Marco Inferior Oculto		3	3
04.AC.085	Taco Estanq. M.Inf. Oculto Tapas Aluminio		2	
04.AC.086	Taco Estanq. M.Inf. Oculto Piso Corrido			2
04.TO.026	Tocho unión Marco	16	16	16
04.AC.F10	Felpudo Marco Sup/Inf	4L	2L	8L
04.AC.F12	Felpudo Marco Lateral	2H	2H	2H
04.AC.F09	Felpudo Suplementos Hoja 16.349 y 16.651		2L	4L
04.JU.004.D	Junta Cierre Lateral	4H	4H	4H
04.JU.062	Junta Cruce Central	6H	6H	6H
04.JU.067	Junta Cruce Central	6H	6H	6H
04.JU.068	Junta Tapacanal Marco	6L	6L	6L
04.JU.069	Junta Carril	6L	6L	6L
04.AC.R150	Carril Acero Inox.	6L	6L	6L
04.AC.R152	Rodamiento	8	8	8
04.AC.R153	Kit Angulo Rod. M.Inf. Oculto Tapas Aluminio		4	
04.AC.R154	Kit Angulo Rod. M.Inf. Oculto Piso Corrido			4
04.AC.074	Calzo Hoja Fija	2	2	2
04.JA.004	Junta Hoja Fija	2H+L/2	2H+L/4	4H+L/4
04.TA.070	Tapa para Canaleta	2	2	2
04.TA.075	Tapa para Solera	2	2	2
04.AC.073	Calzo Vidrio	Según dimensiones de Vidrio		

*Se indica la longitud aproximada necesaria. Las tapas se colocan en tramos para permitir el montaje.
En caso de piso corrido las tapas que ocultan el marco inferior deben de ser registrables para permitir sacar las hojas en caso de necesidad.

BALCONERA 6 HOJAS + 2 FIJOS Marco 4 Carriles

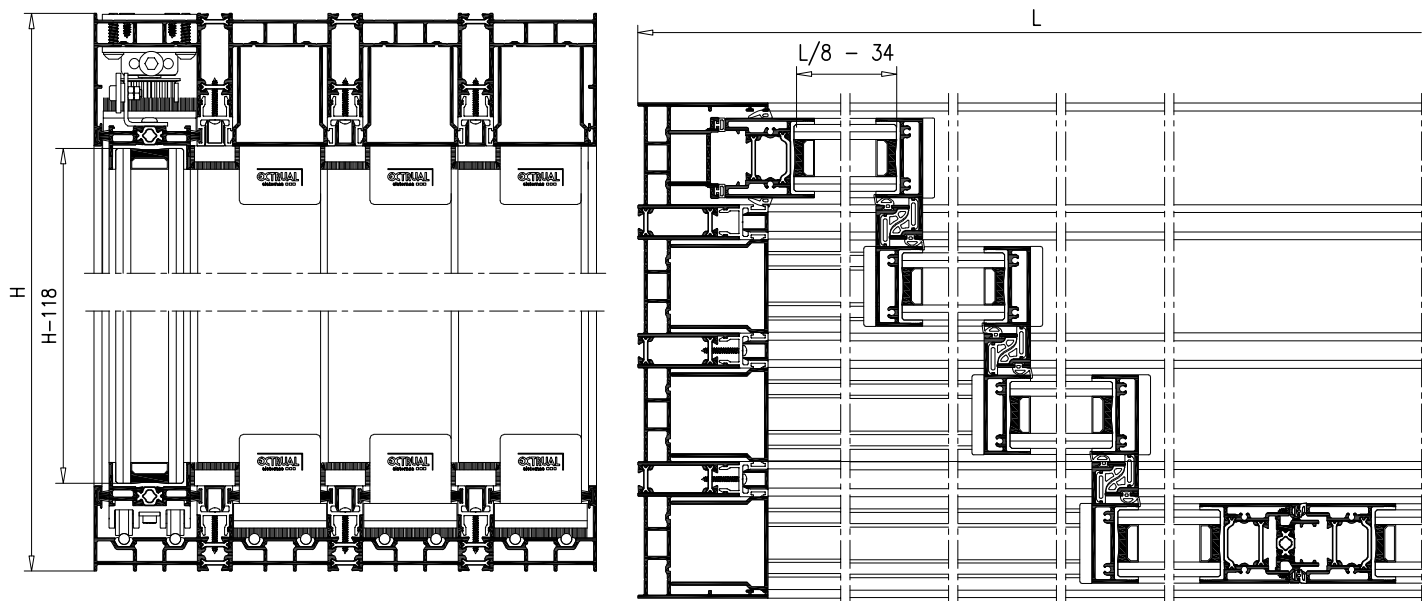

BALCONERA 6 HOJAS + 2 FIJOS Marco 4 Carriles Marco Inferior Oculto Tapas de Aluminio

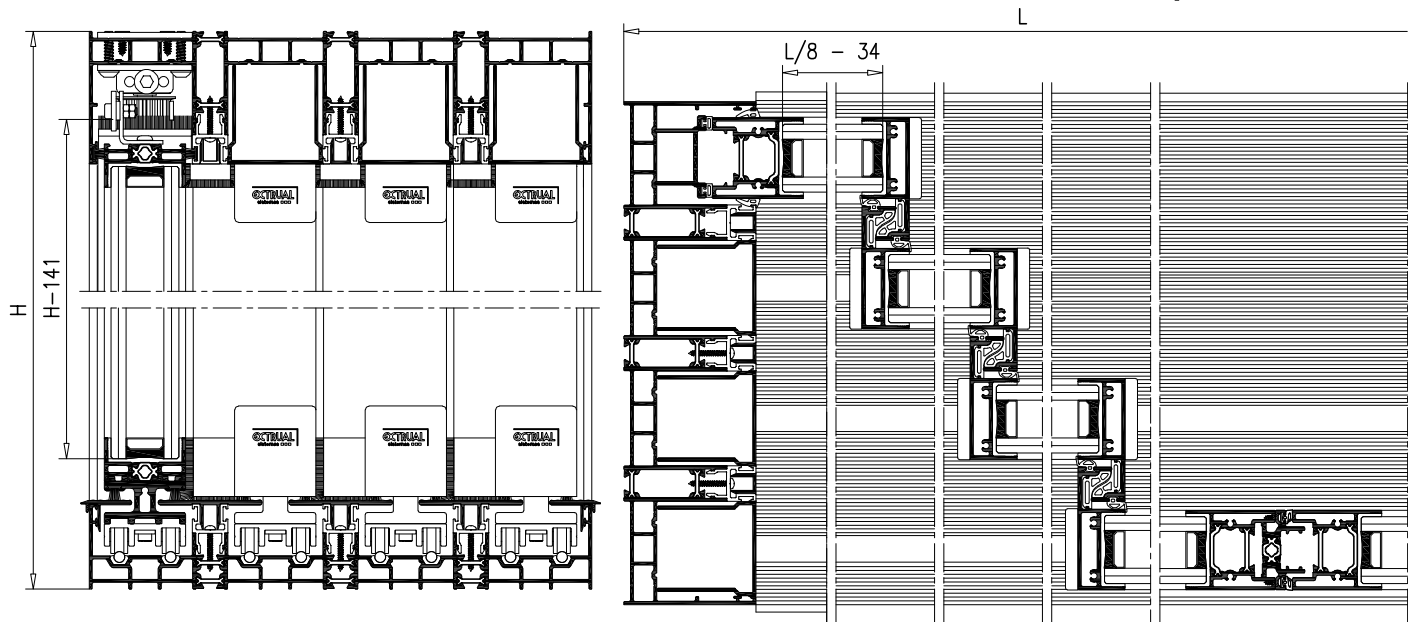

BALCONERA 6 HOJAS + 2 FIJOS Marco 4 Carriles Marco Inferior Oculto Piso Corrido

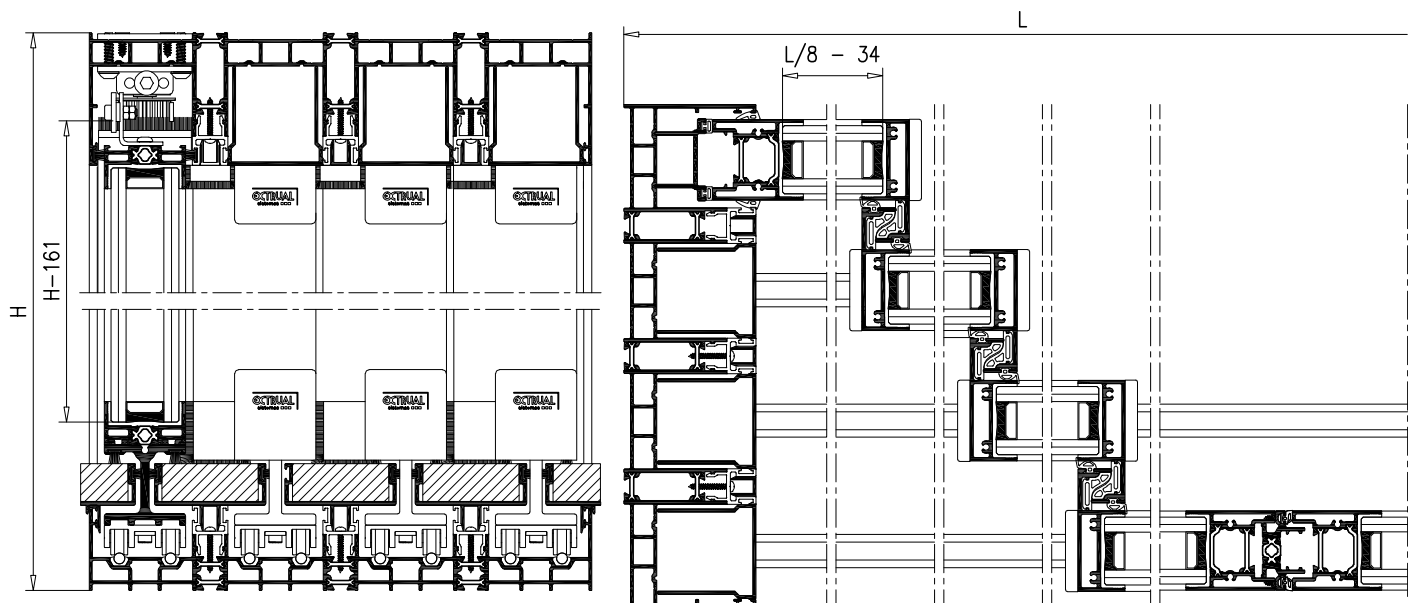

PERFILES

REFERENCIA	DENOMINACION	MARCO INFERIOR VISTO		MARCO INFERIOR OCULTO TAPAS ALUMINIO		MARCO INFERIOR OCULTO PISO CORRIDO	
		CANT.	CORTE	CANT.	CORTE	CANT.	CORTE
R-956	MARCO LAT/SUP +38.PP.020 (x3)	2	H	2	H	2	H
R-952	MARCO INFERIOR +38.PP.020 (x3)	1	L-140	1	L-140	1	L-140
R-943	HOJA LATERAL	4	H-140	4	H-163	4	H-183
R-945	HOJA SUP/INF	8	(L/8)+6 (L/8)-6	8	(L/8)+6 (L/8)-6	8	(L/8)+6 (L/8)-6
16.349	SUPLEMENT. HOJA			8	(L/8)+6 (L/8)-6		
16.651	SUPLEMENT. HOJA					8	(L/8)+6 (L/8)-6
16.347	HOJA DE CIERRE	12	H-140	12	163	12	H-183
16.857	CIERRE LATERAL	2	H-75	1	H-114	1	H-134
16.857	CIERRE 4 HOJAS	1	H-94		H-119		H-139
16.342	TAPA CANAL	6	H-96 (L/8)-29 (L/4)-60 (3L/8)-90 (L/4)-7 (L/2)-68 (6L/4)-129	6	H-96 (L/8)-29 (L/4)-60 (3L/8)-90 (L/4)-7 (L/2)-68 (6L/4)-129	6	H-96 (L/8)-29 (L/4)-60 (3L/8)-90 (L/4)-7 (L/2)-68 (6L/4)-129
16.858	TAPA MARCO	6	H-75 (L/4)-7 (L/2)-68 (6L/4)-129	6	H-75 (L/4)-7 (L/2)-68 (6L/4)-129	6	H-75 (L/4)-7 (L/2)-68 (6L/4)-129
16.343	TAPA MARCO INFERIOR	1	(L/4)-7 (L/2)-68 (6L/4)-129				
16.344*	TAPA CENTRAL				14L/8		
16.345*	TAPA LATERAL				10L/8	L/4	
16.346*	TAPA DOBLE				L/4	L/4	
16.608*	TAPA TRIPLE				L/2	L/4	
16.652*	TAPA CENTRAL					12L/8	
16.653*	TAPA LATERAL					10L/8	
16.654*	TAPA MULTIPLE					6L/8	
R-953	SOLERA	1	L-4	1	L-4	1	L-4
15.686	TAPA CANALETA	1	L-144	1	L-144		
16.351	CANALETA DRENAJE	1	L-144	1	L-144	1	L-144

BALCONERA 6 HOJAS + 2 FIJOS
Marco 4 Carriles

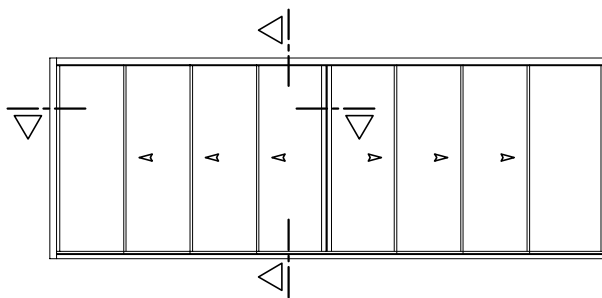

Aperturas independientes (2 pulsadores)

ACCESORIOS

REFERENCIA	DENOMINACION	M.INF. VISTO	M.INF. OCULTO TAPAS ALUMINIO	M.INF. OCULTO PISO CORRIDO
		UNIDADES	UNIDADES	UNIDADES
04.MOT.006	Kit Motor	6	6	6
04.MOT.009	Correa 14mts	6	6	6
04.MOT.010	Correa 30mts			
04.MOT.011	Conector Hoja	6	6	6
04.MOT.013	Eletrrocerradura	2	2	2
04.MOT.015	Transformador	2	2	2
04.MOT.016	Botonera	2	2	2
04.MOT.017	Gateway	2	2	2
04.AC.067	Kit Hoja Lateral	4	4	4
04.AC.082	Kit Hoja Central	12		
04.AC.083	Kit H.Central M.Inf. Oculto Tapas Aluminio		12	
04.AC.084	Kit H.Central M.Inf. Oculto Piso Corrido			12
04.AC.070	Tapa H.Lateral M.Inf. Oculto Tapas Aluminio		4	
04.AC.079	Tapa H.Lateral M.Inf. Oculto Piso Corrido			4
04.AC.071	Kit Cortavientos	6		
04.AC.080	Kit Cortavientos Marco Inferior Oculto		6	6
04.AC.076	Tape Inf. 4 Hojas Marco Inf. Oculto	1	1	1
04.AC.085	Taco Estanq. M.Inf. Oculto Tapas Aluminio		2	
04.AC.086	Taco Estanq. M.Inf. Oculto Piso Corrido			2
04.AC.087	Cortavientos Hoja Móvil	12	12	12
04.TO.026	Tocho unión Marco	16	16	16
04.AC.F10	Felpudo Marco Sup/Inf	4L	2L	2L
04.AC.F12	Felpudo Marco Lateral	2H	2H	2H
04.AC.F09	Felpudo Suplementos Hoja 16.349 y 16.651		7L	7L
04.JU.004.D	Junta Cierre Lateral	4H	4H	4H
04.JU.004.E	Junta Cierre 4 Hojas	2H	2H	2H
04.JU.062	Junta Cruce Central	12H	12H	12H
04.JU.067	Junta Cruce Central	12H	12H	12H
04.JU.068	Junta Tapa Canal Marco	4L	4L	4L
04.JU.069	Junta Carril	4L	4L	4L
04.AC.R150	Carril Acero Inox.	4L	4L	4L
04.AC.R152	Rodamiento	12	12	12
04.AC.R153	Kit Angulo Rod. M.Inf. Oculto Tapas Aluminio		6	
04.AC.R154	Kit Angulo Rod. M.Inf. Oculto Piso Corrido			6
04.AC.074	Calzo Hoja Fija	4	4	4
04.JA.004	Junta Hoja Fija	4H+L	4H+L	4H+L
04.TA.070	Tapa para Canaleta	2	2	2
04.TA.075	Tapa para Solera	2	2	2
04.AC.073	Calzo Vidrio	Según dimensiones de Vidrio		

* Se indica la longitud aproximada necesaria. Las tapas se colocan en tramos para permitir el montaje.

En caso de piso corrido las tapas que ocultan el marco inferior deben de ser registrables para permitir sacar las hojas en caso de necesidad.

BALCONERA 1 HOJA ENTREMUROS

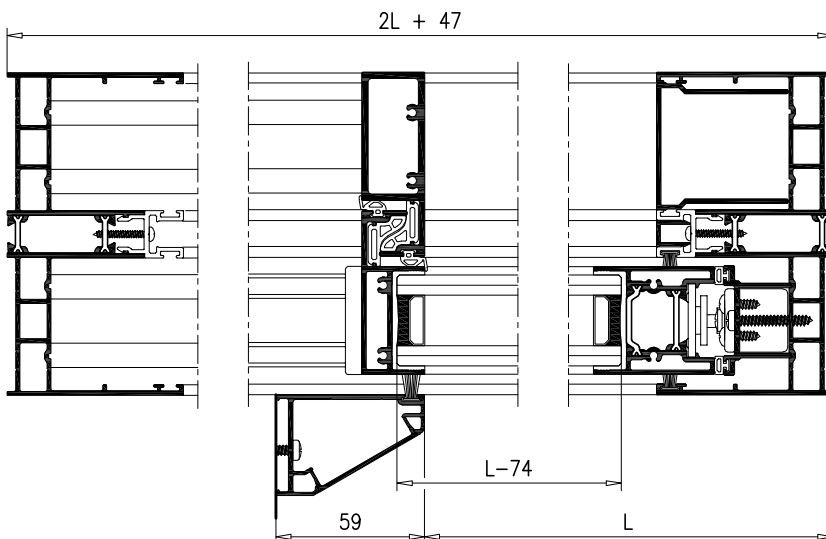
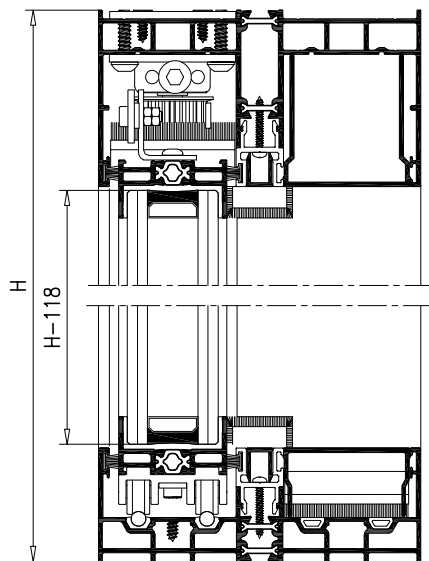

BALCONERA 1 HOJA ENTREMUROS
Marco Inferior Oculto Tapas de Aluminio

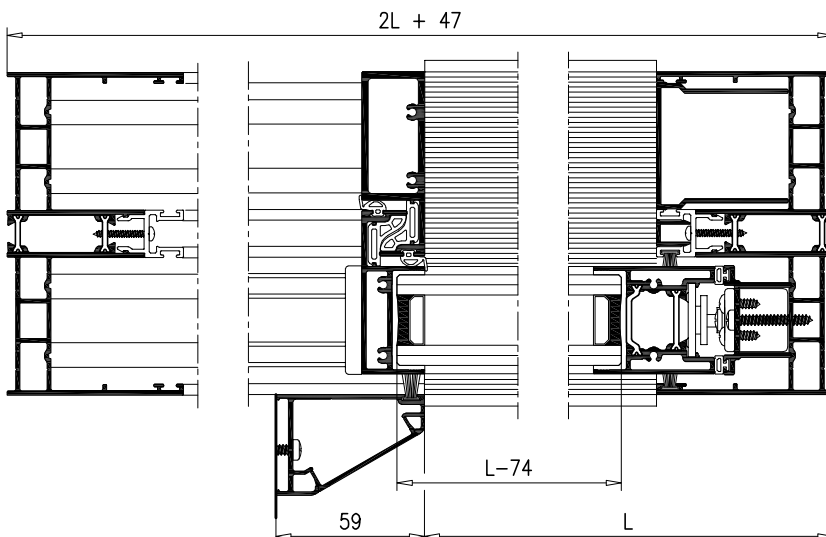
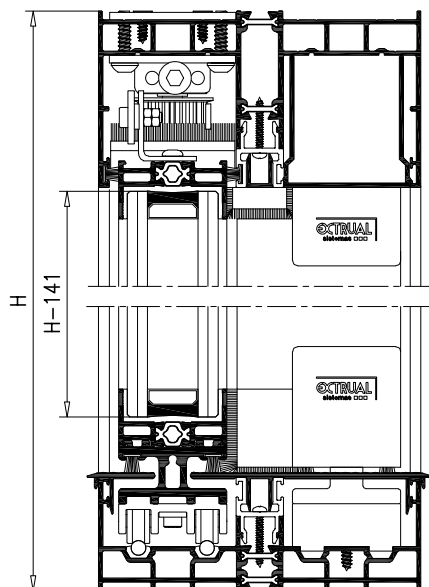

BALCONERA 1 HOJA ENTREMUROS
Marco Inferior Oculto Piso Corrido

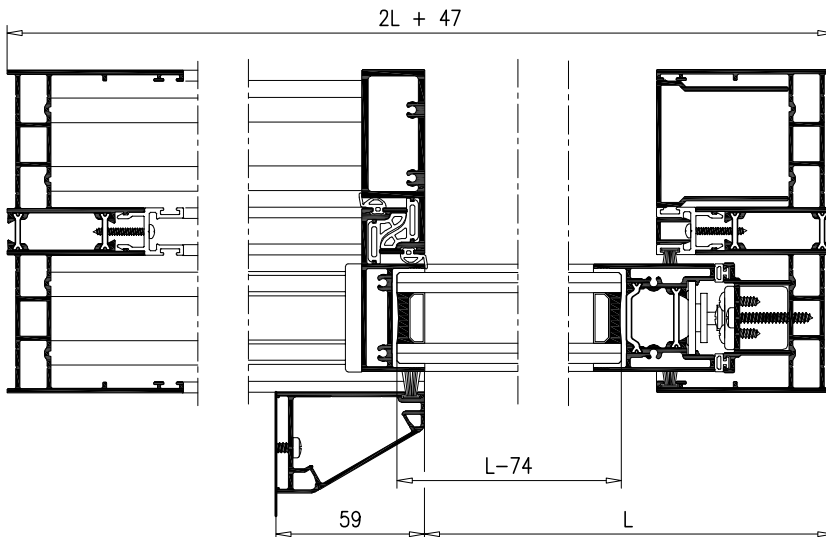
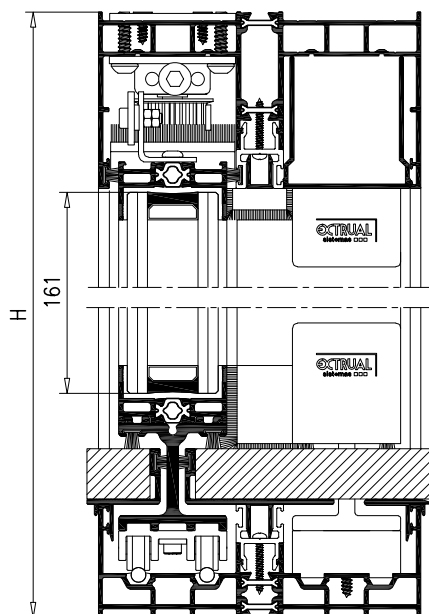

BALCONERA 1 HOJA ENTREMUROS

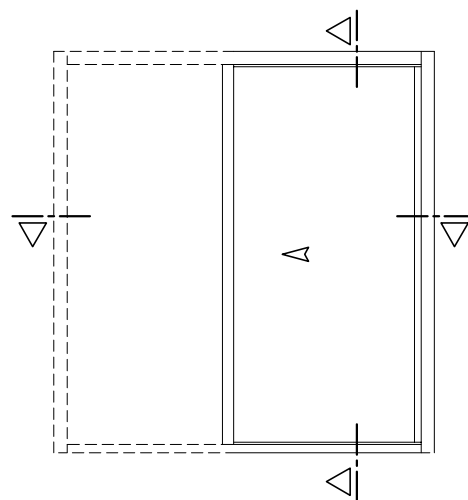

ES NECESARIO HACER REGISTRO PARA ACCEDER A LA ZONA DE LA POLEA DE RETORNO Y DEL CONECTOR DE HOJA

PERFILES

REFERENCIA	DENOMINACION	MARCO INFERIOR VISTO		MARCO INFERIOR OCULTO TAPAS ALUMINIO		MARCO INFERIOR OCULTO PISO CORRIDO	
		CANT.	CORTE	CANT.	CORTE	CANT.	CORTE
R-954	MARCO LAT/SUP +38.PP.020	2	H	2	H	2	H
		1	2L-93	1	2L-93	1	2L-93
R-941	MARCO INFERIOR +38.PP.020	1	2L-93	1	2L-93	1	2L-93
16.350	PERFIL DE CIERRE	1	H-60	1	H-60	1	H-60
R-943	HOJA LATERAL	1	H-140	1	H-163	1	H-183
R-945	HOJA SUP/INF	2	L-34	2	L-34	2	L-34
16.349	SUPLEMENT. HOJA			1	L-34		
16.651	SUPLEMENT. HOJA					1	L-34
16.347	HOJA DE CIERRE	1	H-140	1	H-163	1	H-183
16.857	CIERRE LATERAL	1	H-75	1	H-114	1	H-134
16.342	TAPA CANAL	1	H-96	1	H-96	1	H-96
		2	L-70	2	L-70	2	L-70
16.858	TAPA MARCO LAT/SUP	1	H-36	1	H-36	1	H-36
		1	L-70	1	L-70	1	L-70
16.343	TAPA MARCO INFERIOR	1	L-70				
13.248	CIERRE ENTREMUROS	1	H-115	1	H-115	1	H-137
7.438	TAPETA PARA 13.248	1	H-115	1	H-115	1	H-137
16.345*	TAPA LATERAL			1	L-70	1	L-70
16.346*	TAPA DOBLE			1	L-70		
16.653*	TAPA LATERAL					1	L-70
16.654*	TAPA MULTIPLE					1	L-70
R-948	SOLERA	1	2L-97	1	2L-97	1	2L-97
15.686	TAPA CANALETA	1	L-74	1	L-74		
16.351	CANALETA DRENAJE	1	L-74	1	L-74	1	L-74

ACCESORIOS

REFERENCIA	DENOMINACION	M.INF. VISTO	M.INF. OCULTO TAPAS ALUMINIO	M.INF. OCULTO PISO CORRIDO
		UNIDADES	UNIDADES	UNIDADES
04.MOT.006	Kit Motor	1	1	1
04.MOT.009	Correa 14mts	1	1	1
04.MOT.010	Correa 30mts			
04.MOT.011	Conector Hoja	1	1	1
04.MOT.012	Eletrocerradura	1	1	1
04.MOT.014	Transformador	1	1	1
04.MOT.016	Botonera	1	1	1
04.MOT.017	Gateway	1	1	1
04.AC.067	Kit Hoja Lateral	1	1	1
04.AC.082	Kit Hoja Central	1		
04.AC.083	Kit H.Central M.Inf. Oculto Tapas Aluminio		1	
04.AC.084	Kit H.Central M.Inf. Oculto Piso Corrido			1
04.AC.070	Tapa H.Lateral M.Inf. Oculto Tapas Aluminio		1	
04.AC.079	Tapa H.Lateral M.Inf. Oculto Piso Corrido			1
04.AC.071	Kit Cortavientos	1	1	1
04.AC.085	Taco Estanq. M.Inf. Oculto Tapas Aluminio		1	
04.AC.086	Taco Estanq. M.Inf. Oculto Piso Corrido			1
04.TO.026	Tocho unión Marco	8	8	8
04.AC.F10	Felpudo Marco Sup/Inf	4L	2L	4L
04.AC.F11	Felpudo Cierre Entremuros	H	H	H
04.AC.F12	Felpudo Marco Lateral	2H	2H	2H
04.AC.F09	Felpudo Suplementos Hoja 16.349 y 16.651		2L	2L
04.JU.004.D	Junta Cierre Lateral	2H	2H	2H
04.JU.062	Junta Cruce Central	2H	2H	2H
04.JU.067	Junta Cruce Central	2H	2H	2H
04.JU.068	Junta Tapacanal Marco	2L	2L	2L
04.JU.069	Junta Carril	x2	2L-200	2L-200
04.AC.R150	Carril Acero Inox.	x2	2L-200	2L-200
04.AC.R152	Rodamiento	2	2	2
04.AC.R153	Kit Angulo Rod. M.Inf. Oculto Tapas Aluminio		1	
04.AC.R154	Kit Angulo Rod. M.Inf. Oculto Piso Corrido			1
04.TA.070	Tapa para Canaleta	2	2	2
04.TA.071	Tapa para Solera	2	2	2
04.AC.073	Calzo Vidrio	Según dimensiones de Vidrio		

*Se indica la longitud total necesaria. Las tapas se colocan en tramos para permitir el montaje.

En caso de piso corrido las tapas que ocultan el marco inferior deben de ser registrables para permitir sacar las hojas en caso de necesidad.

BALCONERA 1+1 HOJAS ENTREMUROS

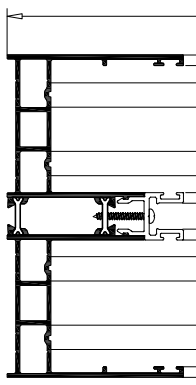
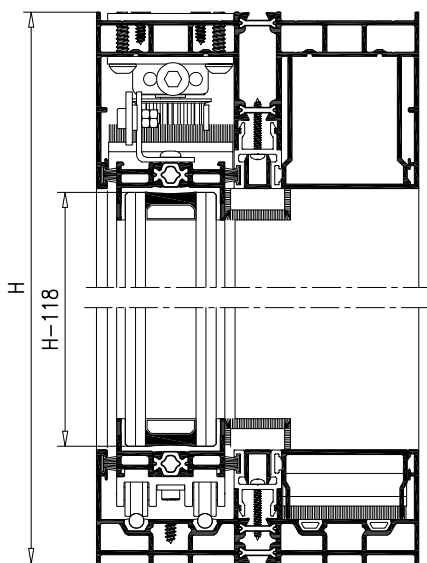

2L + 181

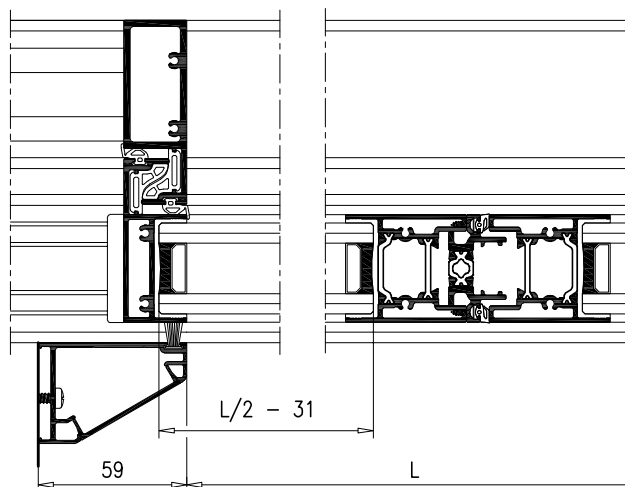

BALCONERA 1+1 HOJAS ENTREMUROS
Marco Inferior Oculto Tapas de Aluminio

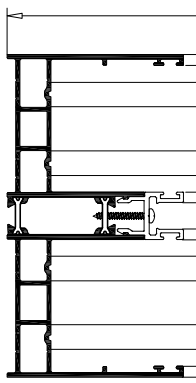
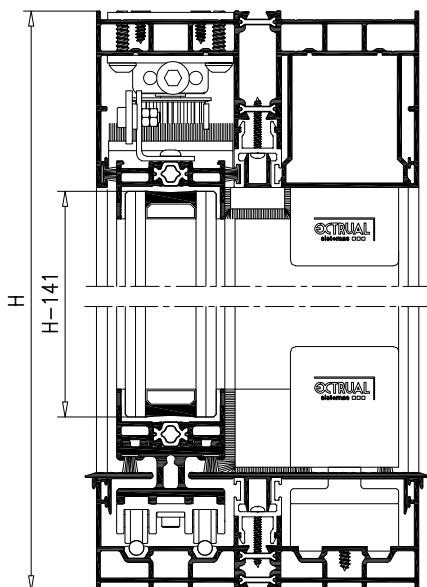

2L + 181

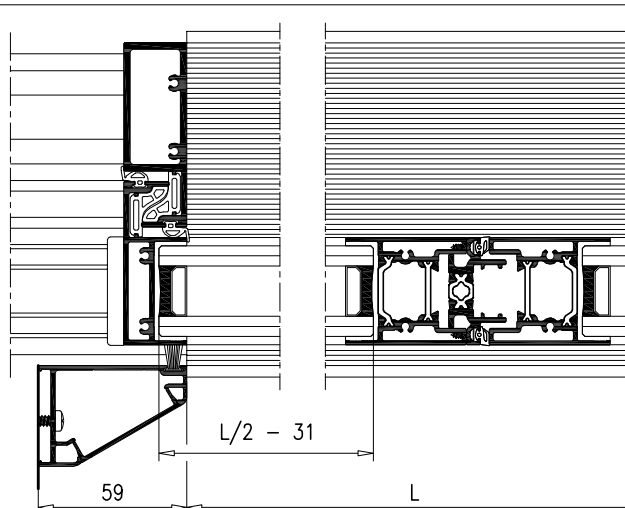

BALCONERA 1+1 HOJAS ENTREMUROS
Marco Inferior Oculto Piso Corrido

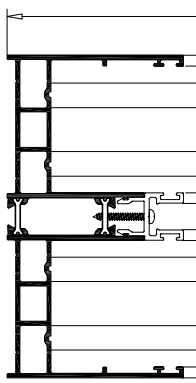
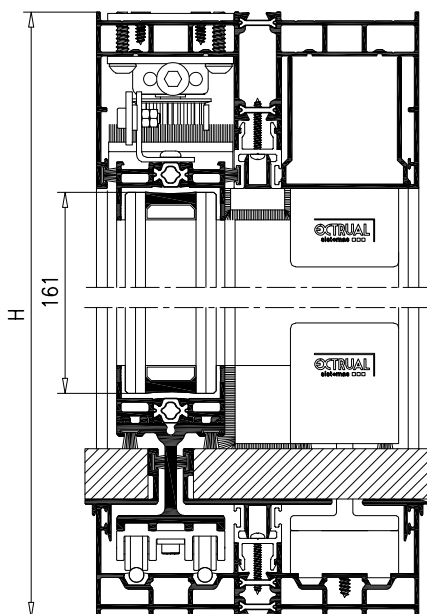

2L + 181

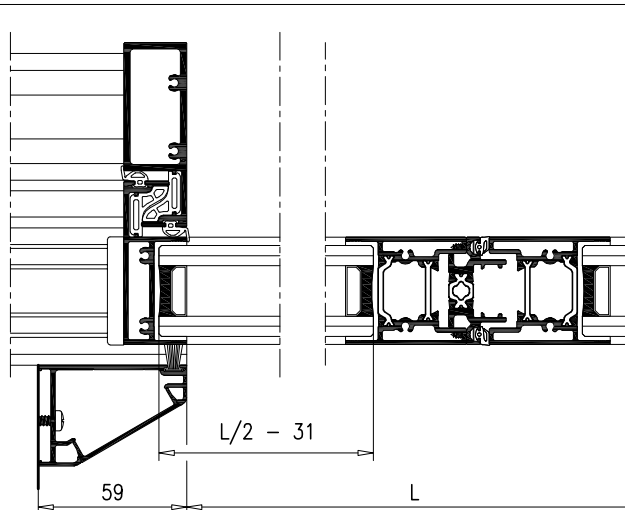

BALCONERA 1+1 HOJAS ENTREMUROS

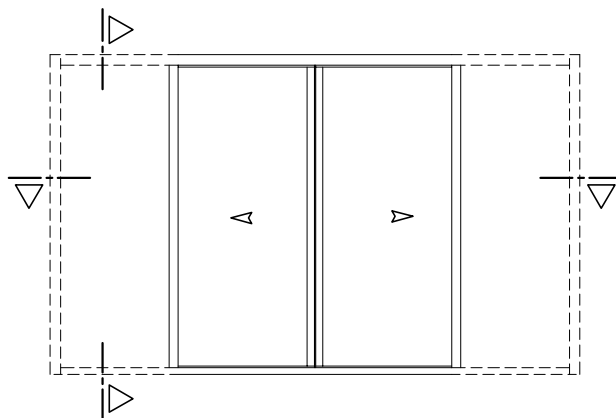

ES NECESARIO HACER REGISTRO PARA ACCEDER A LAS ZONAS DE MOTORES Y DE CONECTORES DE HOJA

PERFILES

REFERENCIA	DENOMINACION	MARCO INFERIOR VISTO		MARCO INFERIOR OCULTO TAPAS ALUMINIO		MARCO INFERIOR OCULTO PISO CORRIDO	
		CANT.	CORTE	CANT.	CORTE	CANT.	CORTE
R-954	MARCO LAT/SUP +38.PP.020	2	H	2	H	2	H
		1	2L+41	1	2L+41	1	2L+41
R-941	MARCO INFERIOR +38.PP.020	1	2L+41	1	2L+41	1	2L+41
16.350	PERFIL DE CIERRE	2	H-60	2	H-60	2	H-60
R-943	HOJA LATERAL	2	H-140	2	H-163	2	H-183
R-945	HOJA SUP/INF	4	(L/2)+9	4	(L/2)+9	4	(L/2)+9
16.349	SUPLEMENT. HOJA			2	(L/2)+9		
16.651	SUPLEMENT. HOJA					2	(L/2)+9
16.347	HOJA DE CIERRE	2	H-140	2	H-163	2	H-183
R-946	CIERRE 4 HOJAS	1	H-94		H-119		H-139
16.342	TAPA CANAL	2	L	2	L	2	L
16.858	TAPA MARCO LAT/SUP	1	L	1	L	1	L
16.343	TAPA MARCO INFERIOR	1	L				
13.248	CIERRE ENTREMUROS	1	H-115	1	H-115	1	H-137
7.438	TAPETA PARA 13.248	1	H-115	1	H-115	1	H-137
16.345*	TAPA LATERAL			1	L	1	L
16.346*	TAPA DOBLE			1	L		
16.653*	TAPA LATERAL					1	L
16.654*	TAPA MULTIPLE					1	L
R-948	SOLERA	1	2L+37	1	2L+37	1	2L+37
15.686	TAPA CANALETA	1	L-4	1	L-4		
16.351	CANALETA DRENAJE	1	L-4	1	L-4	1	L-4

ACCESORIOS

REFERENCIA	DENOMINACION	M.INF. VISTO	M.INF. OCULTO TAPAS ALUMINIO	M.INF. OCULTO PISO CORRIDO
		UNIDADES	UNIDADES	UNIDADES
04.MOT.006	Kit Motor	2	2	2
04.MOT.009	Correa 14mts	1	1	1
04.MOT.010	Correa 30mts			
04.MOT.011	Conector Hoja	2	2	2
04.MOT.013	Electrocerradura	2	2	2
04.MOT.014	Transformador	2	2	2
04.MOT.016	Botonera	2	2	2
04.MOT.017	Gateway	2	2	2
04.AC.067	Kit Hoja Lateral	2	2	2
04.AC.082	Kit Hoja Central	2		
04.AC.083	Kit H.Central M.Inf. Oculto Tapas Aluminio		2	
04.AC.084	Kit H.Central M.Inf. Oculto Piso Corrido			2
04.AC.070	Tapa H.Lateral M.Inf. Oculto Tapas Aluminio		2	
04.AC.079	Tapa H.Lateral M.Inf. Oculto Piso Corrido			2
04.AC.071	Kit Cortavientos	2	2	2
04.AC.076	Tope Inf. 4 Hojas Marco Inf. Oculto		1	1
04.TO.026	Tocho unión Marco	8	8	8
04.AC.F10	Felpudo Marco Sup/Inf	4L	2L	4L
04.AC.F11	Felpudo Cierre Entremuros	2H	2H	2H
04.AC.F09	Felpudo Suplementos Hoja 16.349 y 16.651		2L	2L
04.JU.004.E	Junta Cierre 4 Hojas	2H	2H	2H
04.JU.062	Junta Cruce Central	4H	4H	4H
04.JU.067	Junta Cruce Central	4H	4H	4H
04.JU.068	Junta Tapa canal Marco	2L	2L	2L
04.JU.069	Junta Carril	x2	2L-60	2L-60
04.AC.R150	Carril Acero Inox.	x2	2L-60	2L-60
04.AC.R152	Rodamiento	4	4	4
04.AC.R153	Kit Angulo Rod. M.Inf. Oculto Tapas Aluminio		2	
04.AC.R154	Kit Angulo Rod. M.Inf. Oculto Piso Corrido			2
04.TA.070	Tapa para Canaleta	2	2	2
04.TA.071	Tapa para Solera	2	2	2
04.AC.073	Calzo Vidrio	Según dimensiones de Vidrio		

*Se indica la longitud total necesaria. Las tapas se colocan en tramos para permitir el montaje.

En caso de piso corrido las tapas que ocultan el marco inferior deben de ser registrables para permitir sacar las hojas en caso de necesidad.

BALCONERA 2 HOJAS ENTREMUROS

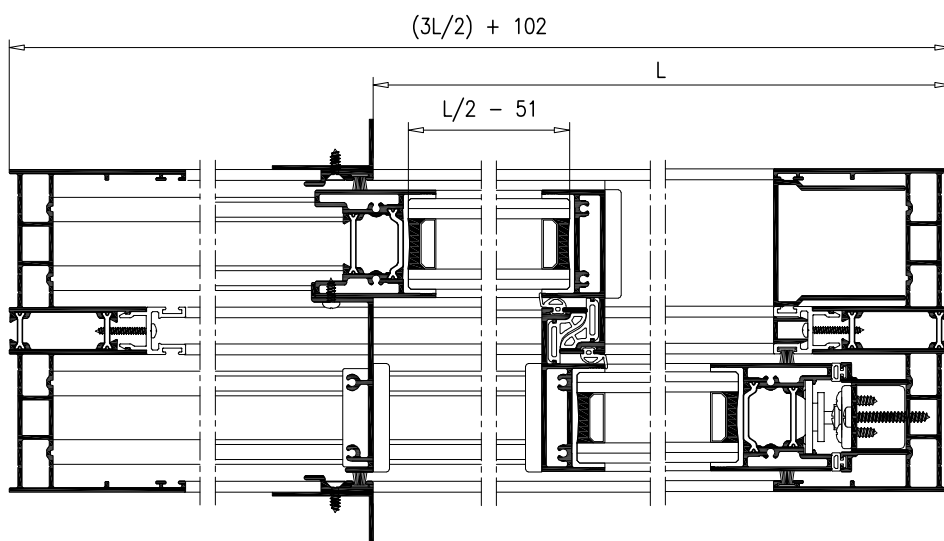
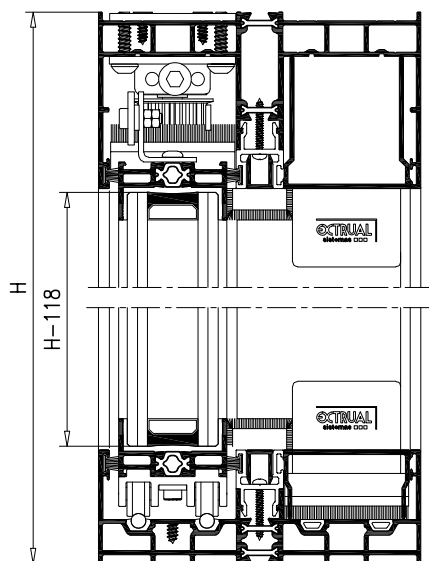

BALCONERA 2 HOJAS ENTREMUROS
Marco Inferior Oculto Tapas de Aluminio

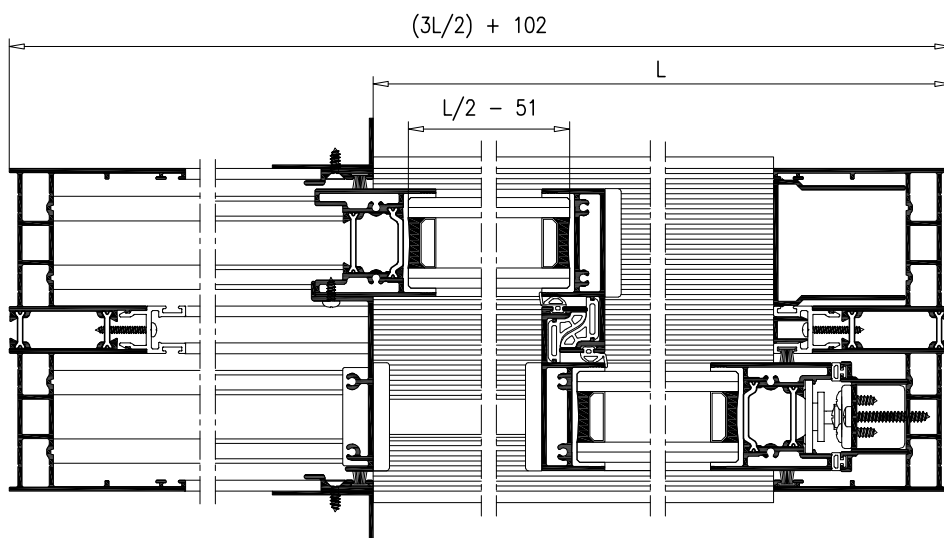
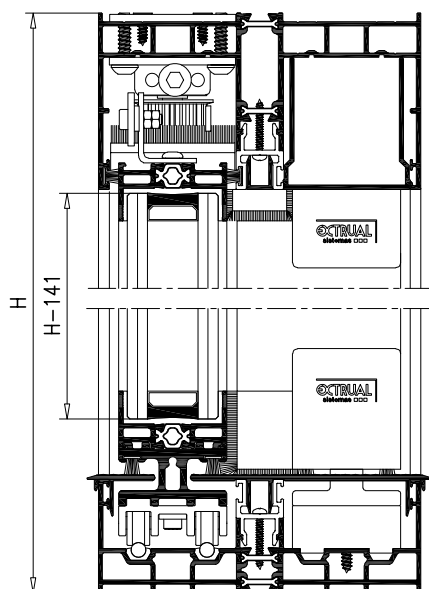



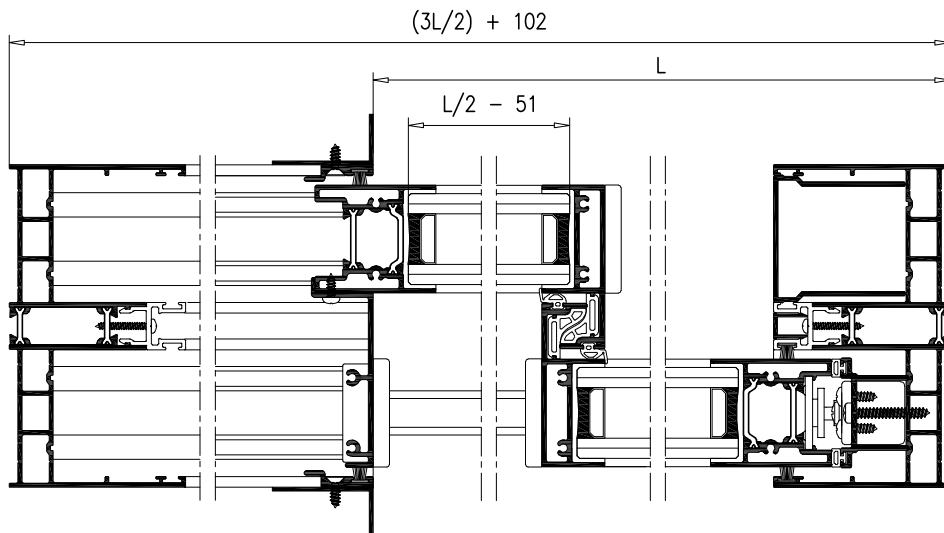
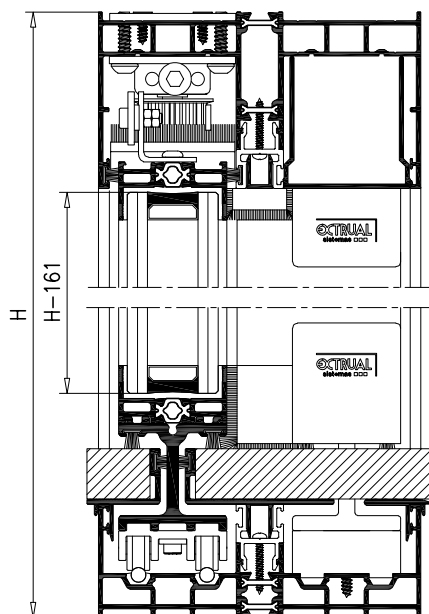





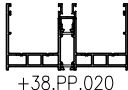
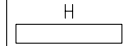
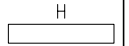
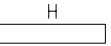
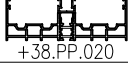
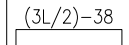
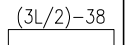
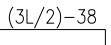

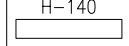
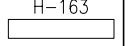
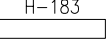

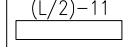
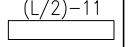
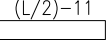

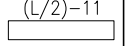

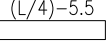

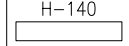
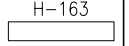
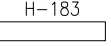

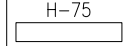
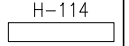
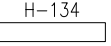
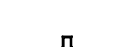
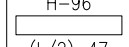
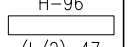
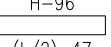
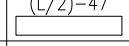
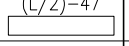
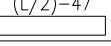

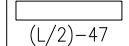
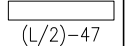
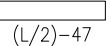
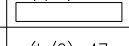
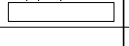
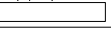

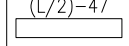

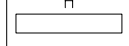
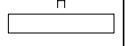
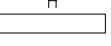

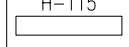
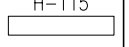
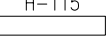
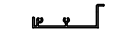
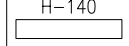
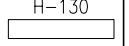
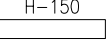

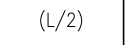
BALCONERA 2 HOJAS ENTREMUROS
Marco Inferior Oculto Piso Corrido

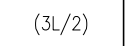
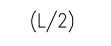
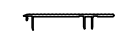
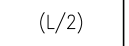
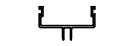
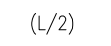

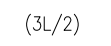
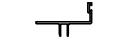
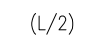
BALCONERA 2 HOJAS ENTREMUROS

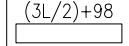
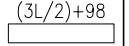
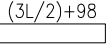
PERFILES

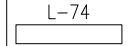
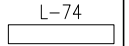
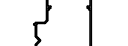
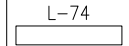
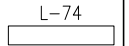
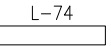
REFERENCIA	DENOMINACION	MARCO INFERIOR VISTO		MARCO INFERIOR OCULTO TAPAS ALUMINIO		MARCO INFERIOR OCULTO PISO CORRIDO	
		CANT.	CORTE	CANT.	CORTE	CANT.	CORTE
R-954	MARCO LAT/SUP  +38.PP.020	2	H 	2	H 	2	H 
R-941	MARCO INFERIOR  +38.PP.020	1	$(3L/2)-38$ 	1	$(3L/2)-38$ 	1	$(3L/2)-38$ 
R-943	HOJA LATERAL 	2	H-140 	2	H-163 	2	H-183 
R-945	HOJA SUP/INF 	4	$(L/2)-11$ 	4	$(L/2)-11$ 	4	$(L/2)-11$ 
16.349	SUPLEMENT. HOJA 			2	$(L/2)-11$ 		
16.651	SUPLEMENT. HOJA 					2	$(L/4)-5.5$ 
16.347	HOJA DE CIERRE 	2	H-140 	2	H-163 	2	H-183 
16.857	CIERRE LATERAL 	1	H-75 	1	H-114 	1	H-134 
16.342	TAPA CANAL 	1	H-96 	1	H-96 	1	H-96 
		4	$(L/2)-47$ 	2	$(L/2)-47$ 	2	$(L/2)-47$ 
16.858	TAPA MARCO LAT/SUP 	1	H-36 	1	H-36 	1	H-36 
		2	$(L/2)-47$ 	1	$(L/2)-47$ 	1	$(L/2)-47$ 
16.343	TAPA MARCO INFERIOR 	1	$(L/2)-47$ 				
16.657	40x20 	2	H 	2	H 	2	H 
16.657	CIERRE ENTREMUROS 	2	H-115 	2	H-115 	2	H-115 
16.658	TAPA LAT. ENTREMUROS 	1	H-140 	1	H-130 	1	H-150 
16.344*	TAPA CENTRAL 				$(L/2)$ 		
16.345*	TAPA LATERAL 				$(3L/2)$ 		$(L/2)$ 
16.346*	TAPA DOBLE 				$(L/2)$ 		
16.652*	TAPA CENTRAL 						$(L/2)$ 
16.653*	TAPA LATERAL 						$(3L/2)$ 
16.654*	TAPA MULTIPLE 						$(L/2)$ 
R-948	SOLERA 	1	$(3L/2)+98$ 	1	$(3L/2)+98$ 	1	$(3L/2)+98$ 
15.686	TAPA CANALETA 	1	L-74 	1	L-74 		
16.351	CANALETA DRENAJE 	1	L-74 	1	L-74 	1	L-74 

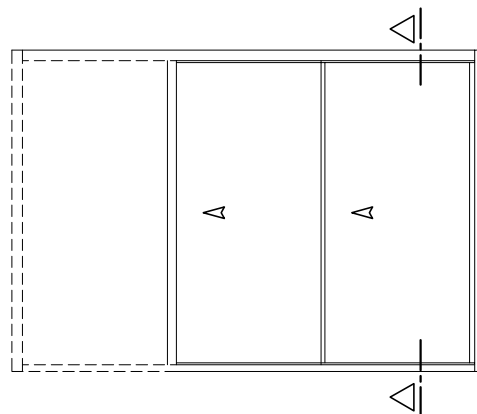

ES NECESARIO HACER REGISTRO PARA ACCEDER A LA ZONA DE MOTORES

ACCESORIOS

REFERENCIA	DENOMINACION	M.INF. VISTO	M.INF. OCULTO TAPAS ALUMINIO	M.INF. OCULTO PISO CORRIDO
		UNIDADES	UNIDADES	UNIDADES
04.MOT.006	Kit Motor	2	2	2
04.MOT.009	Correa 14mts	1	1	1
04.MOT.010	Correa 30mts			
04.MOT.011	Conector Hoja	2	2	2
04.MOT.012	Eletrrocerradura	1	1	1
04.MOT.015	Transformador	1	1	1
04.MOT.016	Botonera	1	1	1
04.MOT.017	Gateway	1	1	1
04.AC.067	Kit Hoja Lateral	2	2	2
04.AC.082	Kit Hoja Central	2		
04.AC.083	Kit H.Central M.Inf. Oculto Tapas Aluminio		2	
04.AC.084	Kit H.Central M.Inf. Oculto Piso Corrido			2
04.AC.070	Tapa H.Lateral M.Inf. Oculto Tapas Aluminio		2	
04.AC.079	Tapa H.Lateral M.Inf. Oculto Piso Corrido			2
04.AC.071	Kit Cortavientos	2		
04.AC.080	Kit Cortavientos Marco Inferior Oculto		2	2
04.AC.085	Taco Estanq. M.Inf. Oculto Tapas Aluminio		1	
04.AC.086	Taco Estanq. M.Inf. Oculto Piso Corrido			1
04.AC.087	Cortavientos Hoja movil	1	1	1
04.TO.026	Tocho unión Marco	8	8	8
04.AC.F10	Felpudo Marco Sup/Inf y cierre entremuros	4L+2H	2L+2H	4L+2H
04.AC.F09	Felpudo Suplementos Hoja 16.349 y 16.651		2L	2L
04.AC.F12	Felpudo Marco Lateral	3H	3H	3H
04.JU.004.D	Junta Cierre Lateral	2H	2H	2H
04.JU.062	Junta Cruce Central	2H	2H	2H
04.JU.067	Junta Cruce Central	2H	2H	2H
04.JU.068	Junta Tapacanal Marco	L	L	L
04.JU.069	Junta Carril	x4	$(3L/2)-150$	$(3L/2)-150$
04.AC.R150	Carril Acero Inox.	x4	$(3L/2)-150$	$(3L/2)-150$
04.AC.R152	Rodamiento	4	4	4
04.AC.R153	Kit Angulo Rod. M.Inf. Oculto Tapas Aluminio		2	
04.AC.R154	Kit Angulo Rod. M.Inf. Oculto Piso Corrido			2
04.TA.070	Tapa para Canaleta	2	2	2
04.TA.071	Tapa para Solera	2	2	2
04.AC.073	Calzo Vidrio	Según dimensiones de Vidrio		

*Se indica la longitud total necesaria. Las tapas se colocan en tramos para permitir el montaje.

El perfil 16.651 se coloca deslizado en la hoja inferior en 2 trozos, para permitir sacar la hoja del marco en caso de necesidad una vez colocado el piso.

En caso de piso corrido las tapas que ocultan el marco inferior deben de ser registrables para permitir sacar las hojas en caso de necesidad.

BALCONERA 2+2 HOJAS ENTREMUROS

$(3L/2) + 248$

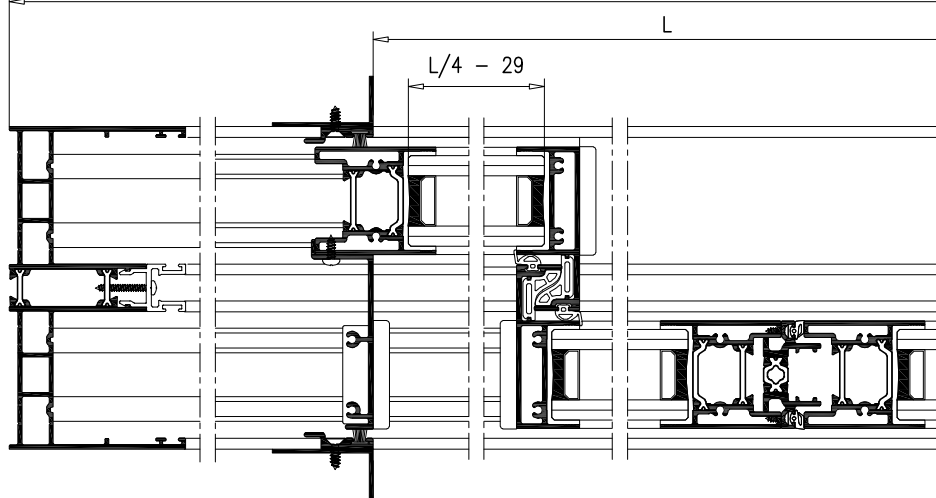
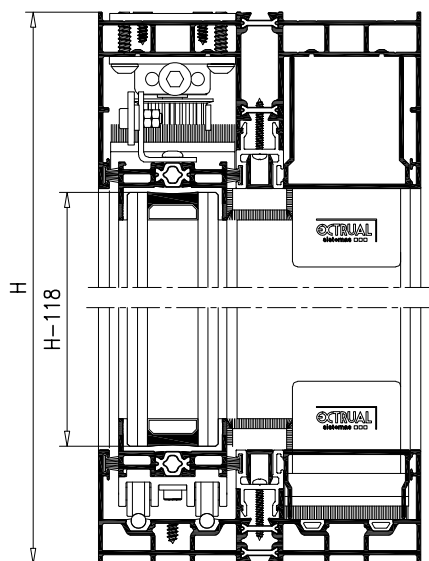

BALCONERA 2+2 HOJAS ENTREMUROS
Marco Inferior Oculto Tapas de Aluminio

$(3L/2) + 248$

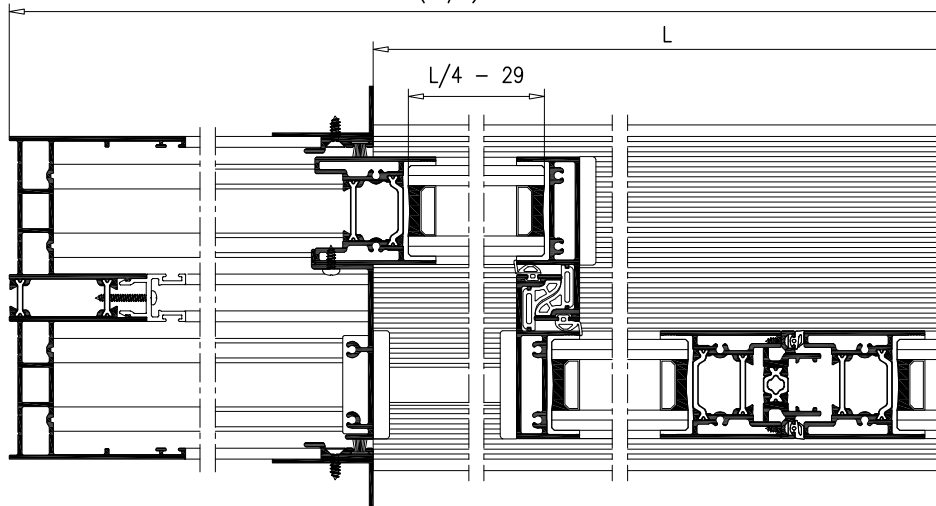
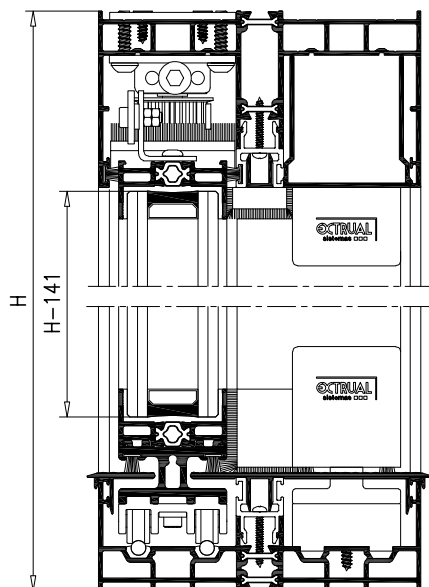

BALCONERA 2+2 HOJAS ENTREMUROS
Marco Inferior Oculto Piso Corrido

$(3L/2) + 248$

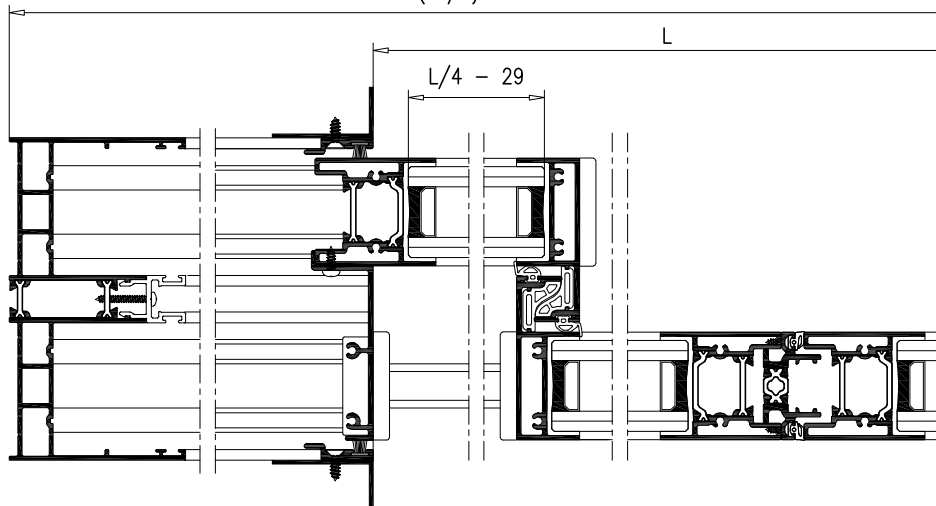
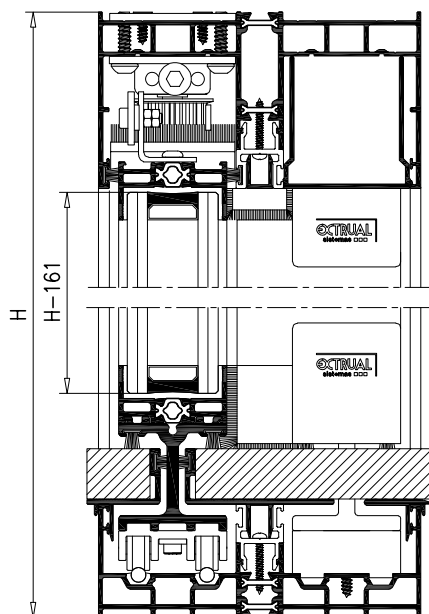

BALCONERA 2+2 HOJAS ENTREMUROS

PERFILES

REFERENCIA	DENOMINACION	MARCO INFERIOR VISTO		MARCO INFERIOR OCULTO TAPAS ALUMINIO		MARCO INFERIOR OCULTO PISO CORRIDO	
		CANT.	CORTE	CANT.	CORTE	CANT.	CORTE
R-954	MARCO LAT/SUP +38.PP.020	2 1	H (3L/2)+208	2 1	H (3L/2)+208	2 1	H (3L/2)+208
R-941	MARCO INFERIOR +38.PP.020	1	(3L/2)+208	1	(3L/2)+208	1	(3L/2)+208
R-943	HOJA LATERAL	4	H-140	4	H-163	4	H-183
R-945	HOJA SUP/INF	8	(L/4)+10	8	(L/4)+10	8	(L/4)+10
16.349	SUPLEMENT. HOJA			4	(L/4)+10		
16.651	SUPLEMENT. HOJA					4	(L/4)+10
16.347	HOJA DE CIERRE	4	H-140	4	H-163	4	H-183
R-946	CIERRE 4 HOJAS	1	H-94		H-119		H-139
16.342	TAPA CANAL	4 2	(L/4)-26 (L/2)+3	2 1	(L/4)-26 (L/2)+3	2 1	(L/4)-26 (L/2)+3
16.858	TAPA MARCO LAT/SUP	1	(L/2)+3	1	(L/2)+3	1	(L/2)+3
16.343	TAPA MARCO INFERIOR	1	(L/2)+3				
5.787	40x20	4	H	4	H	4	H
16.657	CIERRE ENTREMUROS	4	H-115	4	H-115	4	H-115
16.658	TAPA LAT. ENTREMUROS	2	H-140	2	H-130	2	H-150
16.344*	TAPA CENTRAL				L/2		
16.345*	TAPA LATERAL				L+L/2		L/2
16.346*	TAPA DOBLE				L/2		
16.652*	TAPA CENTRAL						L/2
16.653*	TAPA LATERAL						L+L/2
16.654*	TAPA MULTIPLE						L/2
R-948	SOLERA	1	(3L/2)+244	1	(3L/2)+244	1	(3L/2)+244
15.686	TAPA CANALETA	1	L-4	1	L-4		
16.351	CANALETA DRENAJE	1	L-4	1	L-4	1	L-4

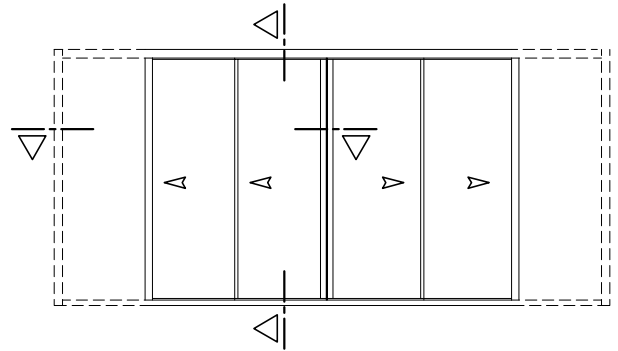

ES NECESARIO HACER REGISTRO PARA ACCEDER A LA ZONA DE MOTORES

Aperturas independientes (2 pulsadores)

ACCESORIOS

REFERENCIA	DENOMINACION	M.INF. VISTO	M.INF. OCULTO TAPAS ALUMINIO	M.INF. OCULTO PISO CORRIDO
		UNIDADES	UNIDADES	UNIDADES
04.MOT.006	Kit Motor	4	4	4
04.MOT.009	Correa 14mts	2 6 4	2 6 4	2 6 4
04.MOT.010	Correa 30mts			
04.MOT.011	Conector Hoja	4	4	4
04.MOT.013	Electrocerradura	2	2	2
04.MOT.015	Transformador	2	2	2
04.MOT.016	Botonera	2	2	2
04.MOT.017	Gateway	2	2	2
04.AC.067	Kit Hoja Lateral	4	4	4
04.AC.082	Kit Hoja Central	4		
04.AC.083	Kit H.Central M.Inf. Oculto Tapas Aluminio		4	
04.AC.084	Kit H.Central M.Inf. Oculto Piso Corrido			4
04.AC.070	Tapa H.Lateral M.Inf. Oculto Tapas Aluminio		4	
04.AC.079	Tapa H.Lateral M.Inf. Oculto Piso Corrido			4
04.AC.071	Kit Cortavientos	4	1	1
04.AC.080	Kit Cortavientos Marco Inferior Oculto		2	2
04.AC.087	Cortavientos Hoja movil	2	2	2
04.AC.076	Tope Inf. 4 Hojas Marco Inf. Oculto		1	1
04.TO.026	Tocho unión Marco	8	8	8
04.AC.F10	Felpudo Marco Sup/Inf y cierre entremuros	4L+4H	2L+4H	4L+4H
04.AC.F09	Felpudo Suplementos Hoja 16.349 y 16.651		2L	2L
04.JU.004.E	Junta Cierre 4 Hojas	2H	2H	2H
04.JU.062	Junta Cruce Central	4H	4H	4H
04.JU.067	Junta Cruce Central	4H	4H	4H
04.JU.068	Junta Tapa canal Marco	1.5mts	1.5mts	1.5mts
04.JU.069	Junta Carril	x4 (3L/2)+50	(3L/2)+50	(3L/2)+50
04.AC.R150	Carril Acero Inox.	x4 (3L/2)+50	(3L/2)+50	(3L/2)+50
04.AC.R152	Rodamiento	8	8	8
04.AC.R153	Kit Angulo Rod. M.Inf. Oculto Tapas Aluminio		4	
04.AC.R154	Kit Angulo Rod. M.Inf. Oculto Piso Corrido			4
04.TA.070	Tapa para Canaleta	2	2	2
04.TA.071	Tapa para Solera	2	2	2
04.AC.073	Calzo Vidrio	Según dimensiones de Vidrio		

*Se indica la longitud total necesaria. Las tapas se colocan en tramos para permitir el montaje.

En caso de piso corrido las tapas que ocultan el marco inferior deben de ser registrables para permitir sacar las hojas en caso de necesidad.

BALCONERA 3 HOJAS ENTREMUROS

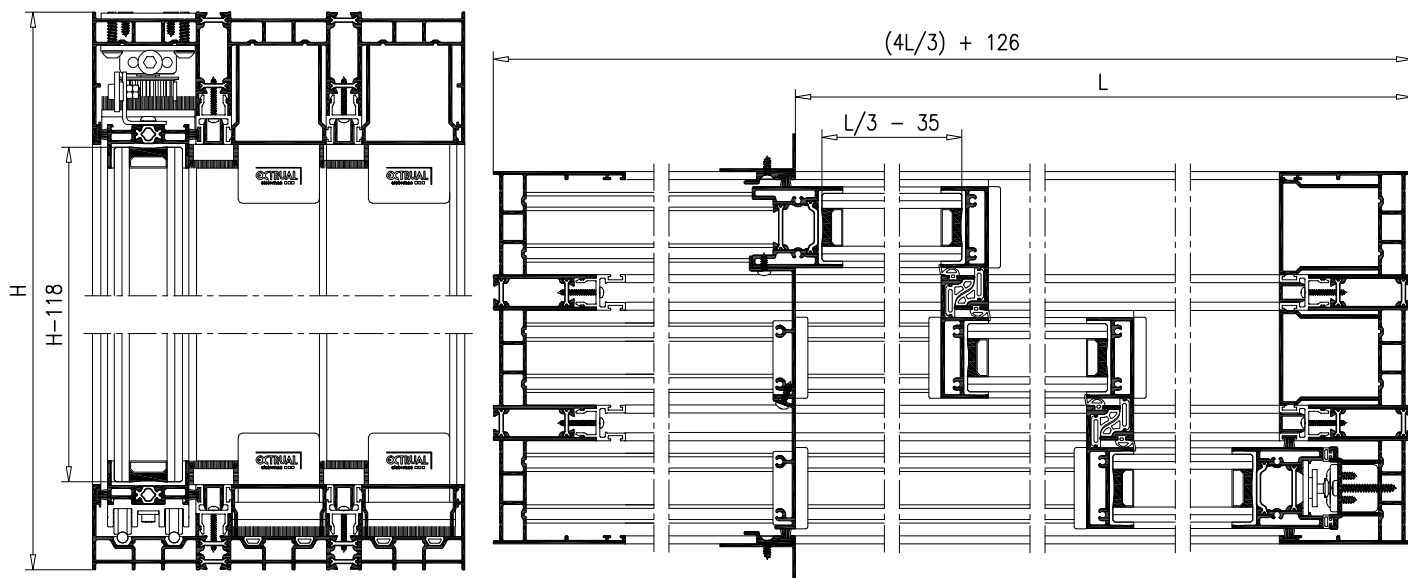

BALCONERA 3 HOJAS ENTREMUROS Marco Inferior Oculto Tapas de Aluminio

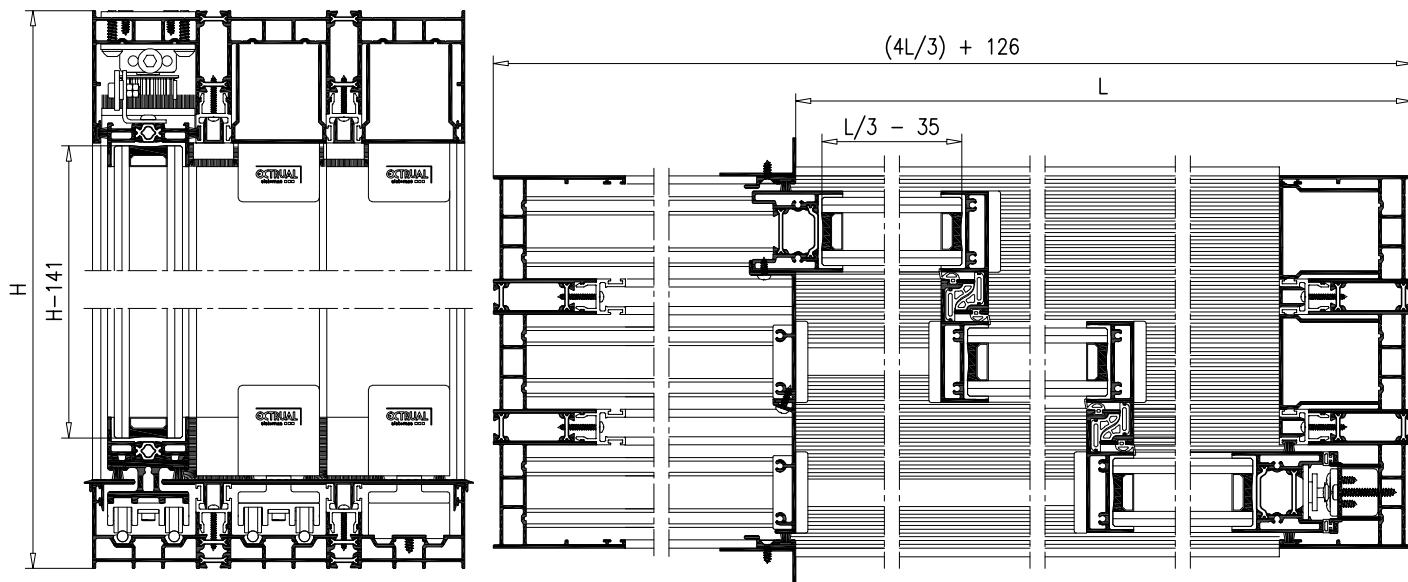

BALCONERA 3 HOJAS ENTREMUROS Marco Inferior Oculto Piso Corrido

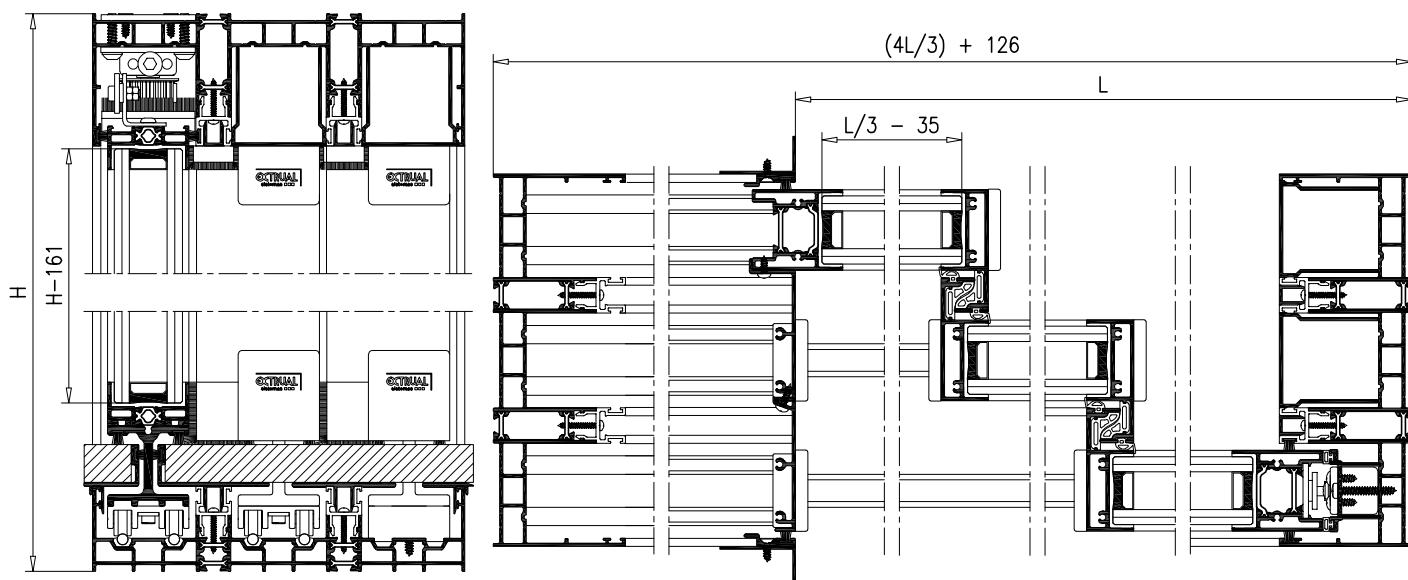

BALCONERA 3 HOJAS ENTREMUROS

PERFILES

REFERENCIA	DENOMINACION	MARCO INFERIOR VISTO		MARCO INFERIOR OCULTO TAPAS ALUMINIO		MARCO INFERIOR OCULTO PISO CORRIDO	
		CANT.	CORTE	CANT.	CORTE	CANT.	CORTE
R-955	MARCO LAT/SUP +38.PP.020 (x2)	2	H (4L/3)-14	2	H (4L/3)-14	2	H (4L/3)-14
R-942	MARCO INFERIOR +38.PP.020 (x2)	1	(4L/3)-14	1	(4L/3)-14	1	(4L/3)-14
R-943	HOJA LATERAL	2	H-140	2	H-163	2	H-183
R-945	HOJA SUP/INF	4	(L/3)+5 (L/3)-7	4	(L/3)+5 (L/3)-7	4	(L/3)+5 (L/3)-7
16.349	SUPLEMENT. HOJA			2	(L/3)+5 (L/3)-7		
16.651	SUPLEMENT. HOJA					2	(L/3)+5 (L/3)-7
16.347	HOJA DE CIERRE	4	H-140	4	H-163	4	H-183
16.857	CIERRE LATERAL	1	H-75	1	H-114	1	H-134
16.342	TAPA CANAL	2	H-96 (L/3)-32	2	H-96 (L/3)-32	2	H-96 (L/3)-32
16.858	TAPA MARCO LAT/SUP	4	(2L/3)-63	2	(2L/3)-63	2	(2L/3)-63
16.343	TAPA MARCO INFERIOR	2	H-75 (L/3)-32 (2L/3)-63	2	H-75 (L/3)-32 (2L/3)-63	2	H-75 (L/3)-32 (2L/3)-63
16.657	40x20	1	H	1	H	1	H
16.657	CRUCE ENTREMUROS	1	H-115	1	H-115	1	H-115
16.658	TAPA LAT. ENTREMUROS	1	H-140	1	H-130	1	H-150
16.659	TAPA LAT. ENTREMUROS	1	H-140	1	H-130	1	H-150
16.344*	TAPA CENTRAL				L		
16.345*	TAPA LATERAL				(4L/3)		(L/3)
16.346*	TAPA DOBLE				(L/3)		(L/3)
16.608*	TAPA TRIPLE				(L/3)		
16.652*	TAPA CENTRAL						L
16.653*	TAPA LATERAL						(4L/3)
16.654*	TAPA MULTIPLE						(2L/3)
R-949	SOLERA	1	L-4	1	L-4	1	L-4
15.686	TAPA CANALETA	1	L-144	1	L-144		
16.351	CANALETA DRENAJE	1	L-194	1	L-144	1	L-144

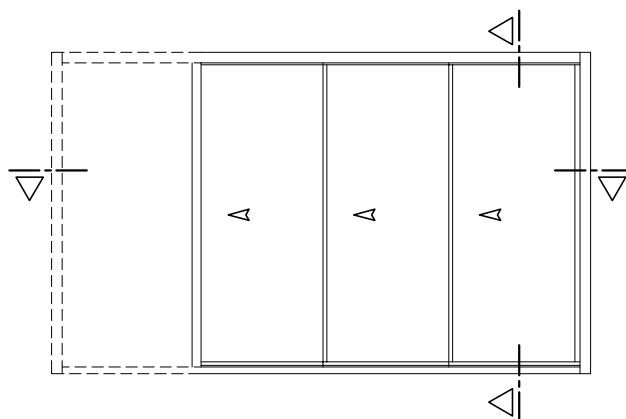

ES NECESARIO HACER REGISTRO PARA ACCEDER A LA ZONA DE MOTORES

ACCESORIOS

REFERENCIA	DENOMINACION	M.INF. VISTO	M.INF. OCULTO TAPAS ALUMINIO	M.INF. OCULTO PISO CORRIDO
		UNIDADES	UNIDADES	UNIDADES
04.MOT.006	Kit Motor	3	3	3
04.MOT.009	Correa 14mts	3	3	3
04.MOT.010	Correa 30mts			
04.MOT.011	Conector Hoja	3	3	3
04.MOT.012	Electrocerradura	1	1	1
04.MOT.015	Transformador	1	1	1
04.MOT.016	Botonera	1	1	1
04.MOT.017	Gateway	1	1	1
04.AC.067	Kit Hoja Lateral	2	2	2
04.AC.082	Kit Hoja Central	4		
04.AC.083	Kit H.Central M.Inf. Oculto Tapas Aluminio		4	
04.AC.084	Kit H.Central M.Inf. Oculto Piso Corrido			4
04.AC.070	Tapa H.Lateral M.Inf. Oculto Tapas Aluminio		2	
04.AC.079	Tapa H.Lateral M.Inf. Oculto Piso Corrido			2
04.AC.071	Kit Cortavientos	4		
04.AC.080	Kit Cortavientos Marco Inferior Oculto	2	2	2
04.AC.085	Taco Estanq. M.Inf. Oculto Tapas Aluminio		1	
04.AC.086	Taco Estanq. M.Inf. Oculto Piso Corrido			1
04.AC.087	Cortavientos Hoja movil	4	4	4
04.TO.026	Tocho unión Marco	12	12	12
04.AC.F10	Felpudo Marco Sup/Inf y cierre entremuros	4L+2H	2L+2H	6L+2H
04.AC.F09	Felpudo Suplementos Hoja 16.349 y 16.651		2L	2L
04.AC.F12	Felpudo Marco Lateral	2H	2H	2H
04.JU.004.D	Junta Cierre Lateral	2H	2H	2H
04.JU.062	Junta Cruce Central	4H	4H	4H
04.JU.067	Junta Cruce Central	4H	4H	4H
04.JU.068	Junta Tapa canal Marco	2L	2L	2L
04.JU.069	Junta Carril	x6 (4L/2)-120	(4L/2)-120	(4L/2)-120
04.AC.R150	Carril Acero Inox.	x6 (4L/2)-120	(4L/2)-120	(4L/2)-120
04.AC.R152	Rodamiento	6	6	6
04.AC.R153	Kit Angulo Rod. M.Inf. Oculto Tapas Aluminio		3	
04.AC.R154	Kit Angulo Rod. M.Inf. Oculto Piso Corrido			3
04.TA.070	Tapa para Canaleta	2	2	2
04.TA.071	Tapa para Solera	2	2	2
04.AC.073	Calzo Vidrio	Según dimensiones de Vidrio		

*Se indica la longitud total necesaria. Las tapas se colocan en tramos para permitir el montaje.

En caso de piso corrido las tapas que ocultan el marco inferior deben de ser registrables para permitir sacar las hojas en caso de necesidad.

BALCONERA EN ESQUINA SALIENTE 2 HOJAS + 2 FIJOS

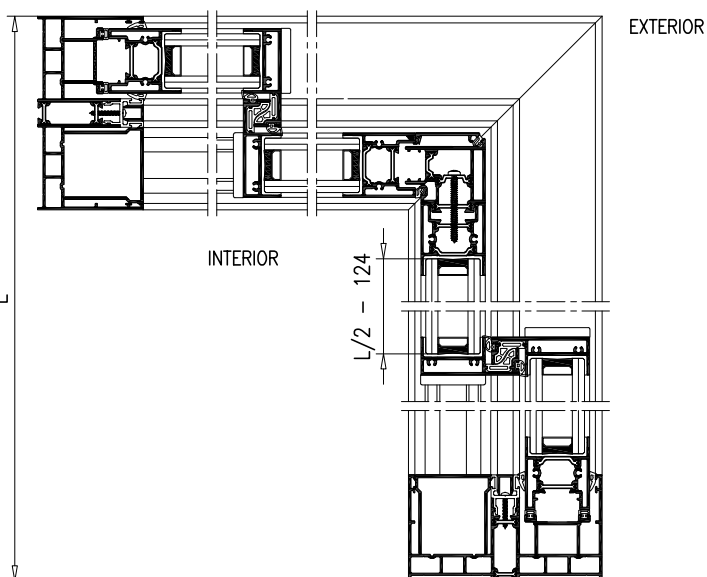
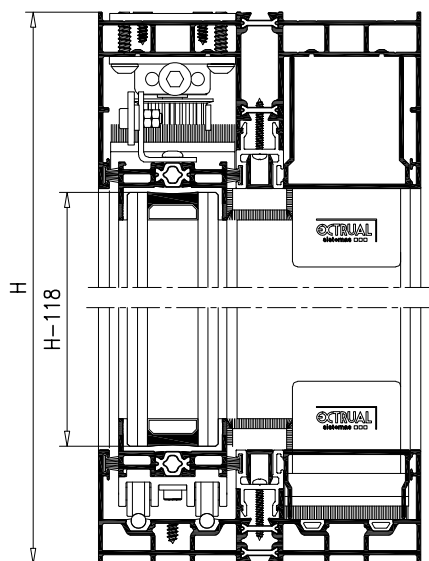

BALCONERA EN ESQUINA SALIENTE 2 HOJAS + 2 FIJOS
Marco Interior Oculto Tapas de Aluminio

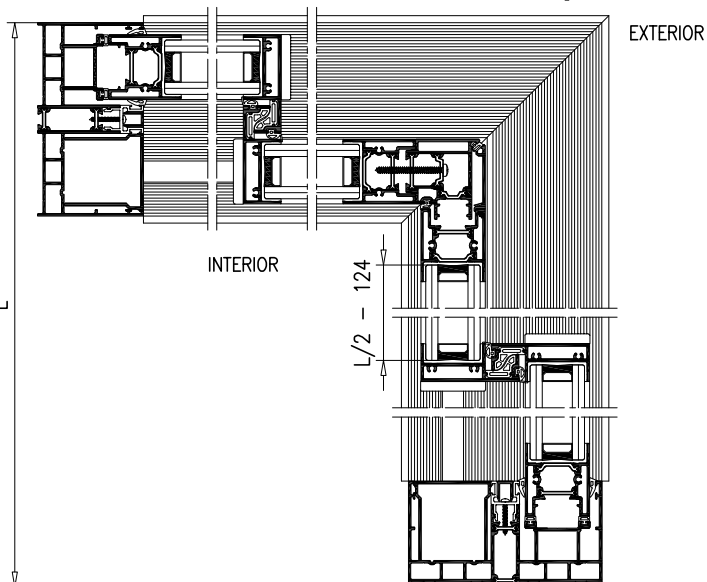
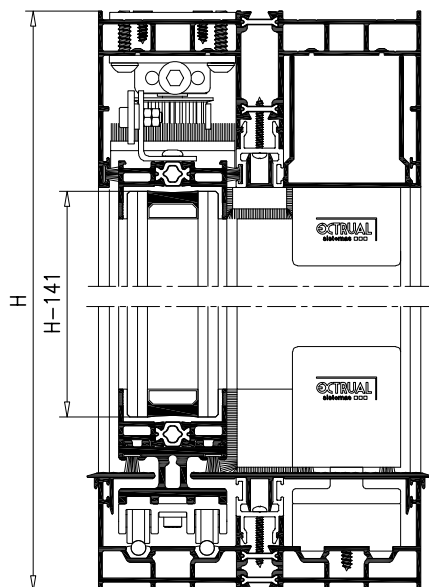



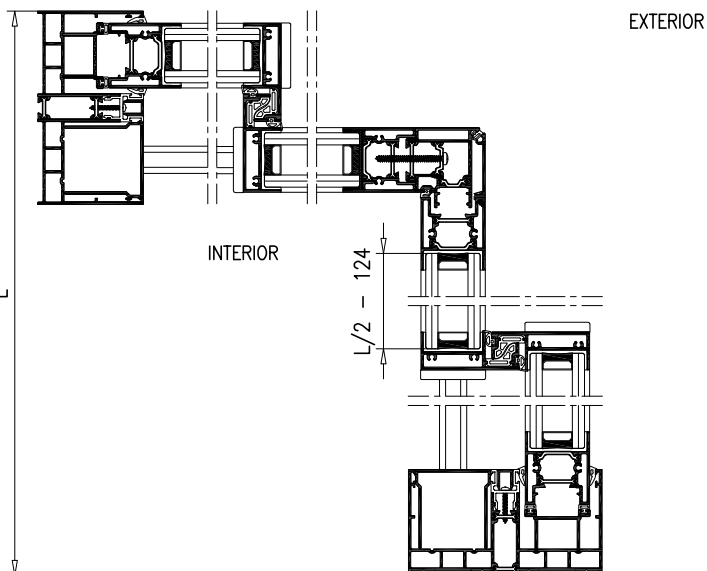
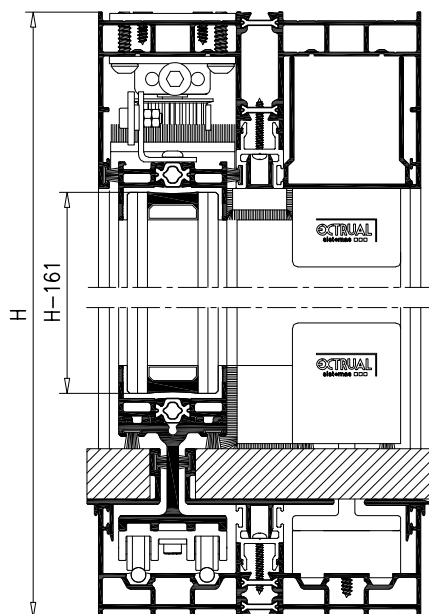





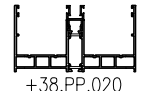
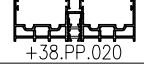











BALCONERA EN ESQUINA SALIENTE 2 HOJAS + 2 FIJOS
Marco Inferior Oculto Piso Corrido



BALCONERA EN ESQUINA SALIENTE 2 HOJAS + 2 FIJOS

PERFILES

REFERENCIA	DENOMINACION	MARCO INFERIOR VISTO		MARCO INFERIOR OCULTO TAPAS ALUMINIO		MARCO INFERIOR OCULTO PISO CORRIDO		
		CANT.	CORTE	CANT.	CORTE	CANT.	CORTE	
R-954	 +38.PP.020	MARCO LAT/SUP	2	H	2	H	2	H
			1	L-70	1	L-70	1	L-70
R-941	 +38.PP.020	MARCO INFERIOR	1	L-70	1	L-70	1	L-70
R-943		HOJA LATERAL	4	H-140	4	H-163	4	H-183
R-945		HOJA SUP/INF	8	(L/2)-84	8	(L/2)-84	8	(L/2)-84
16.349		SUPLEMENT. HOJA			4	(L/2)-84		
16.651		SUPLEMENT. HOJA					8	(L/4)-42
16.347		HOJA DE CIERRE	4	H-140	4	H-163	4	H-183
R-947		HOJA ESQUINA	1	H-94	1	H-117	1	H-137
16.358		CIERRE ESQUINA	1	H-94	1	H-117	1	H-137
16.857		CIERRE LATERAL	2	H-75	2	H-114	2	H-134
16.342		TAPA CANAL	2	H-96	2	H-96	2	H-96
			4	(L/2)-33	2	(L/2)-33	2	(L/2)-33
			4	(L/2)-120	2	(L/2)-120	2	(L/2)-120
16.858		TAPA MARCO LAT/SUP	2	H-75	2	H-75	2	H-75
			2	(L/2)+21	2	(L/2)+21	2	(L/2)+21
16.343		TAPA MARCO INFERIOR	2	(L/2)+21				
16.344*		TAPA CENTRAL			2	(L/2)-91		
16.345*		TAPA LATERAL			2	(L/2)-91		(L/2)+26
					2	L-175		
16.346*		TAPA DOBLE			2	(L/2)+26		
16.652*		TAPA CENTRAL					2	(L/2)-91
16.653*		TAPA LATERAL					2	(L/2)-91
							2	L-173
16.654*		TAPA MULTIPLE					2	(L/2)-13
R-948		SOLERA	1	L-2	1	L-2	1	L-2
15.686		TAPA CANALETA	1	L+19	1	L+19		
16.351		CANALETA DRENAJE	1	L+21	1	L+21	1	L+21

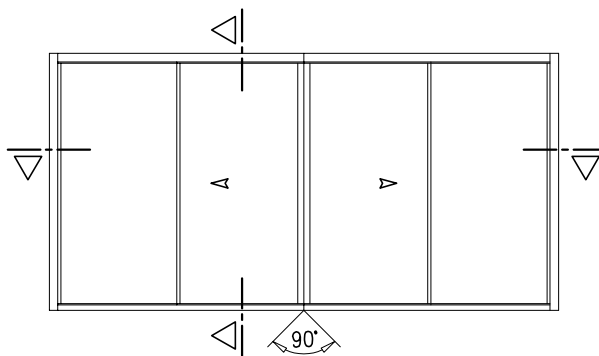

ACCESORIOS

REFERENCIA	DENOMINACION	M.INF. VISTO	M.INF. OCULTO TAPAS ALUMINIO	M.INF. OCULTO PISO CORRIDO
		UNIDADES	UNIDADES	UNIDADES
04.MOT.006	Kit Motor	2	2	2
04.MOT.009	Correa 14mts	1 6 2	1 6 2	1 6 2
04.MOT.010	Correa 30mts			
04.MOT.011	Conector Hoja	2	2	2
04.MOT.013	Eletrocerradura	1	1	1
04.MOT.015	Transformador	1	1	1
04.MOT.016	Botonera	1	1	1
04.MOT.017	Gateway	1	1	1
04.AC.067	Kit Hoja Lateral	4	4	4
04.AC.082	Kit Hoja Central	4		
04.AC.083	Kit H.Central M.Inf. Oculto Tapas Aluminio		4	
04.AC.084	Kit H.Central M.Inf. Oculto Piso Corrido			4
04.AC.070	Tapa H.Lateral M.Inf. Oculto Tapas Aluminio		4	
04.AC.079	Tapa H.Lateral M.Inf. Oculto Piso Corrido			4
04.AC.071	Kit Cortavientos	2		
04.AC.080	Kit Cortavientos Marco Inferior Oculto		2	2
04.AC.085	Taco Estanq. M.Inf. Oculto Tapas Aluminio		2	
04.AC.086	Taco Estanq. M.Inf. Oculto Piso Corrido			2
04.AC.077	Kit Cierre Esquina Marco Inf. Oculto		1	1
04.AC.087	Cortavientos Hoja movil	2	2	2
04.TO.026	Tocho unión Marco Superior	8	8	8
04.ES.084	Escuadra Marco Esquina	4	4	4
04.AC.F10	Felpudo Marco Sup/Inf	8L	4L	8L
04.AC.F09	Felpudo Suplementos Hoja 16.349 y 16.651		2L	2L
04.JU.004.D	Junta Cierre Lateral	4H	4H	4H
04.JU.004.E	Junta Cierre 4 Hojas	2H	2H	2H
04.JU.062	Junta Cruce Central	4H	4H	4H
04.JU.067	Junta Cruce Central	4H	4H	4H
04.JU.068	Junta Tapacanal Marco	4L	4L	4L
04.JU.069	Junta Carril	4L	4L	4L
04.AC.R150	Carril Acero Inox.	x4	L-220	L-220
04.AC.R152	Rodamiento	4	4	4
04.AC.R153	Kit Angulo Rod. M.Inf. Oculto Tapas Aluminio		2	
04.AC.R154	Kit Angulo Rod. M.Inf. Oculto Piso Corrido			2
04.AC.074	Calzo Hoja Fija	4	4	4
04.JA.004	Junta Hoja Fija	4L+4H	4L+4H	2L+4H
04.TA.070	Tapa para Canaleta	2	2	2
04.TA.071	Tapa para Solera	2	2	2
04.AC.073	Calzo Vidrio	Según dimensiones de Vidrio		

*Se indica la longitud total necesaria. Las tapas se colocan en tramos para permitir el montaje.

El perfil 16.651 se coloca deslizado en la hoja inferior en 2 trozos, para permitir sacar la hoja del marco en caso de necesidad una vez colocado el piso.

En caso de piso corrido las tapas que ocultan el marco inferior deben de ser registrables para permitir sacar las hojas en caso de necesidad.

BALCONERA EN ESQUINA SALIENTE 2 HOJAS + 2 HOJAS

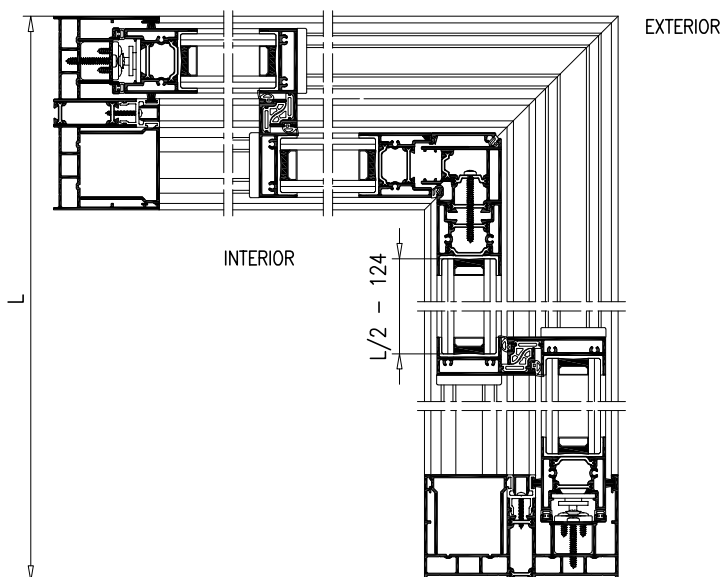
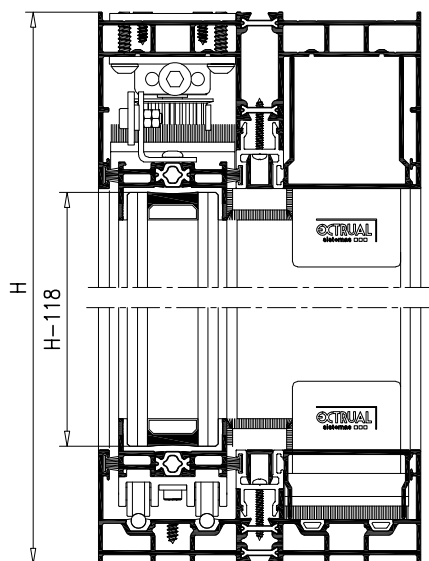

BALCONERA EN ESQUINA SALIENTE 2 HOJAS + 2 HOJAS
Marco Interior Oculto Tapas de Aluminio

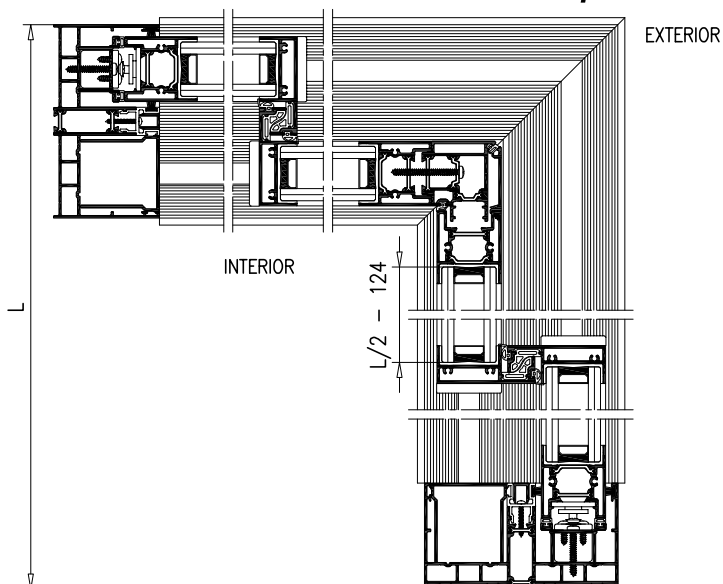
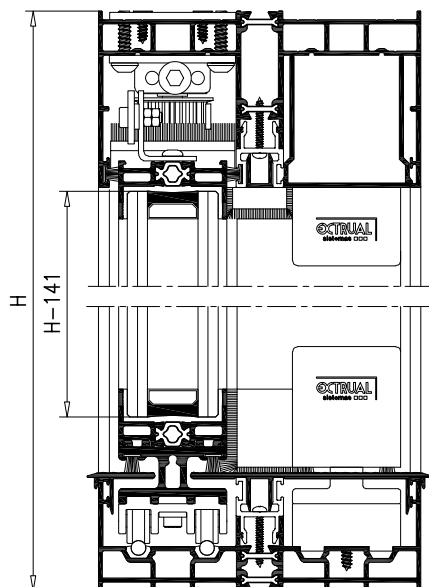

BALCONERA EN ESQUINA SALIENTE 2 HOJAS + 2 HOJAS
Marco Inferior Oculto Piso Corrido

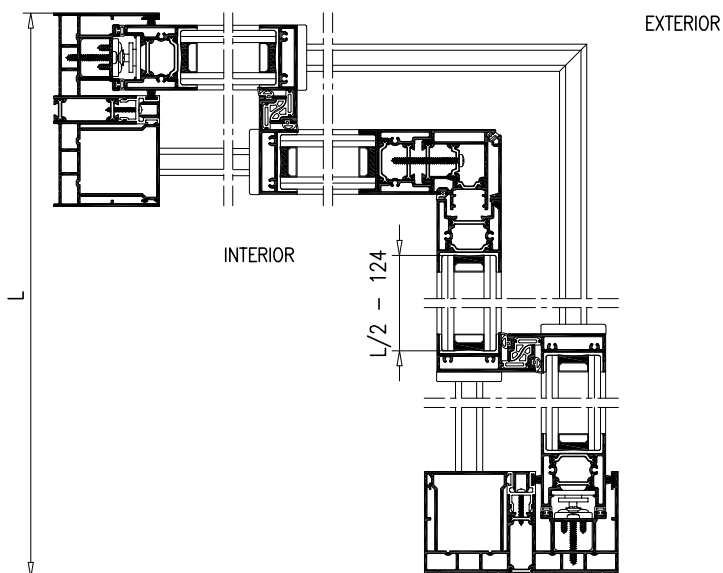
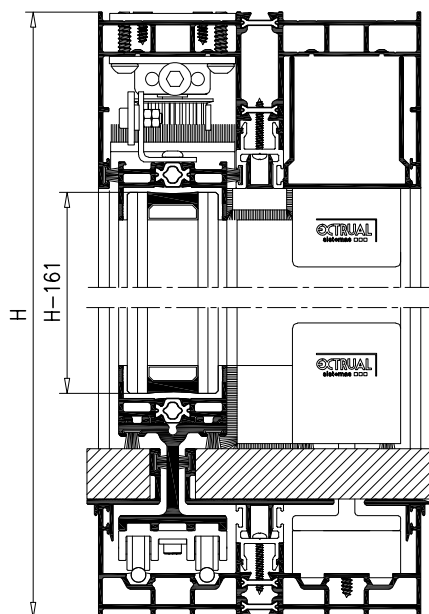

BALCONERA EN ESQUINA SALIENTE 2 HOJAS + 2 HOJAS

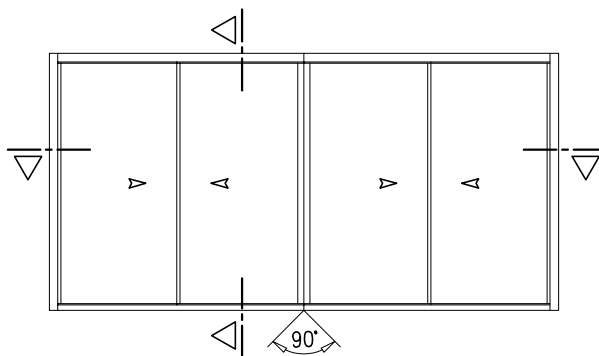

PERFILES

REFERENCIA	DENOMINACION	MARCO INFERIOR VISTO		MARCO INFERIOR OCULTO TAPAS ALUMINIO		MARCO INFERIOR OCULTO PISO CORRIDO	
		CANT.	CORTE	CANT.	CORTE	CANT.	CORTE
R-954	MARCO LAT/SUP +38.PP.020	2 1	H L-70	2 1	H L-70	2 1	H L-70
R-941	MARCO INFERIOR +38.PP.020	1	L-70	1	L-70	1	L-70
R-943	HOJA LATERAL 	4	H-140	4	H-163	4	H-183
R-945	HOJA SUP/INF 	8	(L/2)-84	8	(L/2)-84	8	(L/2)-84
16.349	SUPLEMENT. HOJA 			4	(L/2)-84		
16.651	SUPLEMENT. HOJA 					8	(L/4)-42
16.347	HOJA DE CIERRE 	4	H-140	4	H-163	4	H-183
R-947	HOJA ESQUINA 	1	H-94	1	H-117	1	H-137
16.358	CIERRE ESQUINA 	1	H-94	1	H-117	1	H-137
16.857	CIERRE LATERAL 	2	H-75	2	H-114	2	H-134
16.342	TAPA CANAL 	2 4 4	H-96 (L/2)-33 (L/2)-120	2 2 2	H-96 (L/2)-33 (L/2)-120	2 2 2	H-96 (L/2)-33 (L/2)-120
16.858	TAPA MARCO LAT/SUP 	2	H-75	2	H-75	2	H-75
16.344*	TAPA CENTRAL 			2	L-106		
16.345*	TAPA LATERAL 			2 2	L-66 L-175		
16.652*	TAPA CENTRAL 					2	L-104
16.653*	TAPA LATERAL 					2 2	L-65 L-173
R-948	SOLERA 	1	L-2	1	L-2	1	L-2
15.686	TAPA CANALETA 	1	L+19	1	L+19		
16.351	CANALETA DRENAJE 	1	L+21	1	L+21	1	L+21

ACCESORIOS

REFERENCIA	DENOMINACION	M.INF. VISTO	M.INF. OCULTO TAPAS ALUMINIO	M.INF. OCULTO PISO CORRIDO
		UNIDADES	UNIDADES	UNIDADES
04.MOT.006	Kit Motor	4	4	4
04.MOT.009	Correa 14mts	2 6 4	2 6 4	2 6 4
04.MOT.010	Correa 30mts			
04.MOT.011	Conector Hoja	4	4	4
04.MOT.012	Eletrrocerradura	2	2	2
04.MOT.013	Eletrrocerradura	1	1	1
04.MOT.014	Transformador	2	2	2
04.MOT.015	Transformador	1	1	1
04.MOT.016	Botonera	3	3	3
04.MOT.017	Gateway	3	3	3
04.AC.067	Kit Hoja Lateral	4	4	4
04.AC.082	Kit Hoja Central	4		
04.AC.083	Kit H.Central M.Inf. Oculto Tapas Aluminio		4	
04.AC.084	Kit H.Central M.Inf. Oculto Piso Corrido			4
04.AC.070	Tapa H.Lateral M.Inf. Oculto Tapas Aluminio		4	
04.AC.079	Tapa H.Lateral M.Inf. Oculto Piso Corrido			4
04.AC.071	Kit Cortavientos	2		
04.AC.080	Kit Cortavientos Marco Inferior Oculto		2	2
04.AC.085	Taco Estanq. M.Inf. Oculto Tapas Aluminio		2	
04.AC.086	Taco Estanq. M.Inf. Oculto Piso Corrido			2
04.AC.077	Kit Cierre Esquina Marco Inf. Oculto		1	1
04.AC.087	Cortavientos Hoja movil	2	2	2
04.TO.026	Tocho unión Marco Superior	8	8	8
04.ES.084	Escuadra Marco Esquina	4	4	4
04.AC.F10	Felpudo Marco Sup/Inf	16L	8L	16L
04.AC.F09	Felpudo Suplementos Hoja 16.349 y 16.651		4L	4L
04.JU.004.D	Junta Cierre Lateral	4H	4H	4H
04.JU.004.E	Junta Cierre 4 Hojas	2H	2H	2H
04.JU.062	Junta Cruce Central	4H	4H	4H
04.JU.067	Junta Cruce Central	4H	4H	4H
04.JU.068	Junta Tapa canal Marco	1mt	1mt	1mt
04.JU.069	Junta Carril	8L	8L	8L
04.AC.R150	Carril Acero Inox.	x4 x4	L-220 L-150	L-220 L-150
04.AC.R152	Rodamiento	8	8	8
04.AC.R153	Kit Angulo Rod. M.Inf. Oculto Tapas Aluminio		4	
04.AC.R154	Kit Angulo Rod. M.Inf. Oculto Piso Corrido			4
04.TA.070	Tapa para Canaleta	2	2	2
04.TA.071	Tapa para Solera	2	2	2
04.AC.073	Calzo Vidrio		Según dimensiones de Vidrio	

*Se indica la longitud total necesaria. Las tapas se colocan en tramos para permitir el montaje.

El perfil 16.651 se coloca deslizado en la hoja inferior en 2 trozos, para permitir sacar la hoja del marco en caso de necesidad una vez colocado el piso.

En caso de piso corrido las tapas que ocultan el marco inferior deben de ser registrables para permitir sacar las hojas en caso de necesidad.

BALCONERA EN ESQUINA ENTRANTE 2 HOJAS + 2 FIJOS

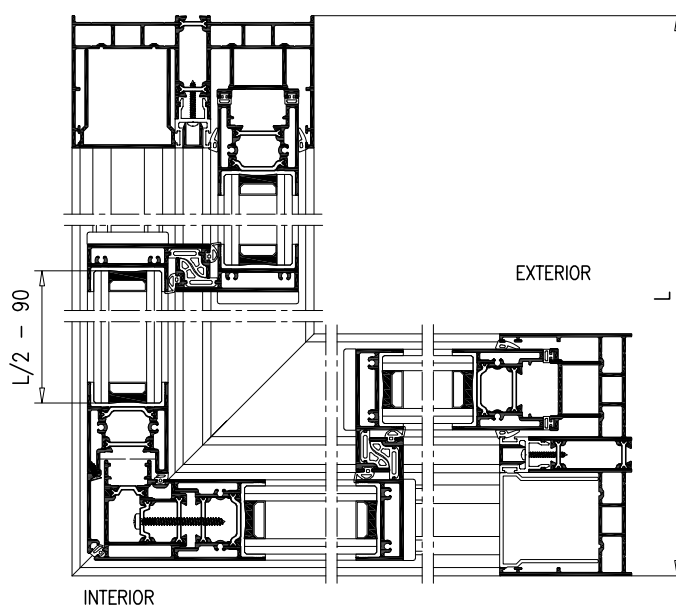
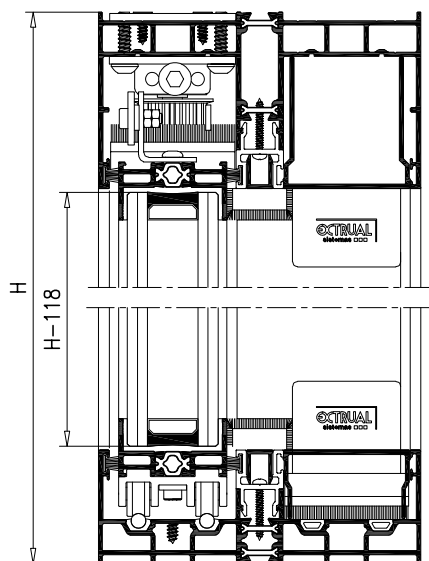

BALCONERA EN ESQUINA ENTRANTE 2 HOJAS + 2 FIJOS
Marco Interior Oculto Tapas de Aluminio

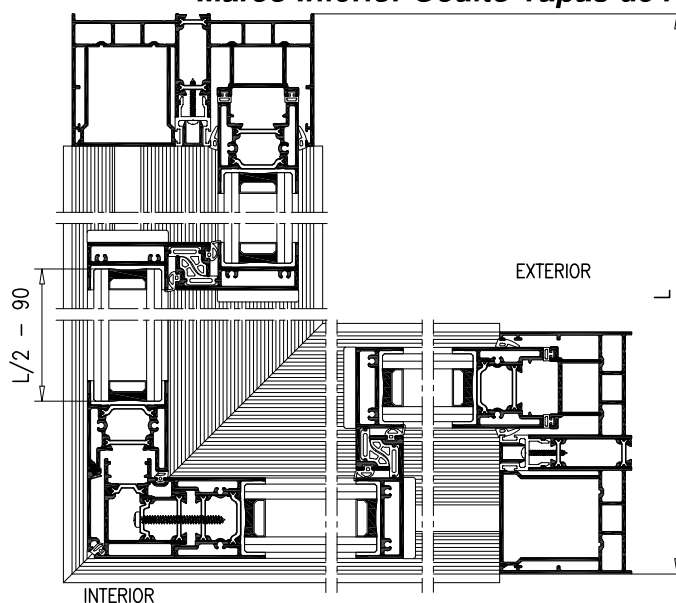
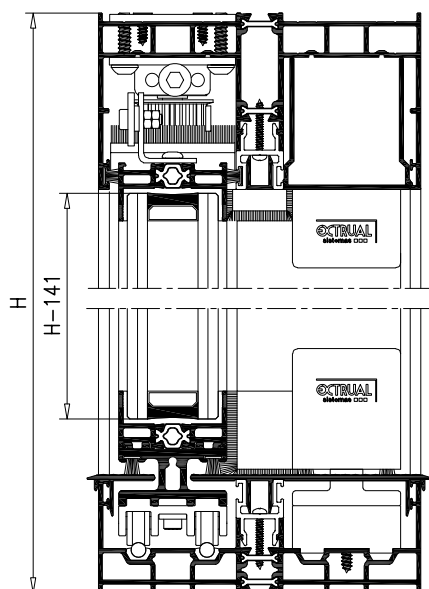



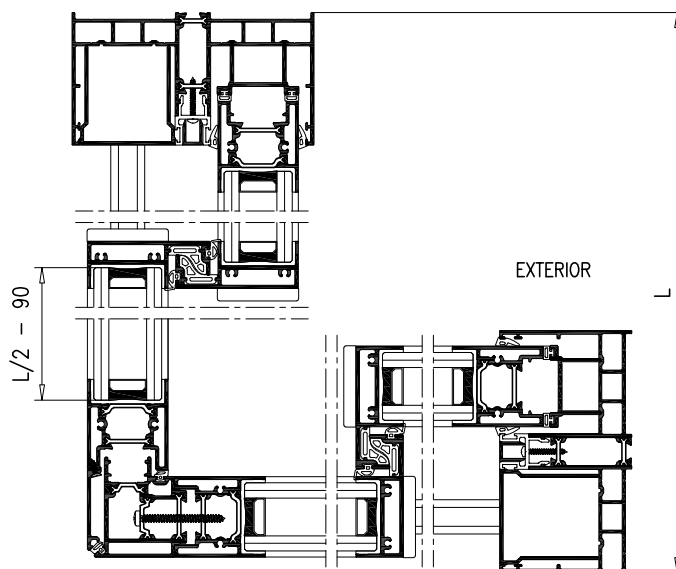
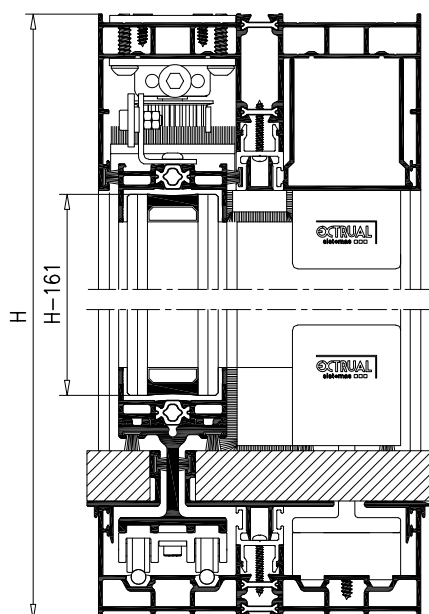





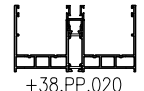
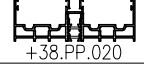











BALCONERA EN ESQUINA ENTRANTE 2 HOJAS + 2 FIJOS
Marco Interior Oculto Piso Corrido



BALCONERA EN ESQUINA ENTRANTE 2 HOJAS + 2 FIJOS

PERFILES

REFERENCIA	DENOMINACION	MARCO INFERIOR VISTO		MARCO INFERIOR OCULTO TAPAS ALUMINIO		MARCO INFERIOR OCULTO PISO CORRIDO		
		CANT.	CORTE	CANT.	CORTE	CANT.	CORTE	
R-954	 +38.PP.020	MARCO LAT/SUP	2	H	2	H	2	H
			1	L-70	1	L-70	1	L-70
R-941	 +38.PP.020	MARCO INFERIOR	1	L-70	1	L-70	1	L-70
R-943		HOJA LATERAL	4	H-140	4	H-163	4	H-183
R-945		HOJA SUP/INF	8	(L/2)-50	8	(L/2)-50	8	(L/2)-50
16.349		SUPLEMENT. HOJA			4	(L/2)-50		
16.651		SUPLEMENT. HOJA					8	(L/4)-25
16.347		HOJA DE CIERRE	4	H-140	4	H-163	4	H-183
R-947		HOJA ESQUINA	1	H-94	1	H-117	1	H-137
16.358		CIERRE ESQUINA	1	H-94	1	H-117	1	H-137
16.857		CIERRE LATERAL	2	H-75	2	H-114	2	H-134
16.342		TAPA CANAL	2	H-96	2	H-96	2	H-96
			4	(L/2)-68	2	(L/2)-68	2	(L/2)-68
			4	(L/2)-85	2	(L/2)-85	2	(L/2)-85
16.858		TAPA MARCO LAT/SUP	2	H-75	2	H-75	2	H-75
			2	(L/2)-83	2	(L/2)-83	2	(L/2)-83
16.343		TAPA MARCO INFERIOR	2	(L/2)-83				
16.344*		TAPA CENTRAL			2	(L/2)-56		
16.345*		TAPA LATERAL			2	(L/2)-56		
					2	L-66	2	(L/2)-119
16.346*		TAPA DOBLE			2	(L/2)-45		
16.652*		TAPA CENTRAL					2	(L/2)-56
16.653*		TAPA LATERAL					2	(L/2)-56
							2	L-66
16.654*		TAPA MULTIPLE					2	(L/2)-44
R-948		SOLERA	1	L-2	1	L-2	1	L-2
15.686		TAPA CANALETA	1	L-130	1	L-130		
16.351		CANALETA DRENAJE	1	L-128	1	L-128	1	L-128

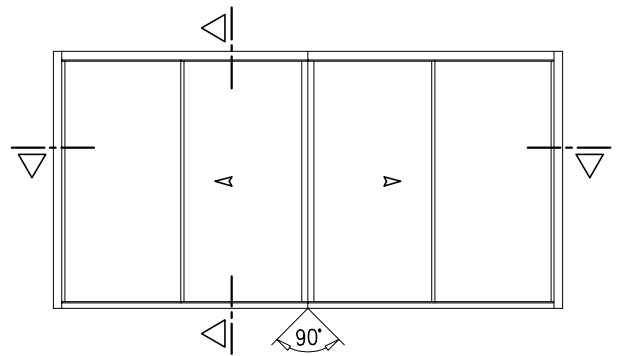

ACCESORIOS

REFERENCIA	DENOMINACION	M.INF. VISTO	M.INF. OCULTO TAPAS ALUMINIO	M.INF. OCULTO PISO CORRIDO
		UNIDADES	UNIDADES	UNIDADES
04.MOT.006	Kit Motor	2	2	2
04.MOT.009	Correa 14mts	1 6 2	1 6 2	1 6 2
04.MOT.010	Correa 30mts			
04.MOT.011	Conector Hoja	2	2	2
04.MOT.013	Eletrocerradura	1	1	1
04.MOT.015	Transformador	1	1	1
04.MOT.016	Botonera	1	1	1
04.MOT.017	Gateway	1	1	1
04.AC.067	Kit Hoja Lateral	4	4	4
04.AC.082	Kit Hoja Central	4		
04.AC.083	Kit H.Central M.Inf. Oculto Tapas Aluminio		4	
04.AC.084	Kit H.Central M.Inf. Oculto Piso Corrido			4
04.AC.070	Tapa H.Lateral M.Inf. Oculto Tapas Aluminio		4	
04.AC.079	Tapa H.Lateral M.Inf. Oculto Piso Corrido			4
04.AC.071	Kit Cortavientos	2		
04.AC.080	Kit Cortavientos Marco Inferior Oculto		2	2
04.AC.085	Taco Estanq. M.Inf. Oculto Tapas Aluminio		2	
04.AC.086	Taco Estanq. M.Inf. Oculto Piso Corrido			2
04.AC.077	Kit Cierre Esquina Marco Inf. Oculto		1	1
04.AC.087	Cortavientos Hoja movil	2	2	2
04.TO.026	Tocho unión Marco Superior	8	8	8
04.ES.084	Escuadra Marco Esquina	4	4	4
04.AC.F10	Felpudo Marco Sup/Inf	8L	4L	8L
04.AC.F09	Felpudo Suplementos Hoja 16.349 y 16.651		2L	2L
04.JU.004.D	Junta Cierre Lateral	4H	4H	4H
04.JU.004.E	Junta Cierre 4 Hojas	2H	2H	2H
04.JU.062	Junta Cruce Central	4H	4H	4H
04.JU.067	Junta Cruce Central	4H	4H	4H
04.JU.068	Junta Tapacanal Marco	4L	4L	4L
04.JU.069	Junta Carril	4L	4L	4L
04.AC.R150	Carril Acero Inox.	x4	L-150	L-150
04.AC.R152	Rodamiento	4	4	4
04.AC.R153	Kit Angulo Rod. M.Inf. Oculto Tapas Aluminio		2	
04.AC.R154	Kit Angulo Rod. M.Inf. Oculto Piso Corrido			2
04.AC.074	Calzo Hoja Fija	4	4	4
04.JA.004	Junta Hoja Fija	4L+4H	4L+4H	4L+4H
04.TA.070	Tapa para Canaleta	2	2	2
04.TA.071	Tapa para Solera	2	2	2
04.AC.073	Calzo Vidrio	Según dimensiones de Vidrio		

*Se indica la longitud total necesaria. Las tapas se colocan en tramos para permitir el montaje.

El perfil 16.651 se coloca deslizado en la hoja inferior en 2 trozos, para permitir sacar la hoja del marco en caso de necesidad una vez colocado el piso.

En caso de piso corrido las tapas que ocultan el marco inferior deben de ser registrables para permitir sacar las hojas en caso de necesidad.

BALCONERA EN ESQUINA ENTRANTE 2 HOJAS + 2 HOJAS

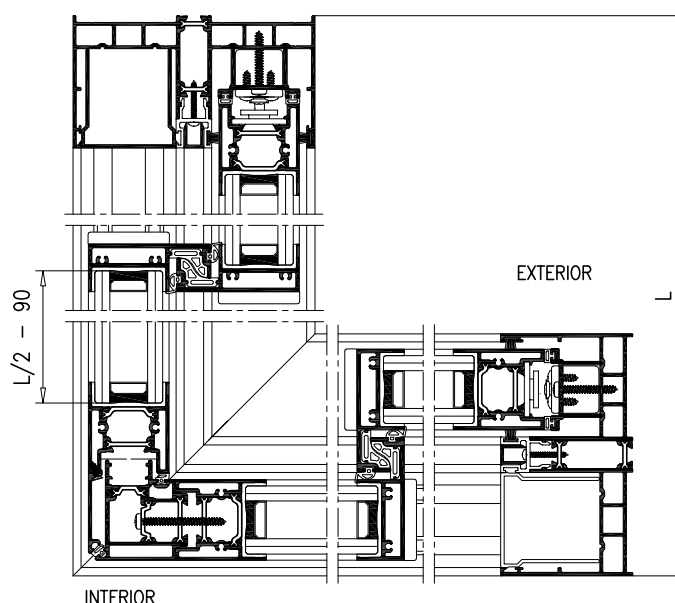
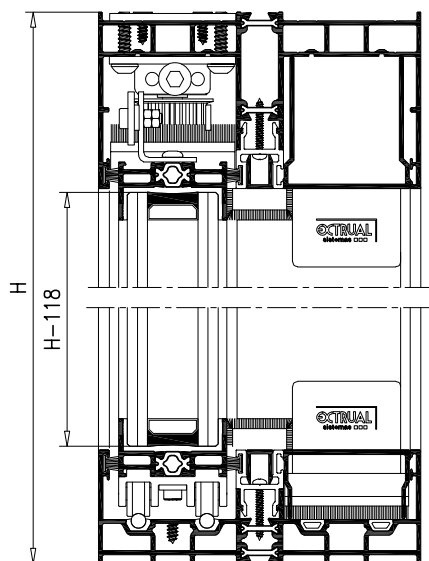

BALCONERA EN ESQUINA ENTRANTE 2 HOJAS + 2 HOJAS
Marco Interior Oculto Tapas de Aluminio

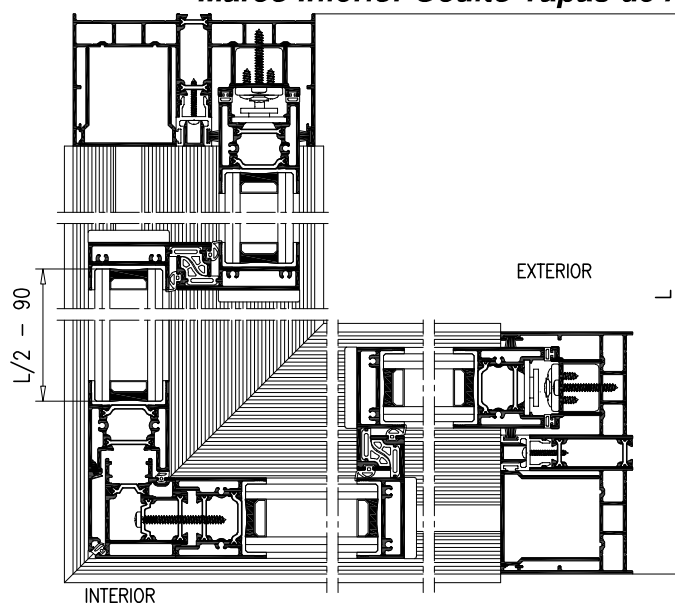
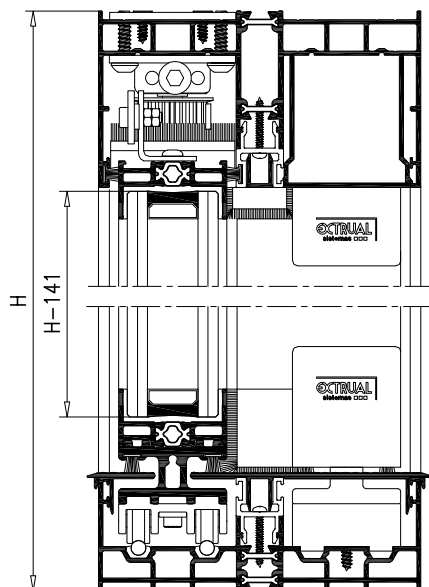



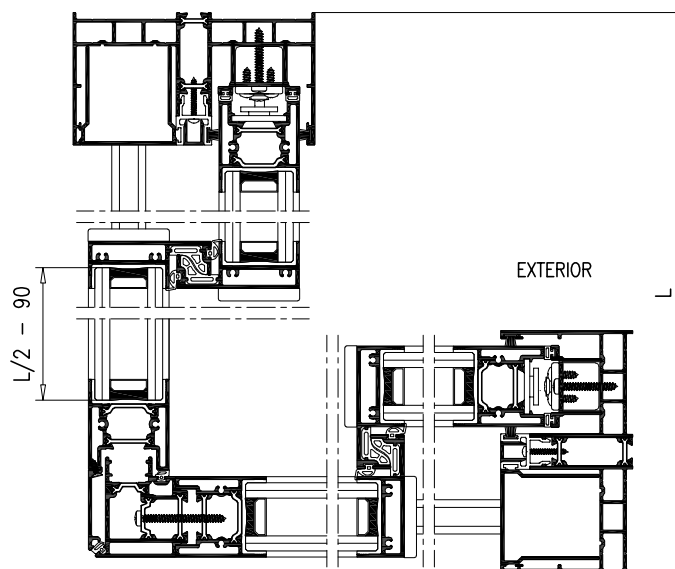
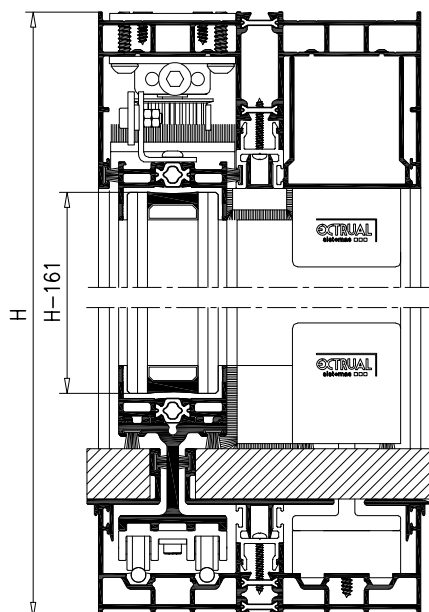



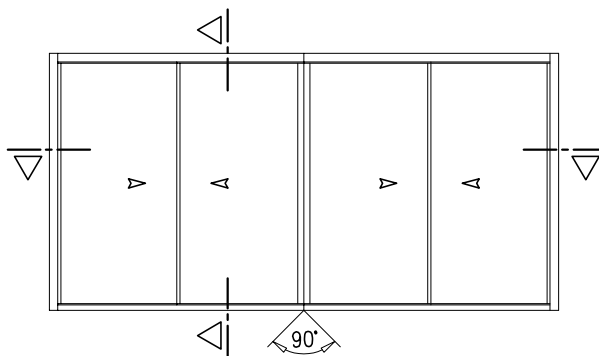



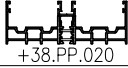





BALCONERA EN ESQUINA ENTRANTE 2 HOJAS + 2 HOJAS
Marco Interior Oculto Piso Corrido



BALCONERA EN ESQUINA ENTRANTE 2 HOJAS + 2 HOJAS

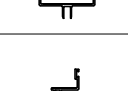

PERFILES

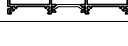
REFERENCIA	DENOMINACION	MARCO INFERIOR VISTO		MARCO INFERIOR OCULTO TAPAS ALUMINIO		MARCO INFERIOR OCULTO PISO CORRIDO	
		CANT.	CORTE	CANT.	CORTE	CANT.	CORTE
R-954	MARCO LAT/SUP  +38.PP.020	2 1	H L-70	2 1	H L-70	2 1	H L-70
R-941	MARCO INFERIOR  +38.PP.020	1	L-70	1	L-70	1	L-70
R-943	HOJA LATERAL 	4	H-140	4	H-163	4	H-183
R-945	HOJA SUP/INF 	8	(L/2)-50	8	(L/2)-50	8	(L/2)-50
16.349	SUPLEMENT. HOJA 			4	(L/2)-50		
16.651	SUPLEMENT. HOJA 					8	(L/4)-25
16.347	HOJA DE CIERRE 	4	H-140	4	H-163	4	H-183
R-947	HOJA ESQUINA 	1	H-94	1	H-117	1	H-137
16.358	CIERRE ESQUINA 	1	H-94	1	H-117	1	H-137
16.857	CIERRE LATERAL 	2	H-75	2	H-114	2	H-134
16.342	TAPA CANAL 	2 4 4	H-96 (L/2)-68 (L/2)-85	2 2 2	H-96 (L/2)-68 (L/2)-85	2 2 2	H-96 (L/2)-68 (L/2)-85
16.858	TAPA MARCO LAT/SUP 	2	H-75	2	H-75	2	H-75
16.344*	TAPA CENTRAL 			2	L-106		
16.345*	TAPA LATERAL 			2 2	L-175 L-66		
16.652*	TAPA CENTRAL 					2	L-104
16.653*	TAPA LATERAL 					2 2	L-173 L-66
R-948	SOLERA 	1	L-2	1	L-2	1	L-2
15.686	TAPA CANALETA 	1	L-130	1	L-130		
16.351	CANALETA DRENAJE 	1	L-128	1	L-128	1	L-128

*Se indica la longitud total necesaria. Las tapas se colocan en tramos para permitir el montaje.

El perfil 16.651 se coloca deslizado en la hoja inferior en 2 trozos, para permitir sacar la hoja del marco en caso de necesidad una vez colocado el piso.

ACCESORIOS

REFERENCIA	DENOMINACION	M.INF. VISTO	M.INF. OCULTO TAPAS ALUMINIO	M.INF. OCULTO PISO CORRIDO
		UNIDADES	UNIDADES	UNIDADES
04.MOT.006	Kit Motor	4	4	4
04.MOT.009	Correa 14mts	2 6 4	2 6 4	2 6 4
04.MOT.010	Correa 30mts			
04.MOT.011	Conector Hoja	4	4	4
04.MOT.012	Electrocerradura	2	2	2
04.MOT.013	Electrocerradura	1	1	1
04.MOT.014	Transformador	2	2	2
04.MOT.015	Transformador	1	1	1
04.MOT.016	Botonera	3	3	3
04.MOT.017	Gateway	3	3	3
04.AC.067	Kit Hoja Lateral	4	4	4
04.AC.082	Kit Hoja Central	4		
04.AC.083	Kit H.Central M.Inf. Oculto Tapas Aluminio		4	
04.AC.084	Kit H.Central M.Inf. Oculto Piso Corrido			4
04.AC.070	Tapa H.Lateral M.Inf. Oculto Tapas Aluminio		4	
04.AC.079	Tapa H.Lateral M.Inf. Oculto Piso Corrido			4
04.AC.071	Kit Cortavientos	2		
04.AC.080	Kit Cortavientos Marco Inferior Oculto		2	2
04.AC.085	Taco Estanq. M.Inf. Oculto Tapas Aluminio		2	
04.AC.086	Taco Estanq. M.Inf. Oculto Piso Corrido			2
04.AC.077	Kit Cierre Esquina Marco Inf. Oculto		1	1
04.AC.087	Cortavientos Hoja movil	2	2	2
04.TO.026	Tocho unión Marco Superior	8	8	8
04.ES.084	Escuadra Marco Esquina	4	4	4
04.AC.F10	Felpudo Marco Sup/Inf	16L	8L	16L
04.AC.F09	Felpudo Suplementos Hoja 16.349 y 16.651		4L	4L
04.JU.004.D	Junta Cierre Lateral	4H	4H	4H
04.JU.004.E	Junta Cierre 4 Hojas	2H	2H	2H
04.JU.062	Junta Cruce Central	4H	4H	4H
04.JU.067	Junta Cruce Central	4H	4H	4H
04.JU.068	Junta Tapacanal Marco	4L	4L	4L
04.JU.069	Junta Carril	1mt	1mt	1mt
04.AC.R150	Carril Acero Inox.	x4 x4	L-220 L-150	L-220 L-150
04.AC.R152	Rodamiento	8	8	8
04.AC.R153	Kit Angulo Rod. M.Inf. Oculto Tapas Aluminio		4	
04.AC.R154	Kit Angulo Rod. M.Inf. Oculto Piso Corrido			4
04.TA.070	Tapa para Canaleta	2	2	2
04.TA.071	Tapa para Solera	2	2	2
04.AC.073	Calzo Vidrio		Según dimensiones de Vidrio	

En caso de piso corrido las tapas que ocultan el marco inferior deben de ser registrables para permitir sacar las hojas en caso de necesidad.

MECANIZADO PARA LA UNION DE MARCOS A 90° CON CORTE EN RECTO con Tocho 04.TO.026

El mecanizado de los Marcos R-941, R-943, R-954 y R-955 se realiza con el troquel 04.TRO.E150

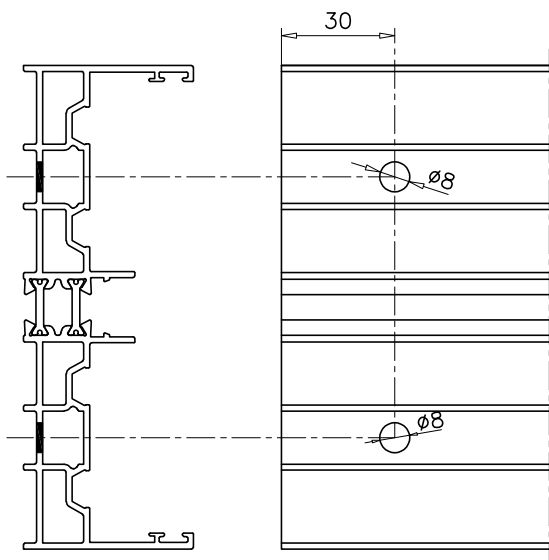

MECANIZADO MARCO SUPERIOR (R-954)/INFERIOR (R-941)

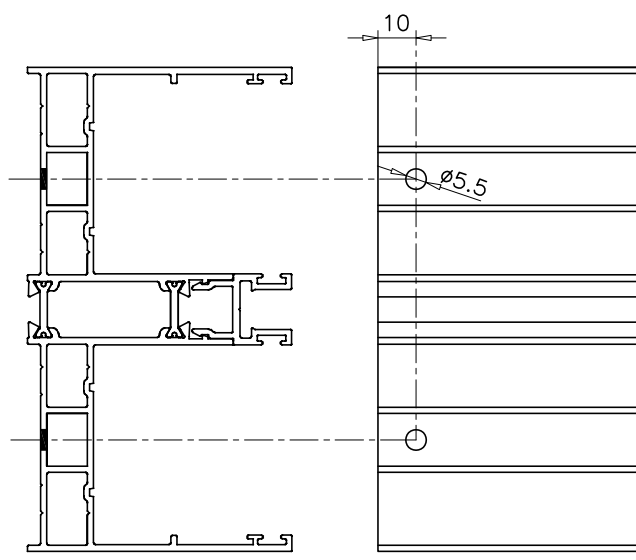

MECANIZADO MARCOS LATERALES (R-954)

Es necesario rebajar las aletas 70mm en los extremos de la Solera para el correcto asiento del Marco sobre ella

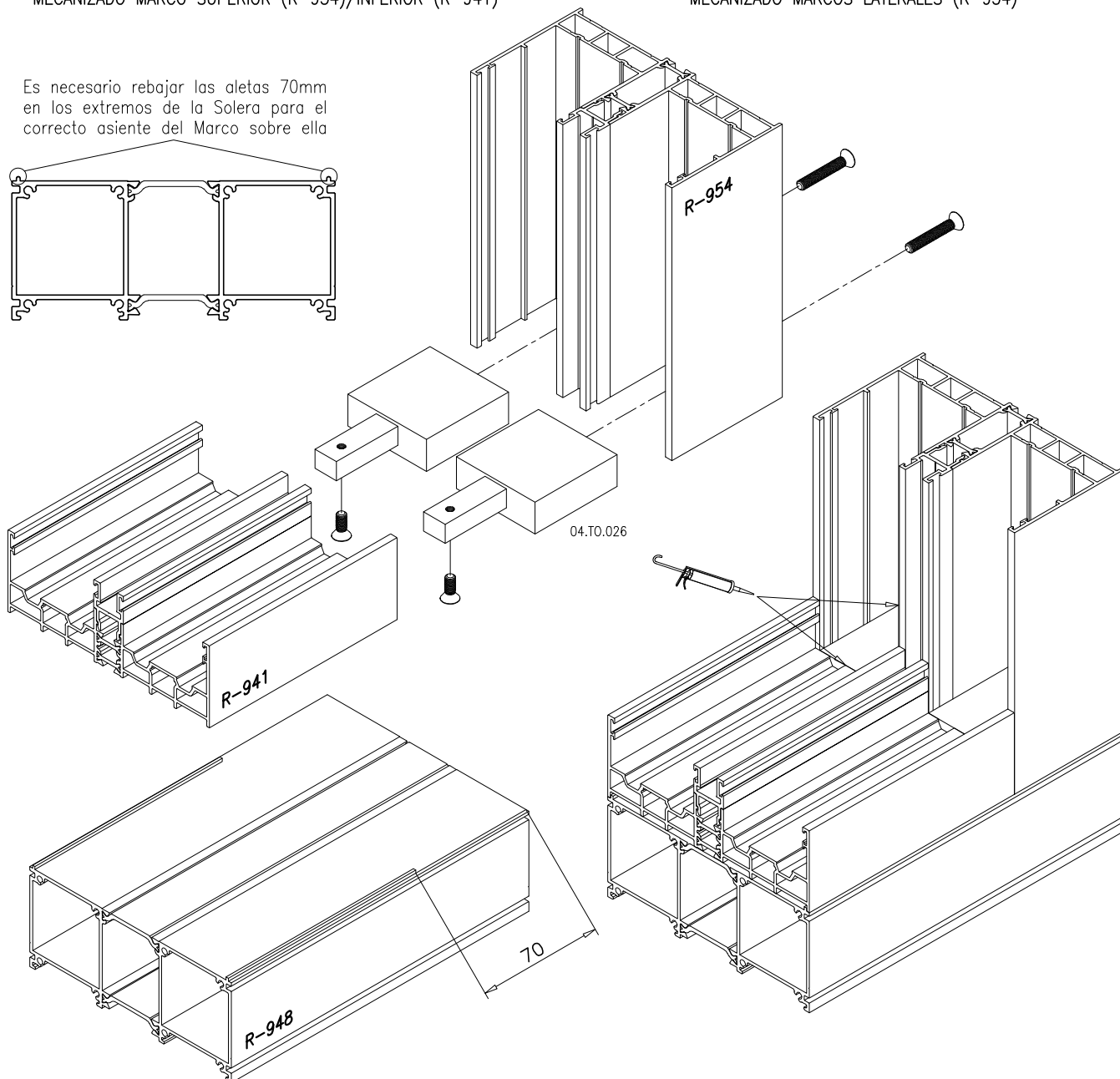
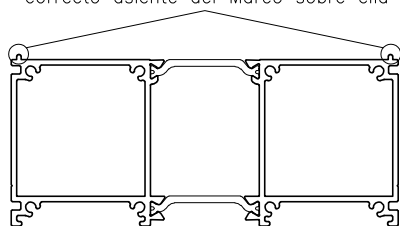

INSTALACION DEL SISTEMA DE MOTORIZACION EN EL MARCO

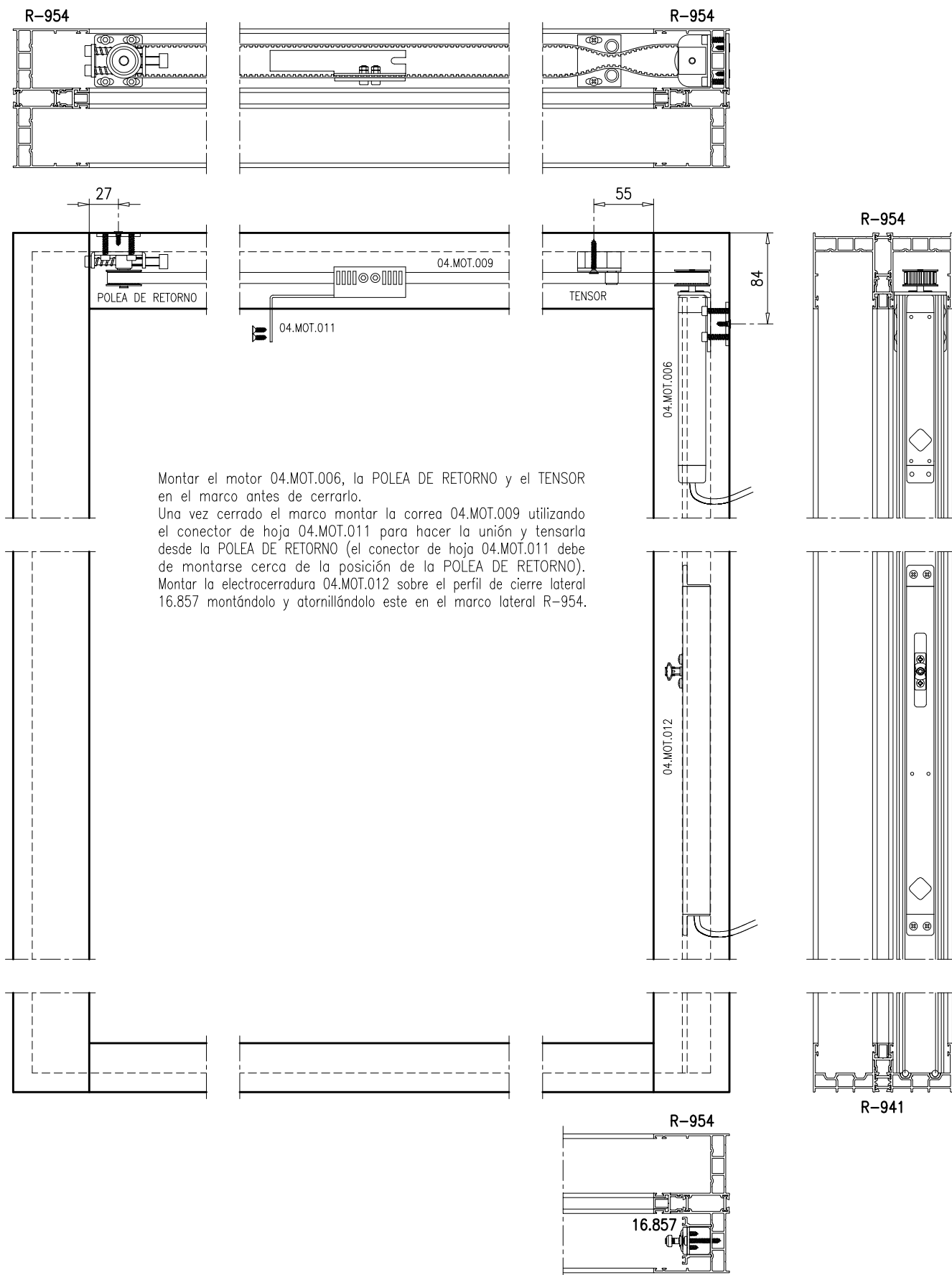

INSTALACION DEL MOTOR EN EL MARCO LATERAL

El motor cuenta con sistema antiplastamiento y bloqueo automático por lo que el uso de electroerradura es opcional. Se recomienda la instalación de una batería de seguridad de 24V.

Una vez fijada la contraplaca en la parte posterior del marco se monta frontalmente el motor con tornillos de métrica, esto permite regular su posición o cambiarlo en caso de necesidad.

Hacer un taladro pasante en el marco para llevar el cable del motor a la caja de conexiones.

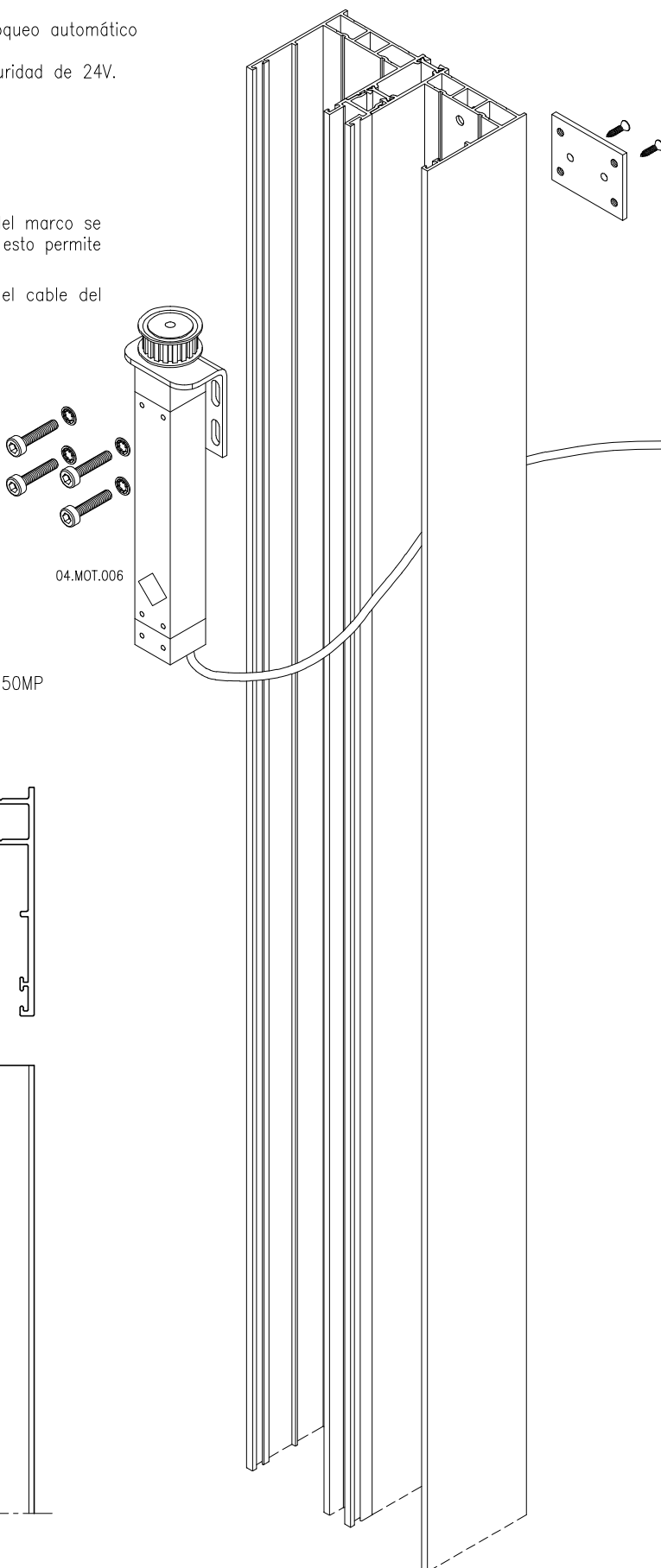

04.MOT.006

El mecanizado se realiza con la Plantilla 04.TRO.E150MP

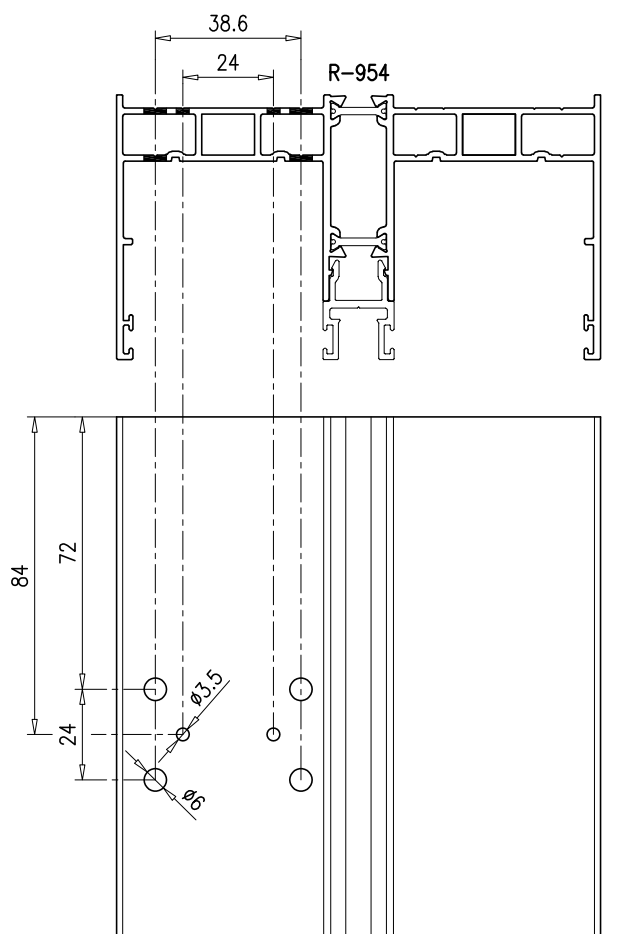

INSTALACION DEL MOTOR EN EL MARCO LATERAL
En el lado del cierre de la Hoja

El mecanizado se realiza con el Troquel 04.TRO.E150M

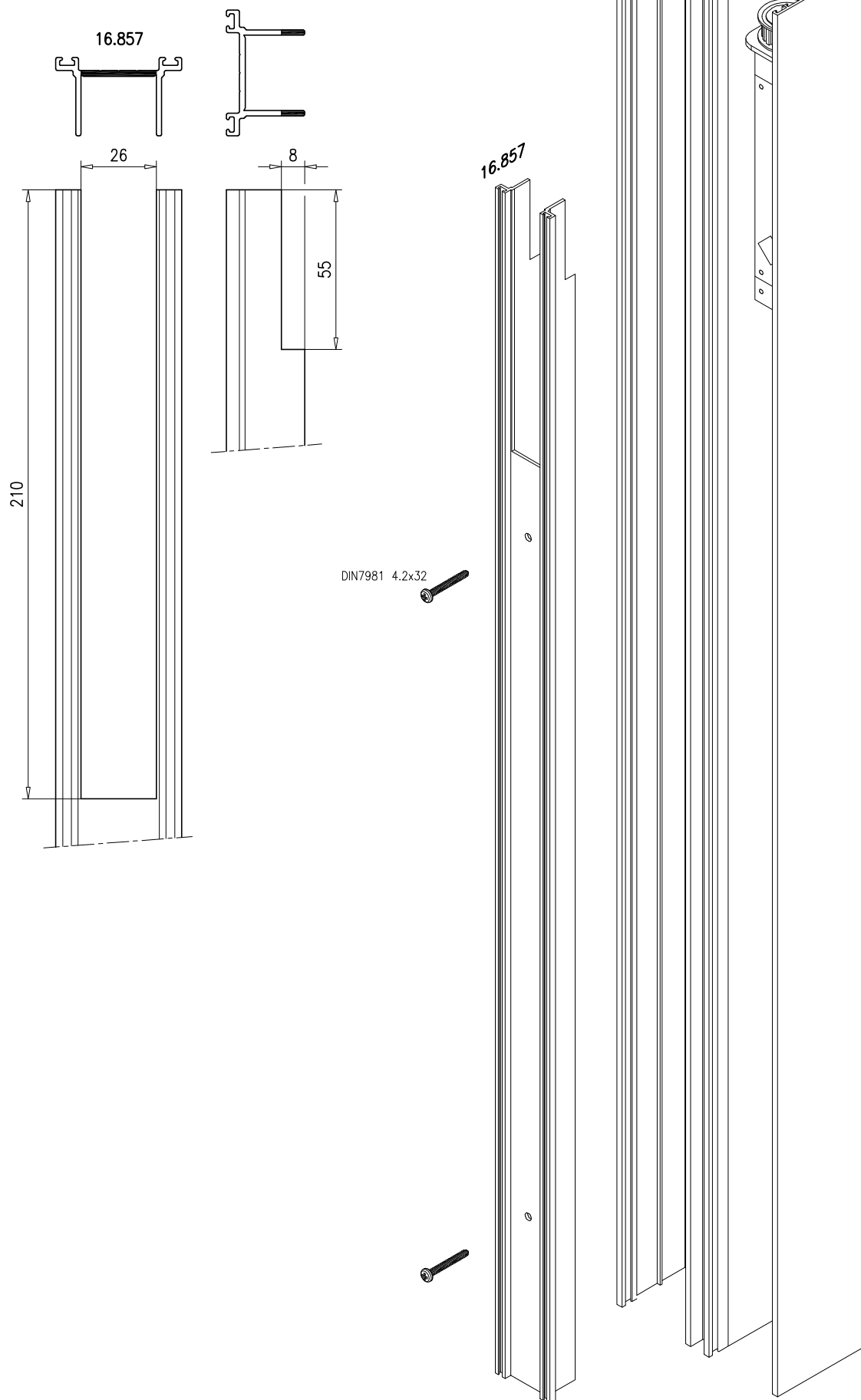

INSTALACION DEL MOTOR EN EL MARCO LATERAL
En el lado opuesto al cierre de la Hoja y en carriles centrales en marcos de 3 y 4 carriles

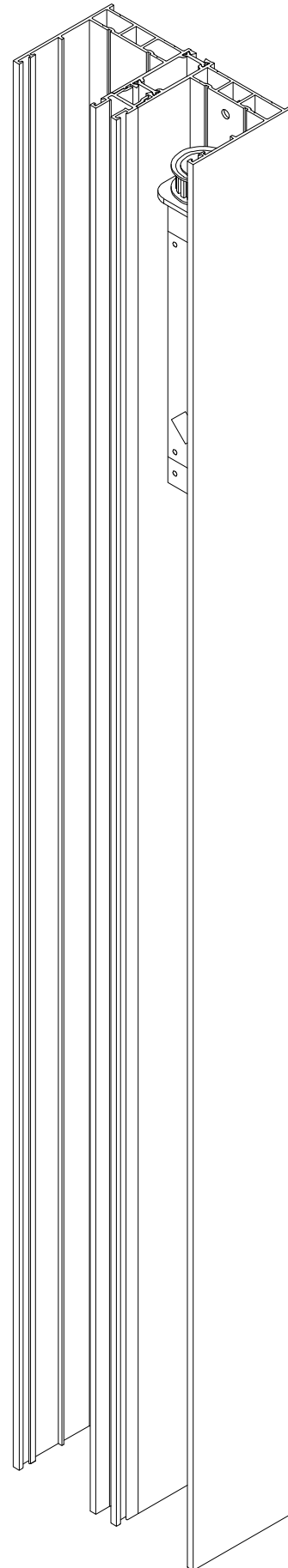
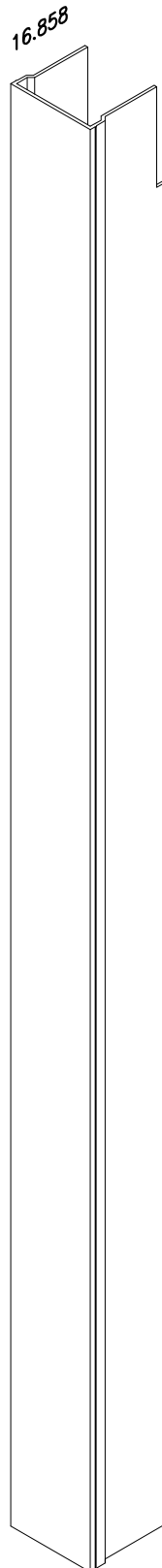
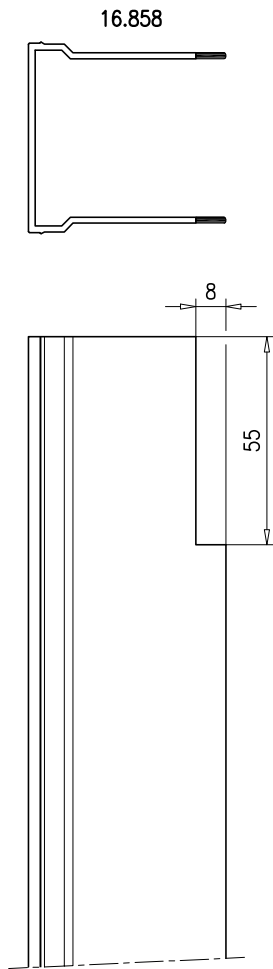

INSTALACION DE LA POLEA DE RETORNO EN EL MARCO SUPERIOR 2 CARRILES

El mecanizado se realiza con la Plantilla 04.TRO.E150MP

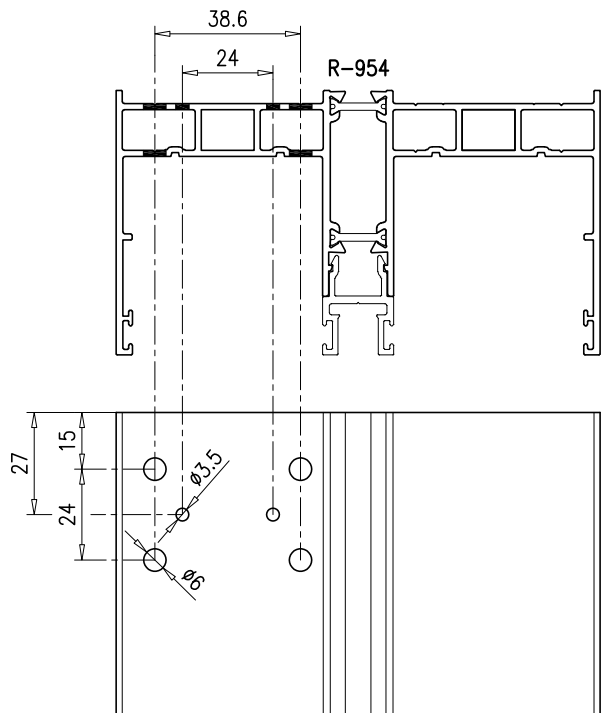

En marcos de 3 y 4 carriles la polea puede instalarse en cualquier posición que permita el movimiento de la Hoja.

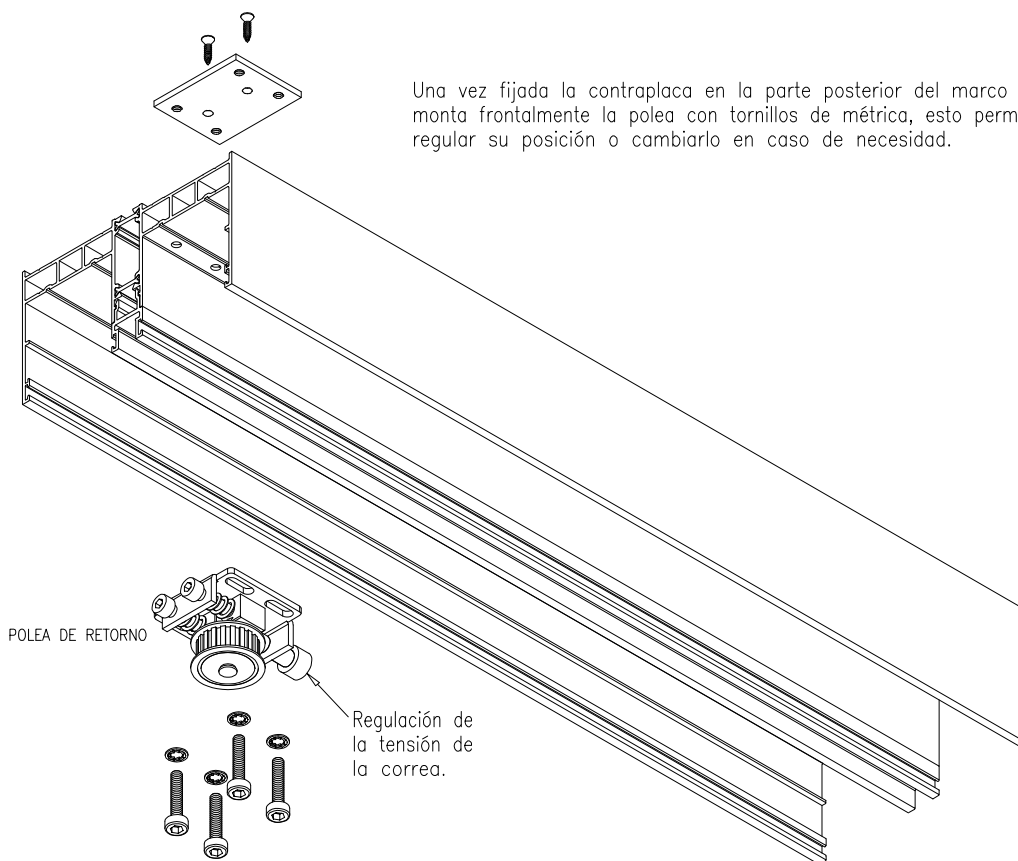

Una vez fijada la contraplaca en la parte posterior del marco se monta frontalmente la polea con tornillos de métrica, esto permite regular su posición o cambiarlo en caso de necesidad.

INSTALACION DE LA ELECTROCERRADURA
Cierre en Hoja Lateral

16.857

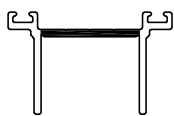

El mecanizado se realiza con el Troquel 04.TRO.E150M

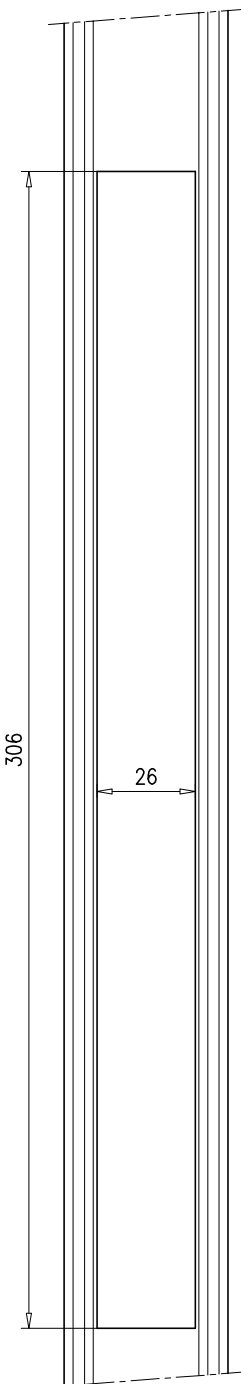

16.857

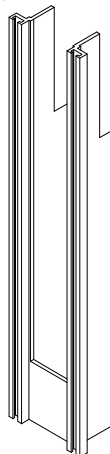

DIN7981 4.2x32

DIN7981 3.9x13



IMPORTANTE:

Deslizar el cerradero en la hoja lateral R-943 antes de ensamblar y acristalar la hoja.

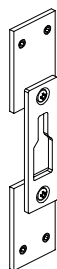

04.MOT.012

DESBLOQUEO ELECTROCERRADURA

Si se produce un corte de corriente la electrocerradura se puede desbloquear con la llave 04.MOT.018, hay que realizar un taladro de 10mm en el perfil de cierre 16.857 y en el marco R-954 para tener acceso al punto de desbloqueo. Si el marco esta oculto en obra será necesario realizar un registro, si el marco es visto colocar una tapa 04.TA.010 en el taladro del marco.

ESTO NO SERA NECESARIO SI SE INSTALA UNA BATERIA DE 24V DE SEGURIDAD.

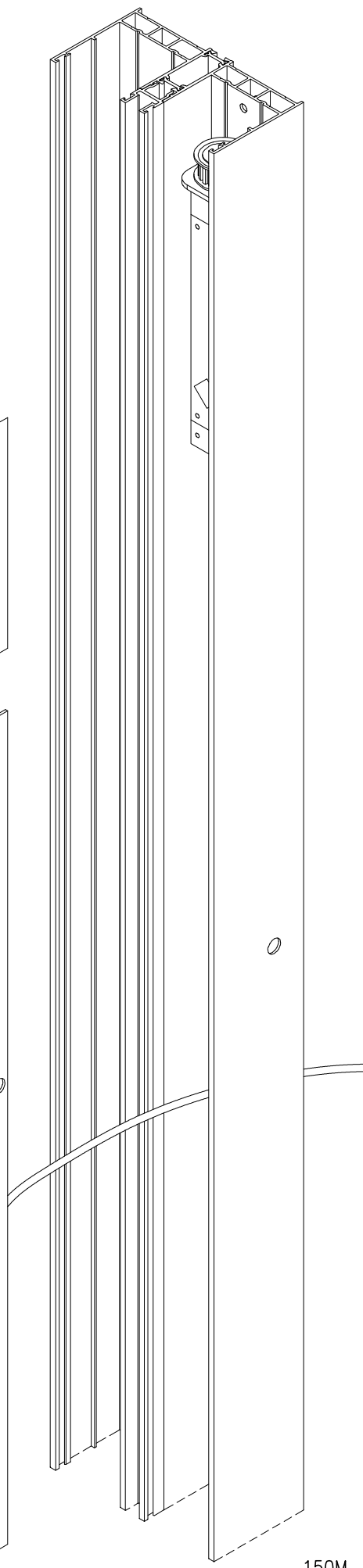

INSTALACION DE LA ELECTROCERRADURA Cierre en Hojas Centrales (4 hojas)

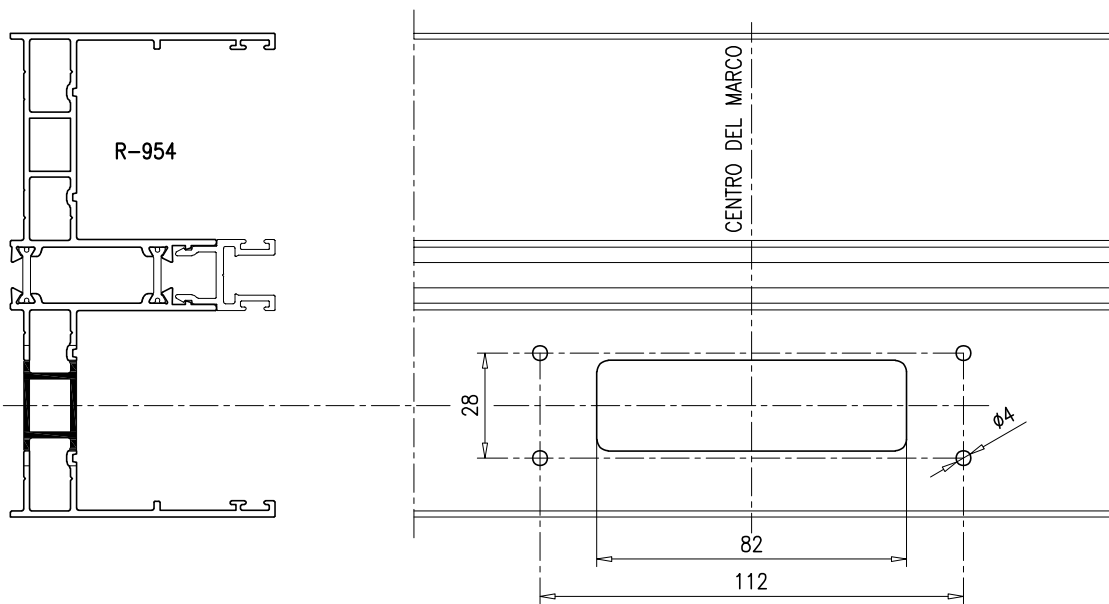

Para el desbloqueo de la electrocerradura en caso de corte de corriente se recomienda la instalación de una batería de seguridad de 24V.

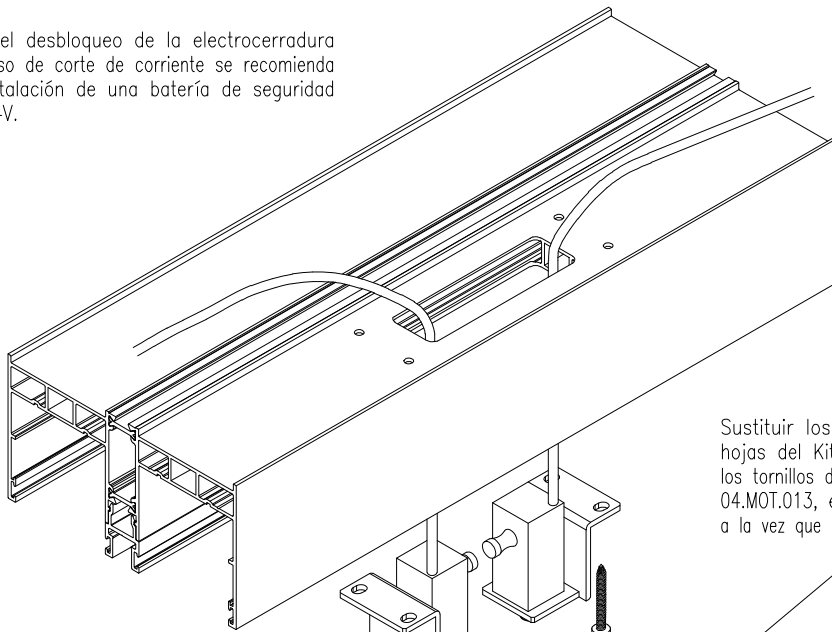

Sustituir los tornillos para la unión de las hojas del Kit de Hoja Lateral 04.AC.067 por los tornillos del cerradero de la electrocerradura 04.MOT.013, estos tornillos sujetan el cerradero a la vez que unen la Hoja Superior con la Lateral.

Utilizando el cerradero como plantilla profundizar 3mm en la hoja Superior con una broca de 10mm.

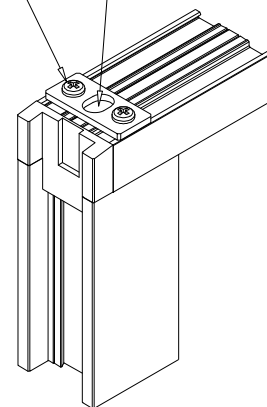

INSTALACION DE LA ELECTROCERRADURA Cierre en Esquina

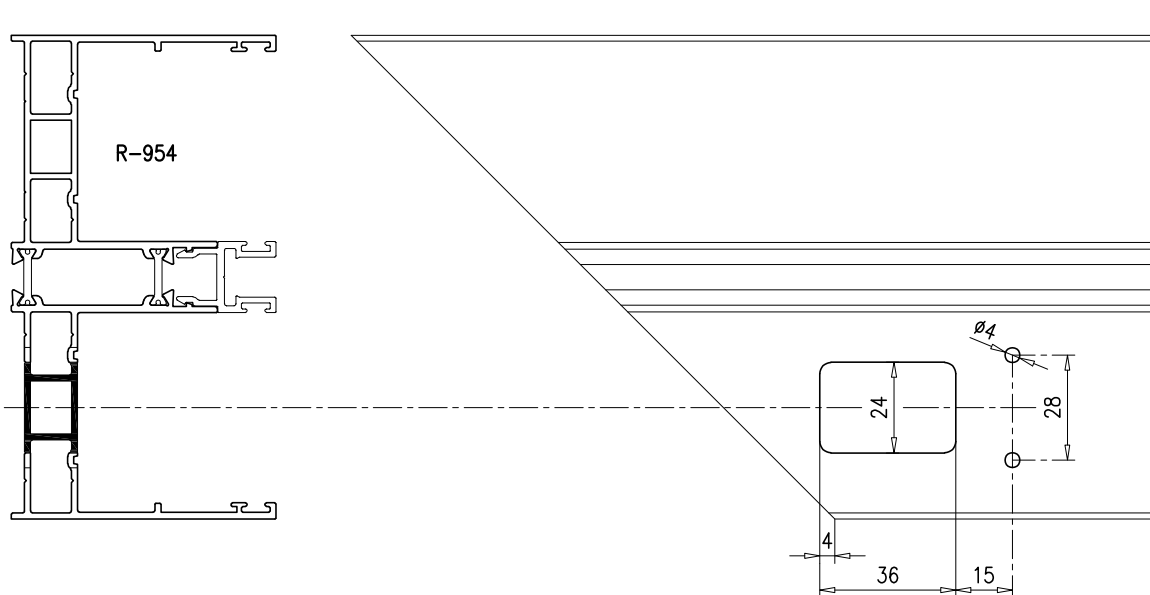

Para el desbloqueo de la electrocerradura en caso de corte de corriente se recomienda la instalación de una batería de seguridad de 24V.

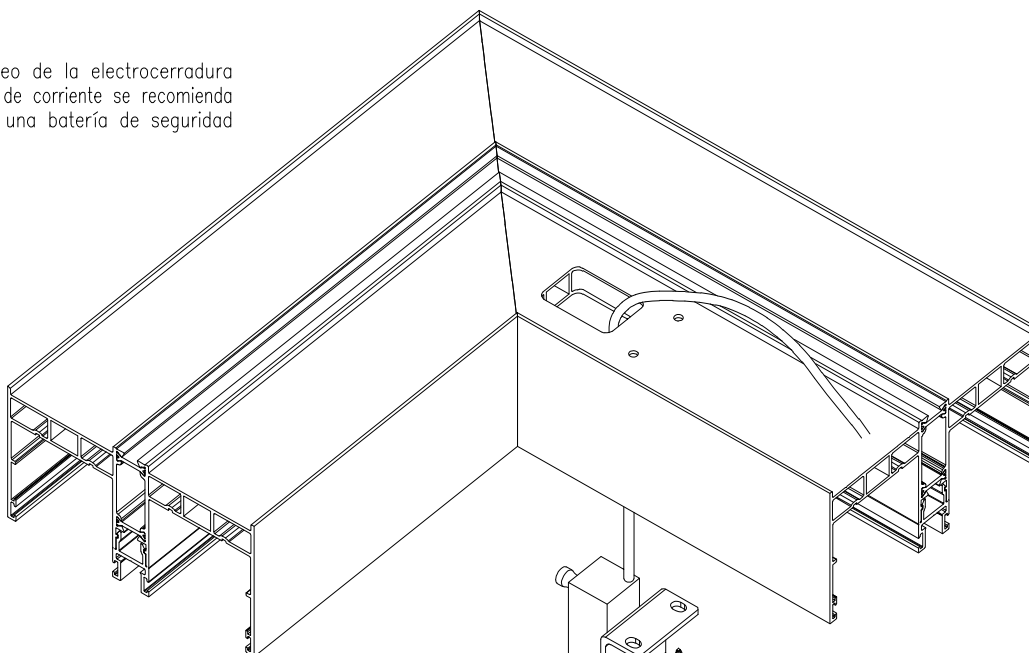

Sustituir los tornillos para la unión de las hojas del Kit de Hoja Lateral 04.AC.067 por los tornillos del cerradero de la electrocerradura 04.MOT.013, estos tornillos sujetan el cerradero a la vez que unen la Hoja Superior con la Lateral.

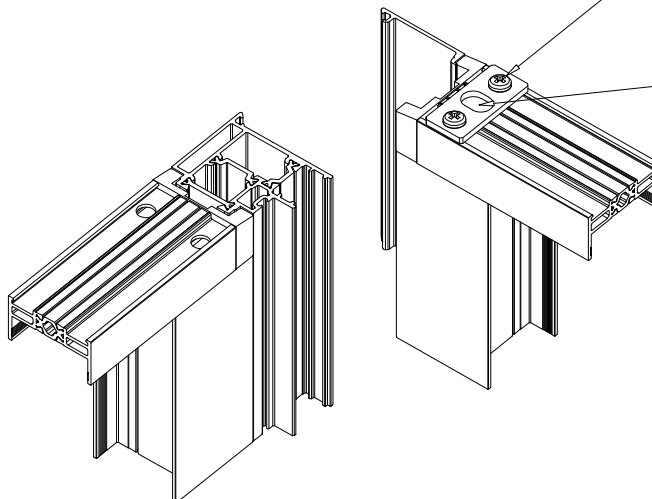

Utilizando el cerradero como plantilla profundizar 3mm en la hoja Superior con una broca de 10mm.

FIJACION DEL CONECTOR A LA HOJA Y CONEXION DE LA CADENA A LA HOJA



Utilizar el conector como plantilla para colocar el tornillo especial sobre la hoja.

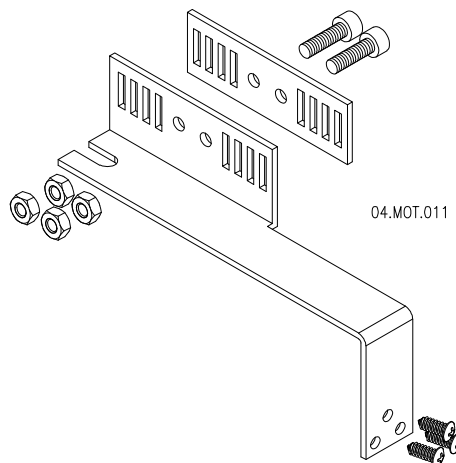
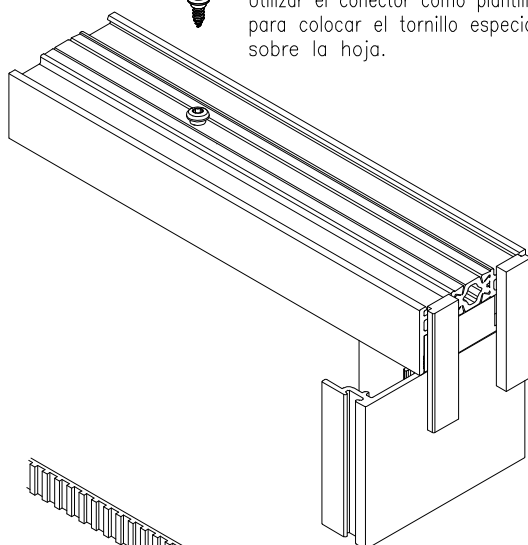

04.MOT.011

Una vez colocada la hoja en el marco se lleva hasta la posición del conector y este se desliza en el tornillo especial y posteriormente se fija lateralmente con 3 tornillos a la hoja.

El tornillo especial evita que el conector se levante cuando la correa tira de la hoja.

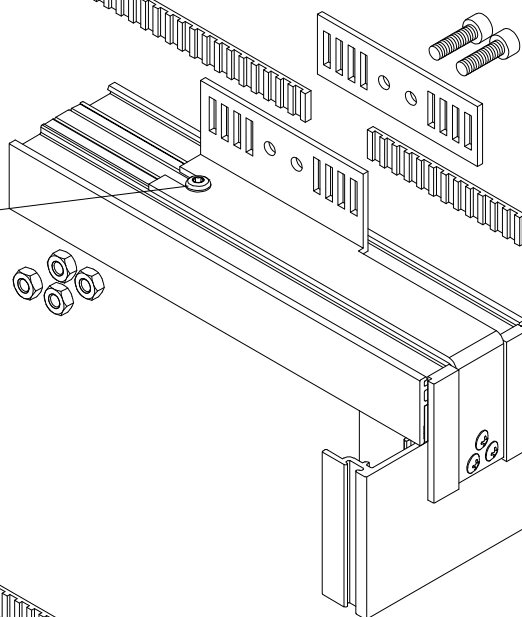

04.MOT.009
04.MOT.010

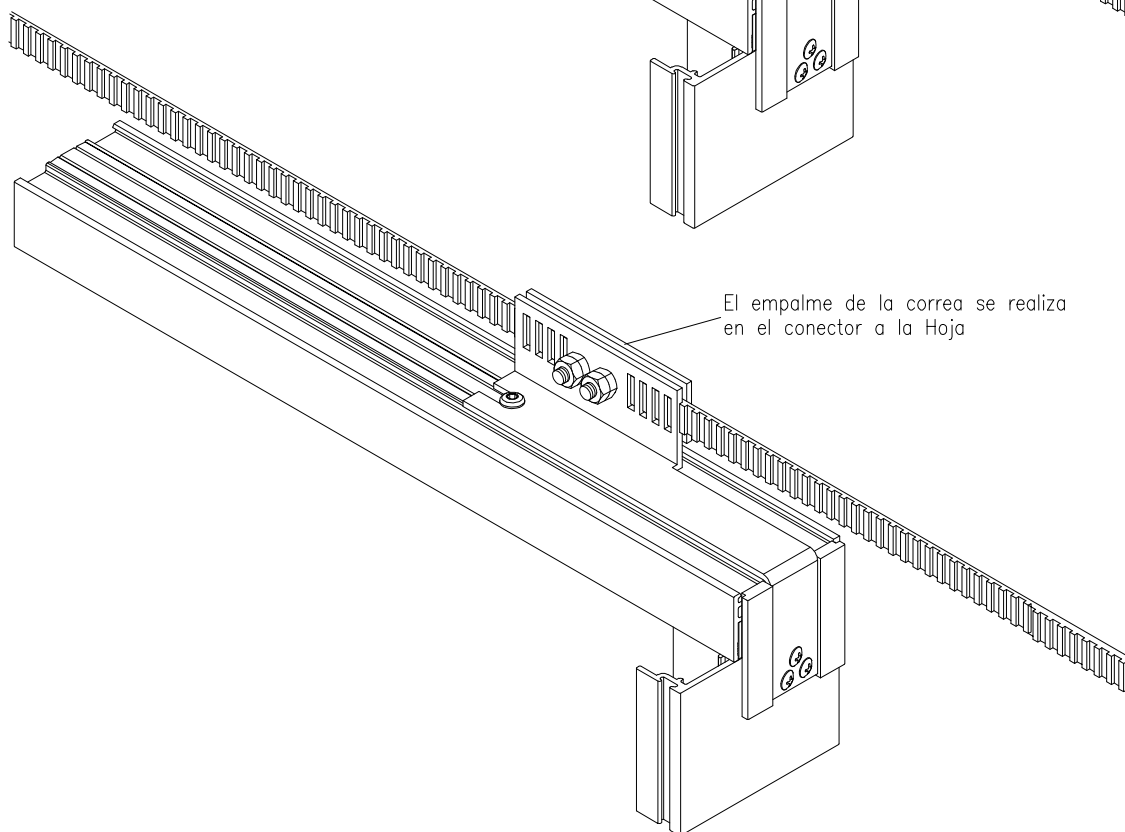

El empalme de la correa se realiza en el conector a la Hoja

MONTAJE DE LA HOJA EN EL MARCO

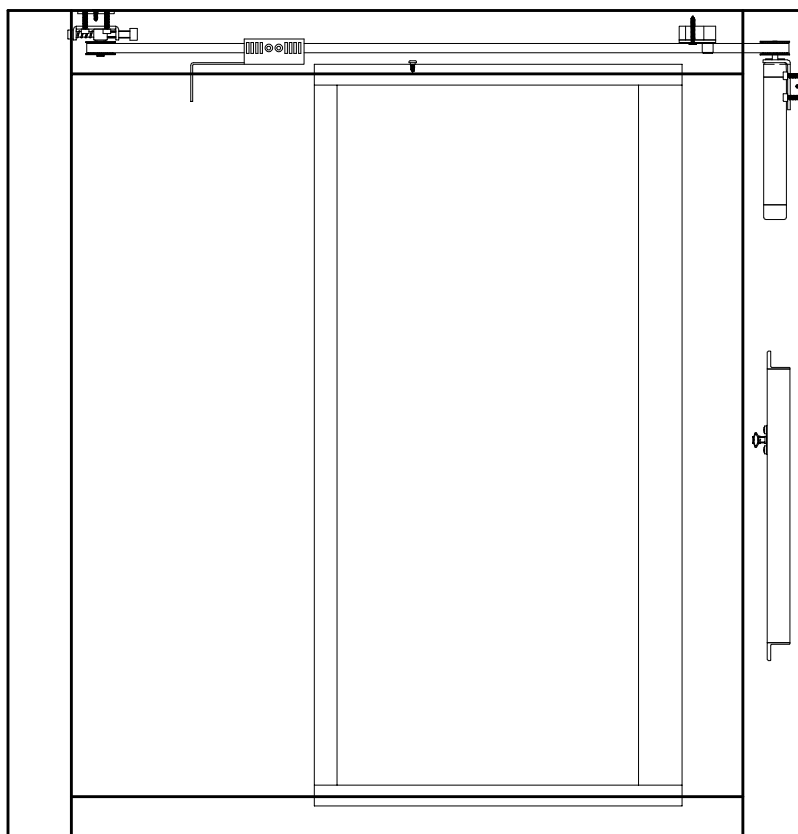

Con el conector de hoja instalado cerca de la polea de retorno colocar la hoja en el marco

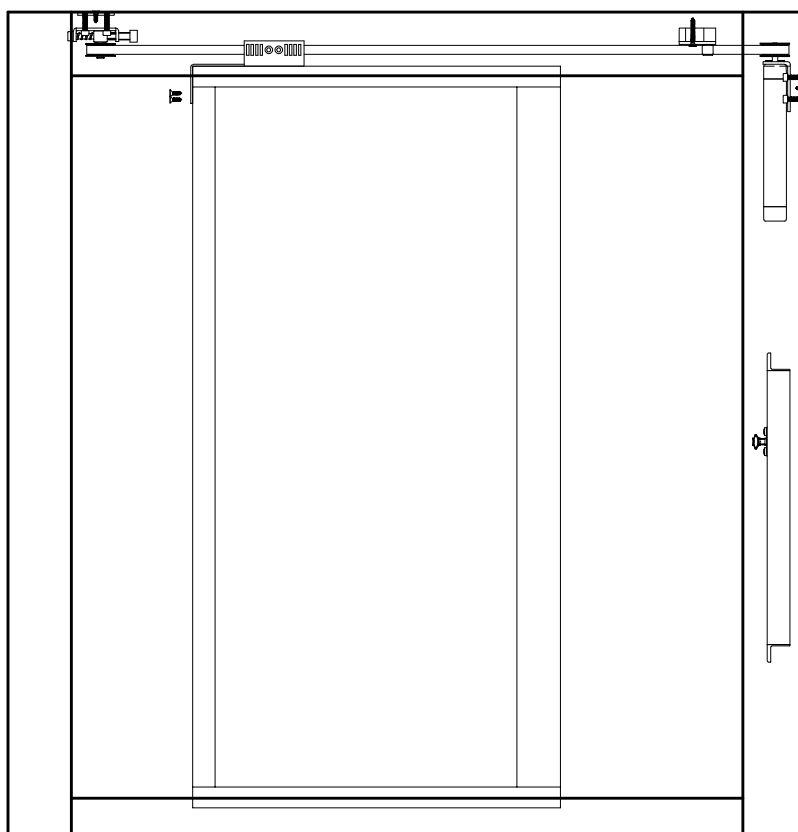

Mover la hoja hasta el conector asegurando que este se desliza sobre el tornillo especial montado en la hoja y fijar el conector a la hoja con los 3 tornillos

CONEXIÓN ELÉCTRICA DE 1 MOTOR Y ELECTROCERRADURA

RECOMENDACION: Instalar una batería 24V de seguridad para el caso de corte de corriente

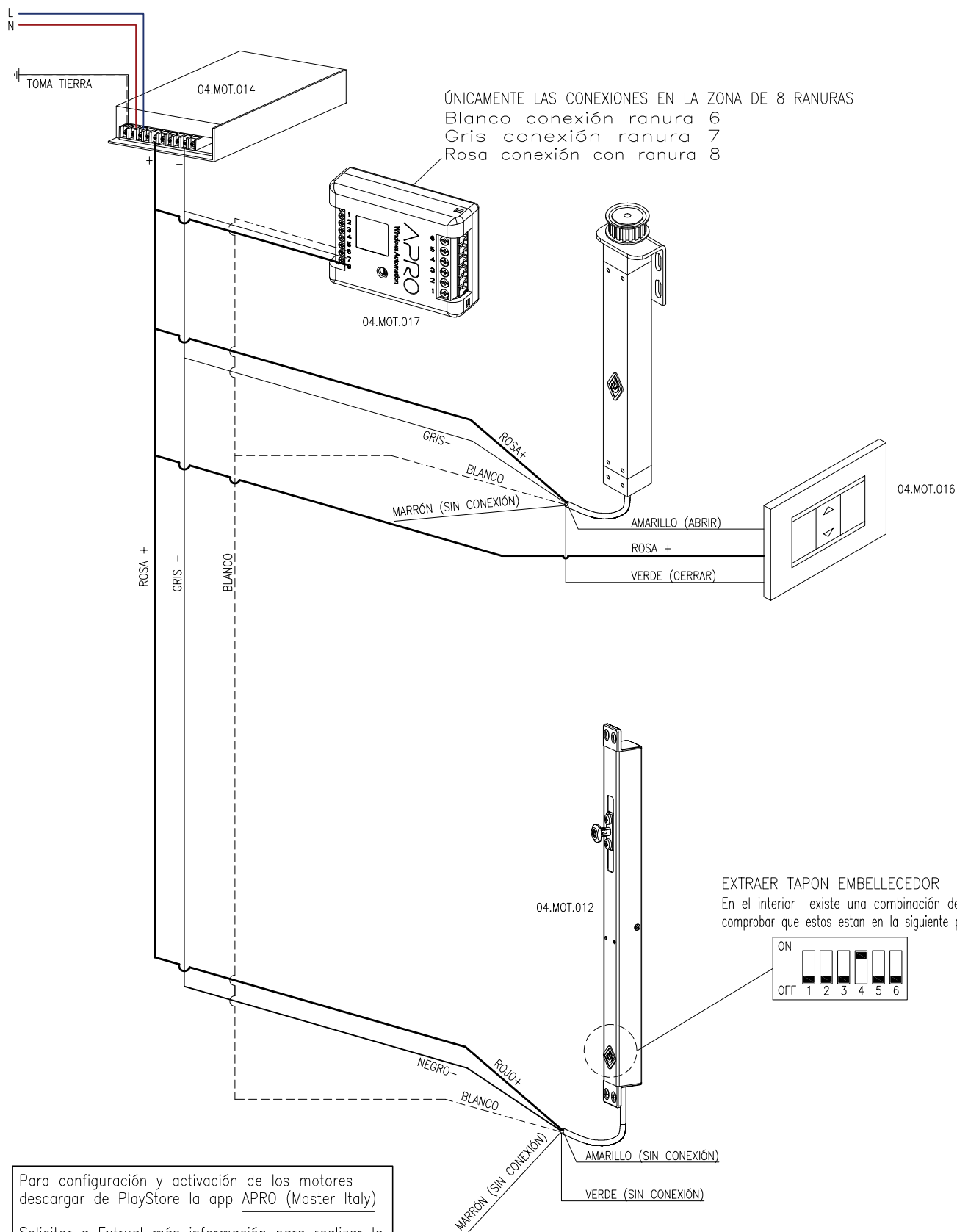

Para configuración y activación de los motores descargar de PlayStore la app APRO (Master Italy)
 Solicitar a Extrual más información para realizar la instalación.

CONEXIÓN ELÉCTRICA DE 2 ó 3 MOTORES SINCRONIZADOS Y ELECTROCERRADURA

RECOMENDACION: Instalar una batería 24V de seguridad para el caso de corte de corriente

ÚNICAMENTE LAS CONEXIONES EN LA ZONA DE 8 RANURAS
 Blanco conexión ranura 6
 Gris conexión ranura 7
 Rosa conexión con ranura 8

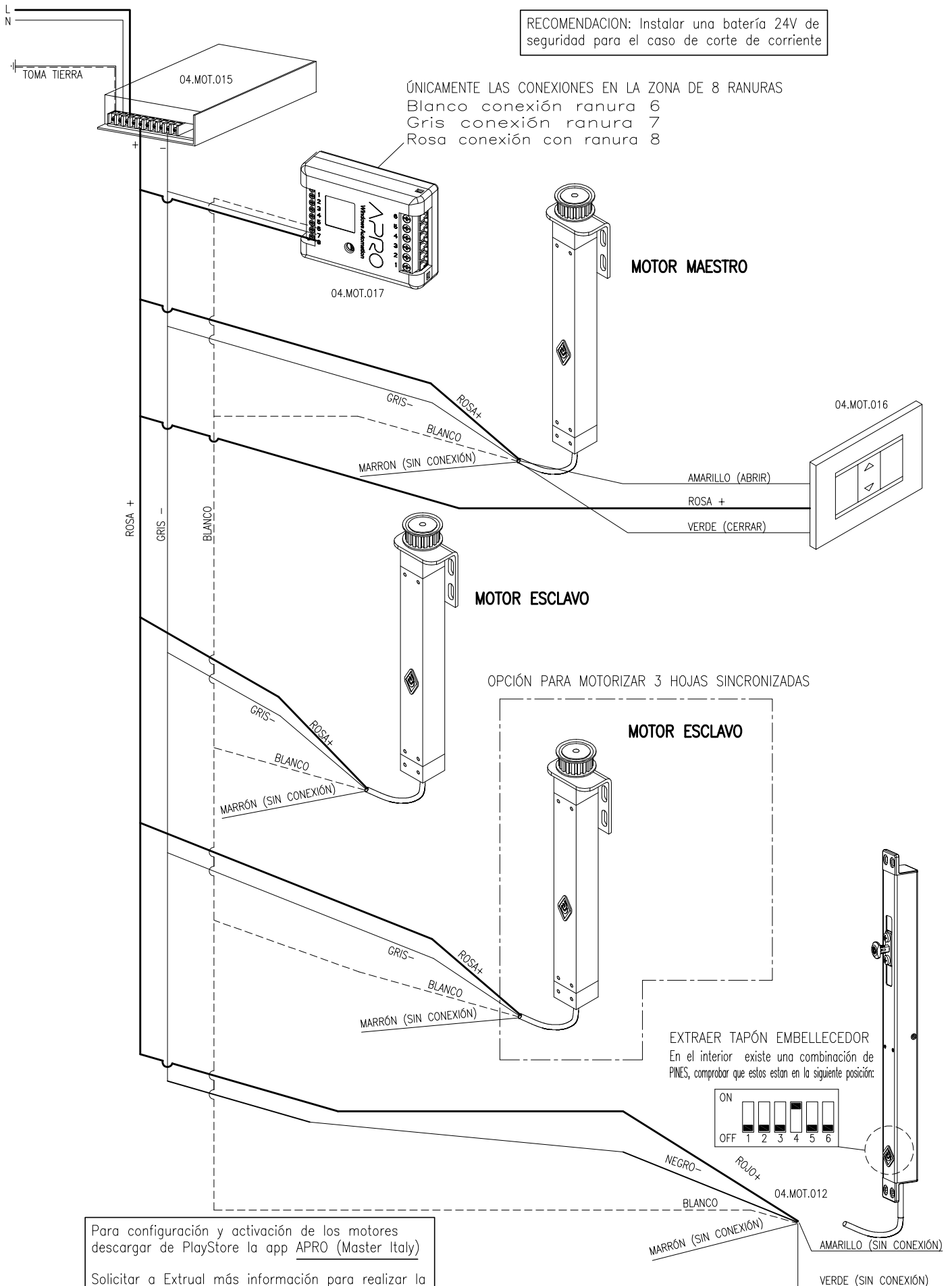

Para configuración y activación de los motores descargar de PlayStore la app APRO (Master Italy)
 Solicitar a Extrual más información para realizar la instalación.

CONEXIÓN ELÉCTRICA DE 2 MOTORES SINCRONIZADAS y CIERRE CON 2 ELECTROCERRADURA DE PISTÓN

RECOMENDACION: Instalar una batería 24V de seguridad para el caso de corte de corriente

ÚNICAMENTE LAS CONEXIONES EN LA ZONA DE 8 RANURAS
 Blanco conexión ranura 6
 Gris conexión ranura 7
 Rosa conexión con ranura 8

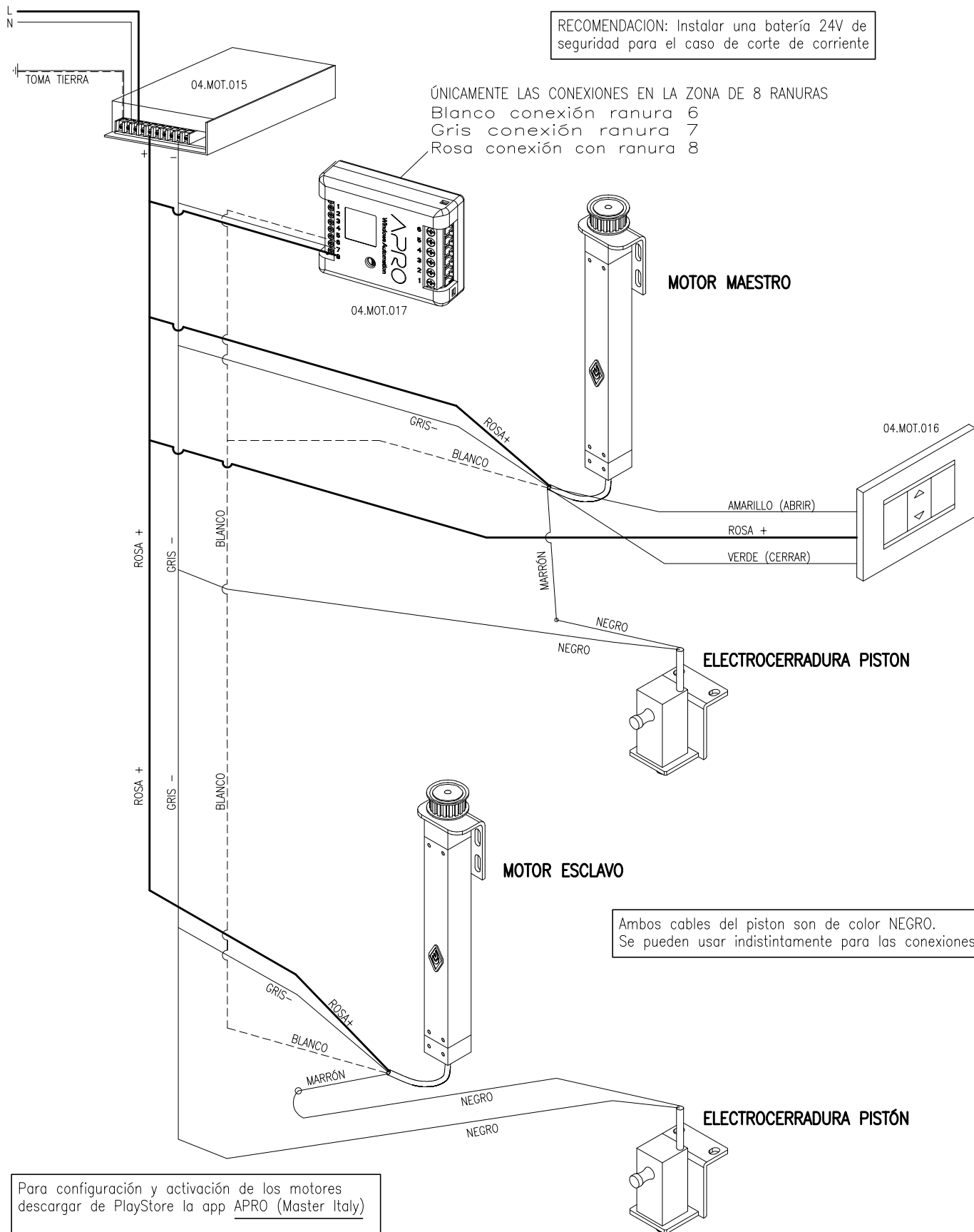

Para configuración y activación de los motores descargar de PlayStore la app APRO (Master Italy)
 Solicitar a Extrual más información para realizar la instalación.

Ambos cables del piston son de color NEGRO.
 Se pueden usar indistintamente para las conexiones.

CONEXIÓN ELÉCTRICA DE 2 MOTORES SINCRONIZADOS y CIERRE CON 1 ELECTROCERRADURA DE PISTÓN

RECOMENDACION: Instalar una batería 24V de seguridad para el caso de corte de corriente

ÚNICAMENTE LAS CONEXIONES EN LA ZONA DE 8 RANURAS
 Blanco conexión ranura 6
 Gris conexión ranura 7
 Rosa conexión con ranura 8

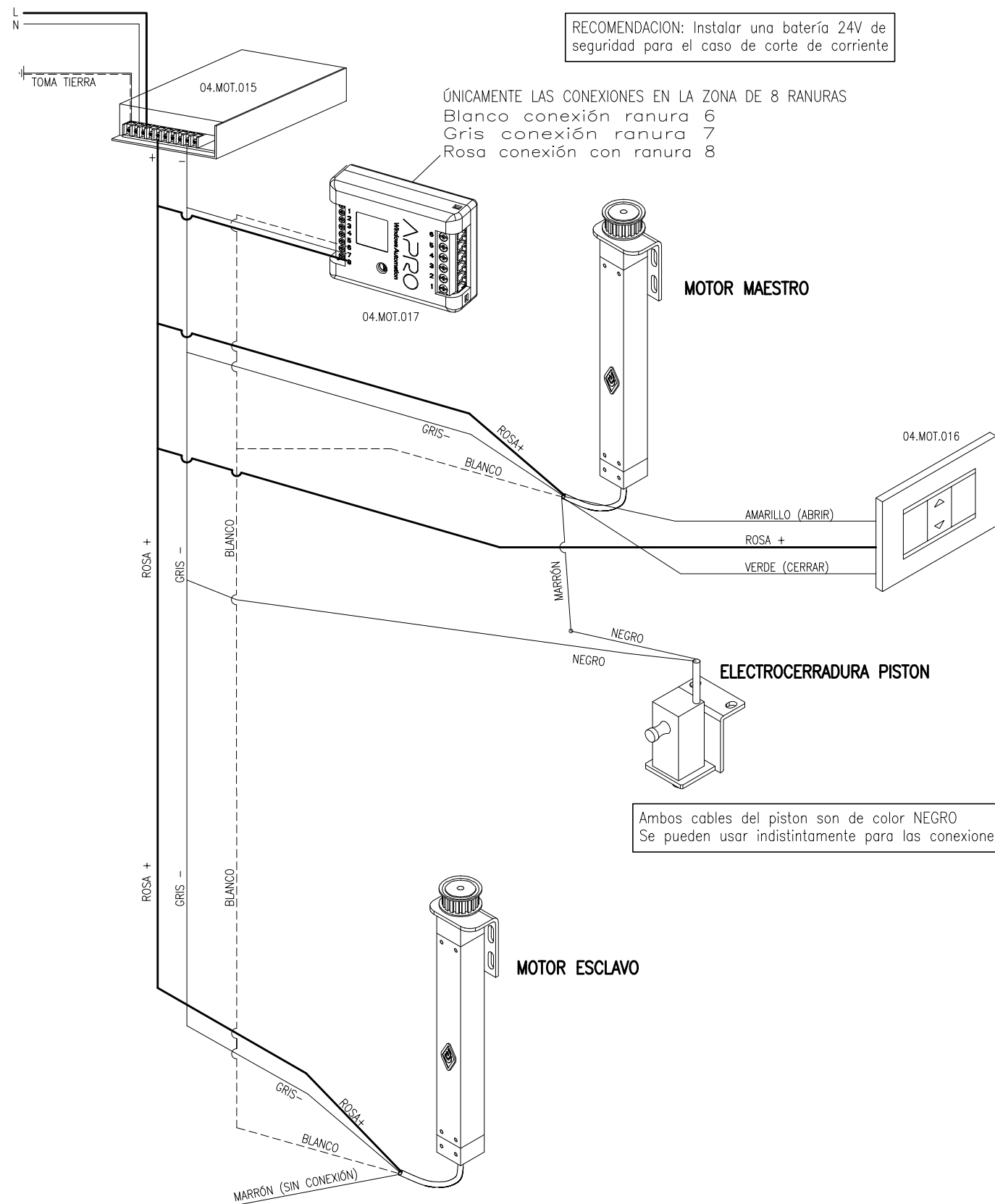

Ambos cables del piston son de color NEGRO
 Se pueden usar indistintamente para las conexiones.

Para configuración y activación de los motores descargar de PlayStore la app APRO (Master Italy)
 Solicitar a Extrual más información para realizar la instalación.

MECANIZADO DE LA TAPA 16.858

El mecanizado se realiza con el Troquel 04.TRO.E150M

MECANIZADO EN TAPAS LATERALES

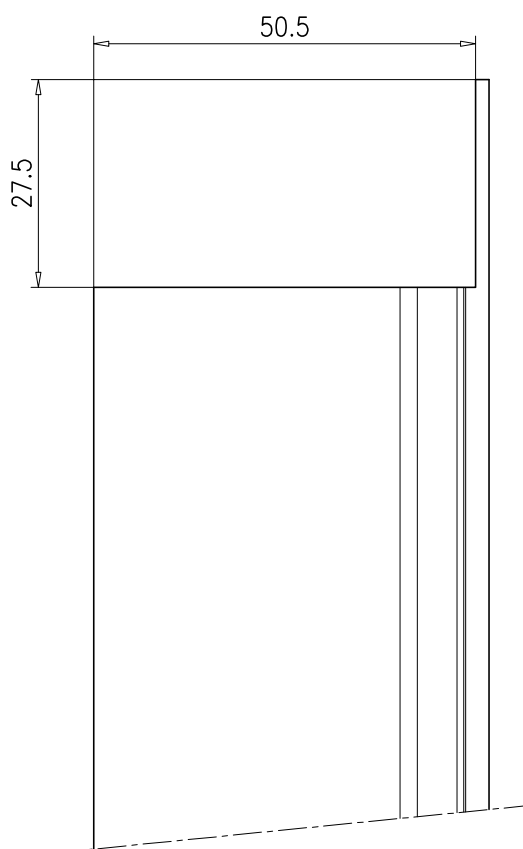
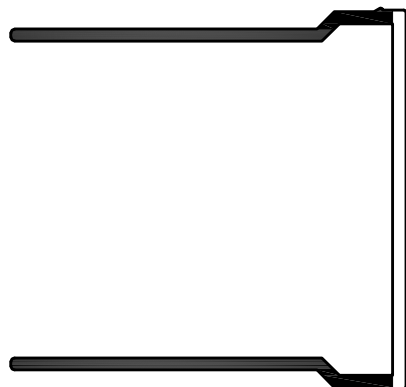

Se realiza en la parte superior e inferior de la tapa para facilitar su colocación en los marcos laterales.

MECANIZADO EN TAPAS SUP/INF PARA HOJAS FIJAS

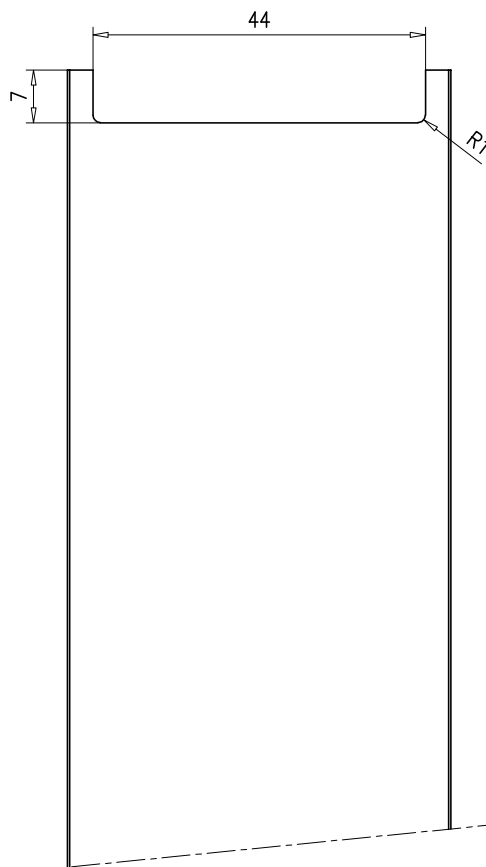
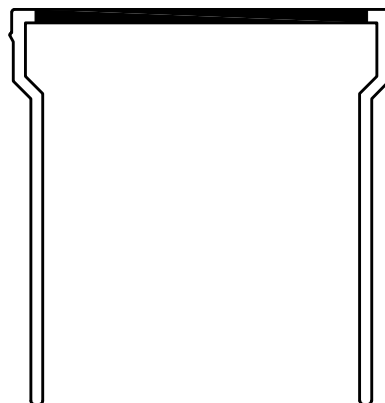

Junto con el anterior se realiza en la parte que ajusta con la hoja fija tanto en la tapa que se coloca en el marco superior como la que se coloca en el inferior.