



serie E150

EXTRUAL

extruidos
del aluminio ■ ■ ■

Sistema de Ventana y Puerta Corredera de grandes dimensiones con Hojas de hasta 500Kgs de peso, con Rotura de Puente Térmico. Muy competitiva y desarrollada para optimizar el montaje reduciendo tiempos y mecanizados.

Estética minimalista de líneas rectas con marcos ocultos en obra y solo 35mm vistos en montante vertical lateral y 25mm en montante central. Marco inferior enrasado para una accesibilidad plena sin barreras. Sistema de drenaje oculto registrable integrado

Marcos de 2 carriles de 128mm, de 3 carriles de 197mm y de 4 carriles de 266mm, que permiten realizar instalaciones de 1 a 8 hojas en combinación con fijos o esquinas interiores y exteriores, así como la posibilidad de esconder las hojas en el muro en su apertura.

Posibilidad de motorizar la apertura de las hojas, ideal para personas con movilidad reducida.

Estanqueidad; Superior e Inferior con Felpudos Tri-Fin que garantizan el deslizamiento de las hojas. Cierres Laterales y Central con Juntas de EPDM que aseguran un comportamiento inmejorable en permeabilidad al aire CLASE 4 y excelente en estanqueidad al agua CLASE 9A.

Acristalamiento de 36mm con silicona estructural DOWSIL 775 InstanFix realizado por el carpintero en sus propias instalaciones, lo que le permite seleccionar al proveedor de vidrio.

Perfilería extruida en aluminio en aleación 6063, tratamiento térmico T5, según normas EN 515, EN 573-3 y EN 755-2, bajo certificación ISO 9001. Las tolerancias dimensionales y de espesor se ajustan a la norma UNE-EN 12020-2

Rotura de puente térmico mediante perfiles de poliamida 6.6 reforzada con un 25% de fibra de vidrio. Unión garantizada entre aluminio y poliamida con una resistencia mínima a la Tracción de 80 N/mm y al Cizallamiento de 30 n/mm.

Protección superficial; Lacado con garantía QUALICOAT-SEASIDE con espesor mínimo de 60 micras, o Anodizado con espesor mínimo 15 micras con garantía QUALANOD (EWAA-EURAS).

Los herrajes han sido diseñados o seleccionados por EXTRUAL, a través de los distintos ensayos realizados aseguran la calidad del producto final.

Resultado de los ensayos realizados en TECNALIA Laboratorio Oficial acreditado por ENAC según Norma UNE-EN 14351-1:2006 en Balconera de 2 Hojas.

Permeabilidad al aire según Norma UNE-EN 1026-2017; CLASE 4
Estanqueidad al agua según Norma UNE-EN 1027-2017; CLASE 9A
Resistencia al viento según Norma UNE-EN 12211-2017; CLASE C5
Coeficiente de Transmisión Térmica según CTE 2015 y UNE-EN 10077-1; U_w = Desde 0,9 W/m K
Aislamiento Acústico según Norma UNE-EN 12354-3 e ISO 717-1; R_w = Hasta 42 dB

Las dimensiones de corte indicadas en este catálogo son teóricas, y pueden verse afectadas mínimamente por las tolerancias de extrusión de los perfiles o por los tratamientos de lacado y anodizado, así mismo deben de adaptarse a la precisión de las máquinas de corte de cada taller, por lo que es aconsejable fabricar una muestra para su control dimensional.

Es fundamental realizar las salidas de evacuación de agua en marcos y sellar correctamente los cortes e ingletes para evitar infiltraciones.

Sólo se garantiza el correcto funcionamiento del sistema si se han utilizado los perfiles y accesorios propios del mismo recogidos en este catálogo o en su caso recomendados por EXTRUAL.

Los momentos de inercia de los perfiles compuestos RPT son teóricos y orientativos y corresponden a los momentos de la sección equivalente de aluminio, están calculados respecto a los ejes X-Y con origen en el centro de gravedad de la sección transversal del perfil.

Las dimensiones máximas de los cerramientos, su fabricación, acristalamiento y puesta en obra de los productos construidos con los Sistemas EXTRUAL deben cumplir la Normativa UNE e instrucciones Técnicas vigentes.

Todos los perfiles y accesorios que aparecen en este catálogo son propios de EXTRUAL, no pudiendo ser copiados o modificados sin autorización.

EXTRUAL se reserva el derecho a modificar, sin previo aviso, cualquiera de los productos que aparecen en este catálogo. Queda prohibida la reproducción total o parcial de este catálogo sin la autorización expresa por parte de EXTRUAL.













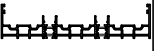























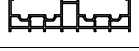
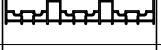

COEFICIENTES DE TRANSMITANCIA TERMICA U_H (W/m²K) Según CTE y UNE-EN 10077-1

$U_{H,v}$	PUERTA 2 HOJAS											
	4,00m ²	5,00m ²	6,00m ²	7,00m ²	8,00m ²	9,00m ²	10,00m ²	11,00m ²	12,00m ²	13,00m ²	14,00m ²	15,00m ²
0,5	1,3	1,2	1,2	1,1	1,1	1,0	1,0	1,0	0,9	0,9	0,9	0,9
0,6	1,4	1,3	1,3	1,2	1,1	1,1	1,1	1,1	1,0	1,0	1,0	1,0
0,7	1,5	1,4	1,3	1,3	1,2	1,2	1,2	1,1	1,1	1,1	1,1	1,1
0,8	1,6	1,5	1,4	1,4	1,3	1,3	1,3	1,2	1,2	1,2	1,2	1,2
0,9	1,6	1,6	1,5	1,5	1,4	1,4	1,4	1,3	1,3	1,3	1,3	1,3
1,0	1,7	1,7	1,6	1,5	1,5	1,5	1,4	1,4	1,4	1,4	1,4	1,4
1,1	1,8	1,8	1,7	1,6	1,6	1,6	1,5	1,5	1,5	1,5	1,5	1,5
1,2	1,9	1,9	1,8	1,7	1,7	1,7	1,6	1,6	1,6	1,6	1,6	1,6
1,3	2,0	1,9	1,9	1,8	1,8	1,7	1,7	1,7	1,7	1,7	1,7	1,6
1,4	2,1	2,0	2,0	1,9	1,9	1,8	1,8	1,8	1,8	1,8	1,7	1,7
1,5	2,2	2,1	2,0	2,0	2,0	1,9	1,9	1,9	1,9	1,9	1,8	1,8
1,6	2,2	2,2	2,1	2,1	2,0	2,0	2,0	2,0	2,0	1,9	1,9	1,9
1,7	2,3	2,3	2,2	2,2	2,1	2,1	2,1	2,1	2,0	2,0	2,0	2,0
1,8	2,4	2,4	2,3	2,3	2,2	2,2	2,2	2,2	2,1	2,1	2,1	2,1
1,9	2,5	2,5	2,4	2,3	2,3	2,3	2,3	2,2	2,2	2,2	2,2	2,2
2,0	2,6	2,5	2,5	2,4	2,4	2,4	2,4	2,3	2,3	2,3	2,3	2,3
2,1	2,7	2,6	2,6	2,5	2,5	2,5	2,4	2,4	2,4	2,4	2,4	2,4
2,2	2,8	2,7	2,7	2,6	2,6	2,6	2,5	2,5	2,5	2,5	2,5	2,5
2,3	2,8	2,8	2,7	2,7	2,7	2,6	2,6	2,6	2,6	2,6	2,6	2,6
2,4	2,9	2,9	2,8	2,8	2,8	2,7	2,7	2,7	2,7	2,7	2,7	2,7
2,5	3,0	3,0	2,9	2,9	2,9	2,8	2,8	2,8	2,8	2,8	2,8	2,8
2,6	3,1	3,1	3,0	3,0	2,9	2,9	2,9	2,9	2,9	2,9	2,9	2,8
2,7	3,2	3,1	3,1	3,1	3,0	3,0	3,0	3,0	3,0	3,0	2,9	2,9
2,8	3,3	3,2	3,2	3,1	3,1	3,1	3,1	3,1	3,1	3,0	3,0	3,0
2,9	3,3	3,3	3,3	3,2	3,2	3,2	3,2	3,2	3,1	3,1	3,1	3,1

U_H Coeficiente de Transmisión Térmica de la puerta completa (W/m²K)

$U_{H,v}$ Coeficiente de Transmisión Térmica del vidrio (W/m²K)

El Coeficiente de Transmisión Térmica es el flujo de calor (W) dividido por la superficie (m²) y por la diferencia de temperatura (K) a cada lado de la puerta.

REFERENCIA	DENOMINACION	DISEÑO	$I_x \text{ cm}^4$	$I_y \text{ cm}^4$	REFERENCIA	DENOMINACION	DISEÑO	$I_x \text{ cm}^4$	$I_y \text{ cm}^4$
R941	Marco		8.83	137.23	16.349	Suplemento Hoja Tapas Aluminio		2.82	5.92
R942	Marco 3 Carriles		10.98	457.59	16.350	Perfil de Cierre Oculta en Muro		4.33	23.80
R943	Hoja Lateral		11.37	6.54	16.351	Canaleta de Drenaje		71.57	96.43
R944	Hoja Lateral Cerradura		13.41	12.73	16.358	Cierre Esquina			
R945	Hoja Superior/Inferior		0.72	5.42	16.608	Tapa Triple Marco Inf. Oculto			
R946	Cierre 4 Hojas		3.29	0.85	16.651	Suplemento Hoja Piso Corrido		13.65	5.84
R947	Esquina		13.59	12.03	16.652	Tapa Central Piso Corrido			
R948	Solera		44.16	168.85	16.653	Tapa Lateral Piso Corrido			
R949	Solera 3 Carriles		69.25	562.07	16.654	Tapa Multiple Piso Corrido			
R952	Marco 4 Carriles		13.01	1085.16	16.657	Cruce Entremuros			
R953	Solera 4 Carriles		94.43	1343.76	16.658	Tapa Lateral Hoja Entremuros			
7.438	Tapeta para 13.248				16.659	Suplemento Tapa Lateral Entremuros			
10.466	Tapa Refuerzo Tirador				16.738	Hoja de Cierre Invertida		14.69	1.28
13.248	Cierre Entremuros				17.002	Tapa Lat. Parquet M. Inf. Oculto			
15.686	Tapa Canaleta de Drenaje				17.335	Remate Pladur			
16.341	Cierre Lateral		0.46	4.27	17.417	Marco "Fria"		12.73	136.78
16.342	Tapa Canal				17.418	Marco 3 Carriles "Fria"		19.32	454.76
16.343	Tapa Marco				17.419	Hoja Lateral "Fria"		9.71	5.91
16.344	Tapa Central Marco Inf. Oculto				17.420	Hoja Superior/Inferior "Fria"		0.55	4.67
16.345	Tapa Lateral Marco Inf. Oculto				17.421	Reductor vidrio "Fria"		0.26	2.11
16.346	Tapa Doble Marco Inf. Oculto								
16.347	Hoja de Cierre		14.69	1.28					
16.348	Refuerzo Tirador		26.58	4.69					

CÁLCULO DE LAS DIMENSIONES DE HOJA MÁXIMA REALIZABLES SEGUN MONTANTE UTILIZADO

Momentos de Inercia obtenidos según la formulación marcada por la Norma UNE-EN 12210:1990. Según los siguientes criterios:
 Se consideran para el cálculo los perfiles intermedios, ya que los laterales, es decir el marco, se suponen unidos rígidamente a obra.
 Se consideran cerramientos sin cajón de persiana.
 Para la aplicación de la fórmula se consideran los extremos apoyados.
 Flecha Máxima Cruce de Hojas: $H/150$

Actuación de la carga de viento sobre la superficie de la ventana.

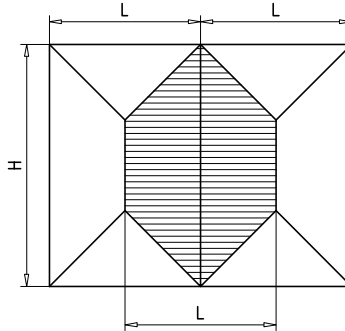

Los cuadros de la siguiente página determinan las dimensiones máximas de hoja realizables (considerando hojas iguales para cada tipo de cerramiento) para las distintas opciones de montantes A, B, C, D, E, F, G, H, I, J

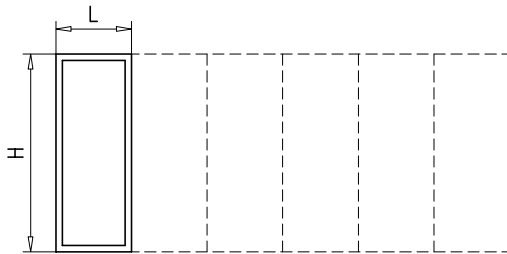

Dimensiones recomendables $H/L = 2.5$
 Peso Máximo por Hoja = 500Kg

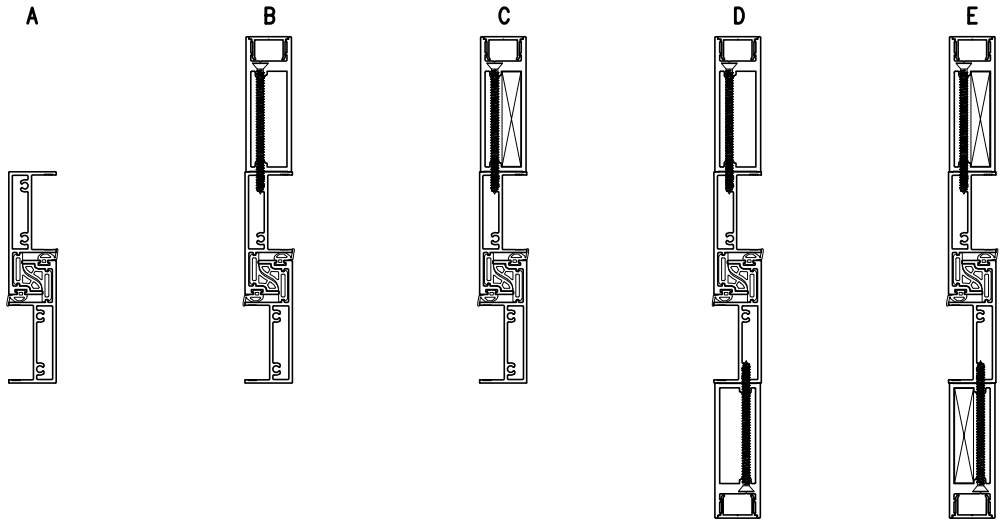
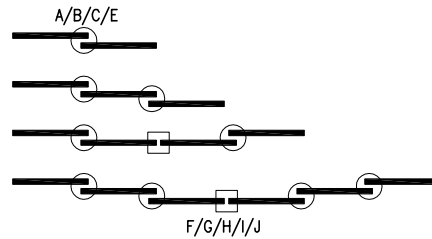

lx: 28.38cm⁴ lx:148.63cm⁴ lx:179.14cm⁴ lx:267.88cm⁴ lx:329.90cm⁴

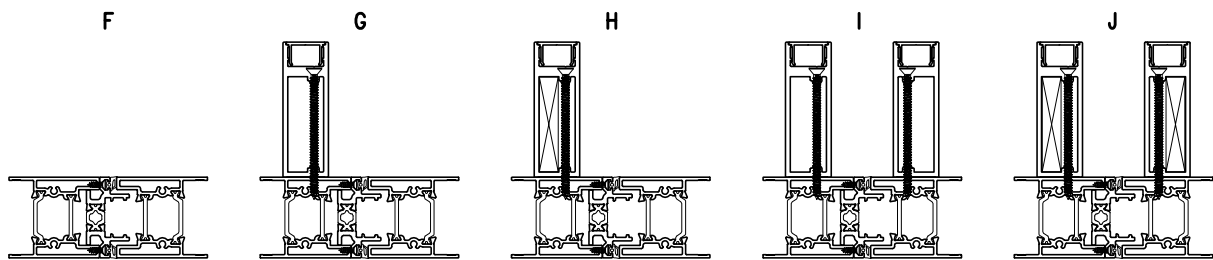

lx: 26.04cm⁴ lx:157.23cm⁴ lx:187.74cm⁴ lx:268.03cm⁴ lx:352.74cm⁴

El refuerzo en G, E, H y J se realiza con pletina de Acero Inox. 50x10

CUADROS DE DIMENSIONES MÁXIMAS POR HOJA SEGUN EL TIPO DE MONTANTE UTILIZADO PARA LAS PRESIONES INDICADAS CON UNA FLACHA MÁXIMA DE H/150

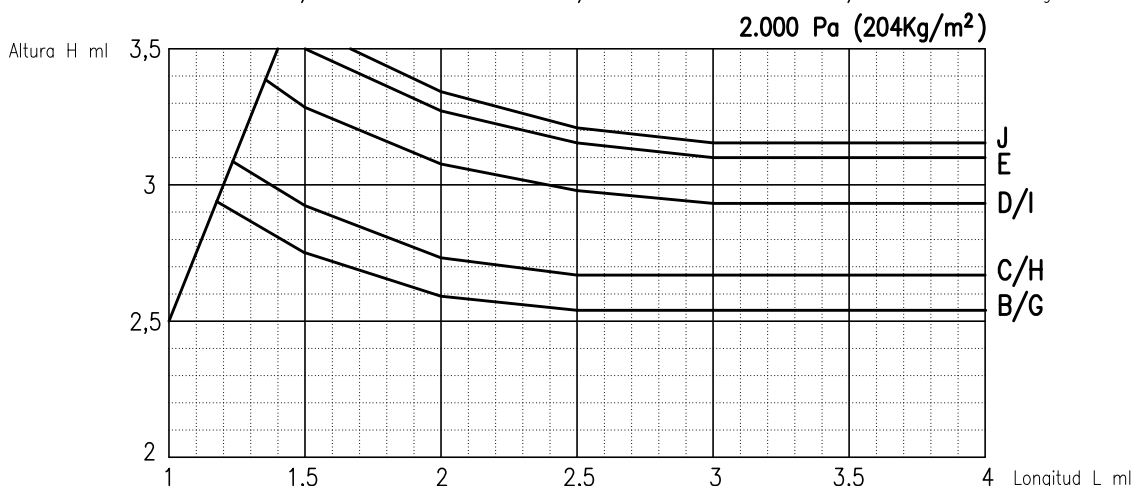
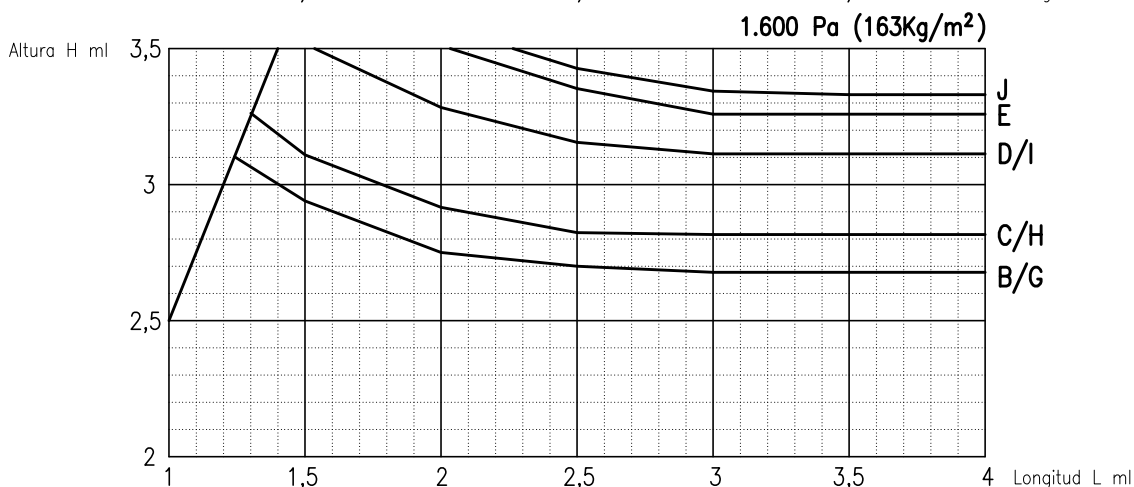
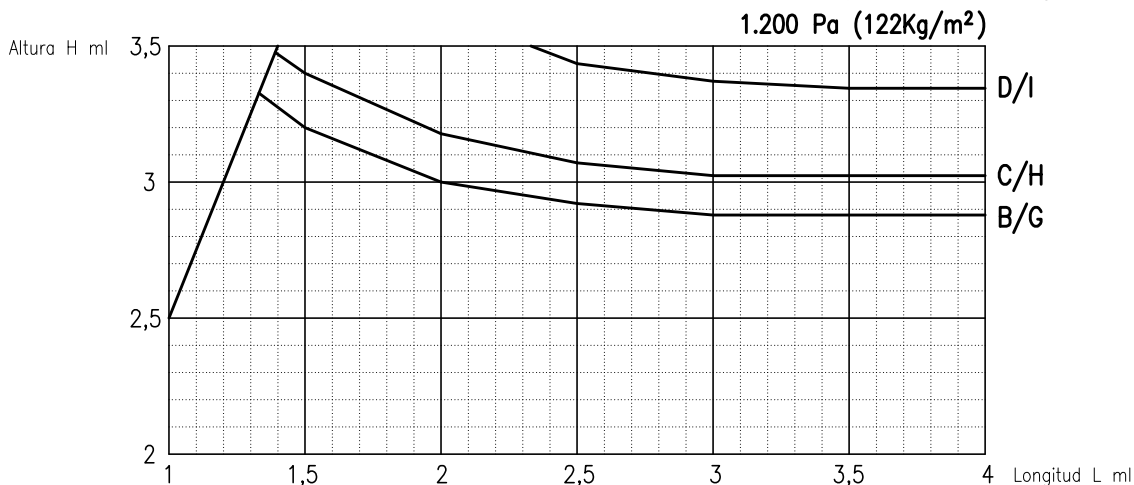
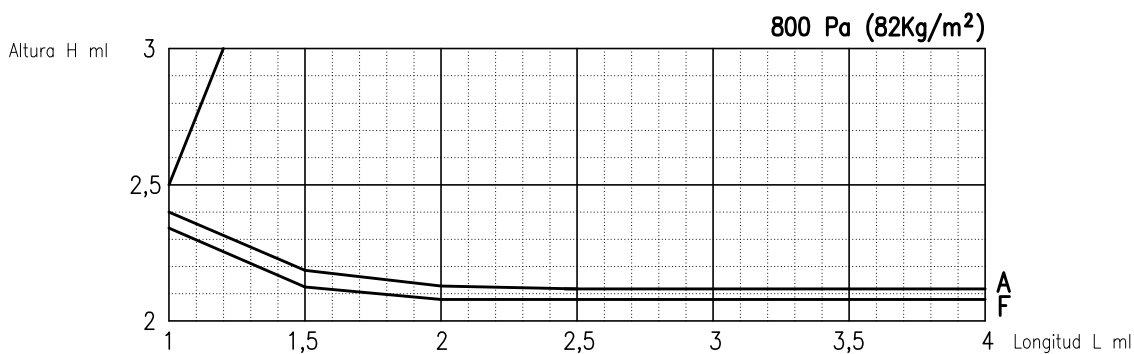

ESTOS CUADROS SON ORIENTATIVOS, SOLO UN CALCULO ESTATICO QUE ATIENDA A LAS PARTICULARIDADES DE CADA OBRA JUSTIFICARA LA UTILIZACION DE UNA U OTRA OPCION, ES NECESARIO COMPROBAR QUE LA FLECHA DEL PERFIL ES COMPATIBLE CON EL VIDRIO UTILIZADO

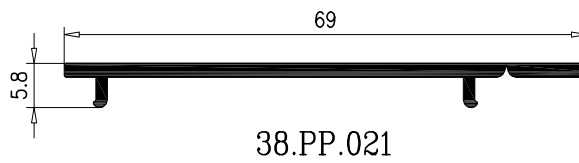
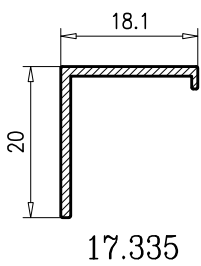
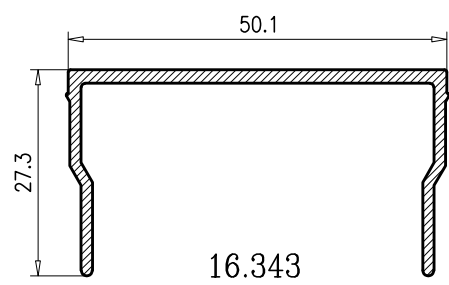
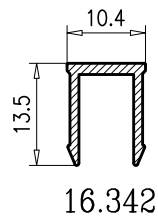
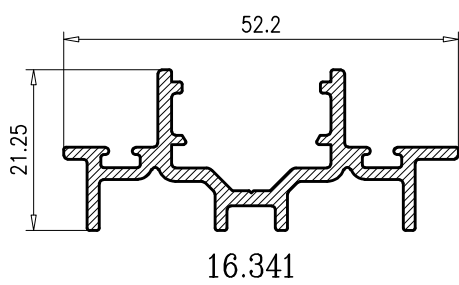
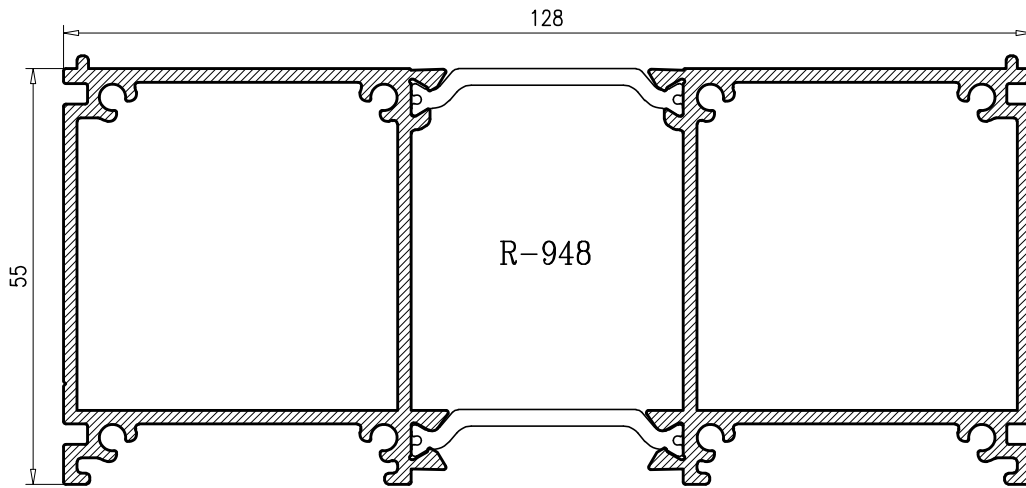
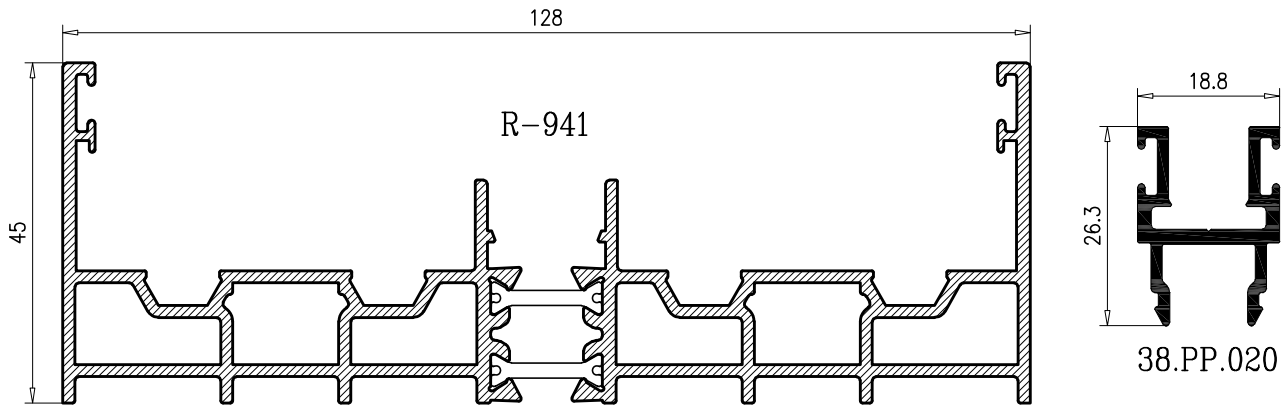

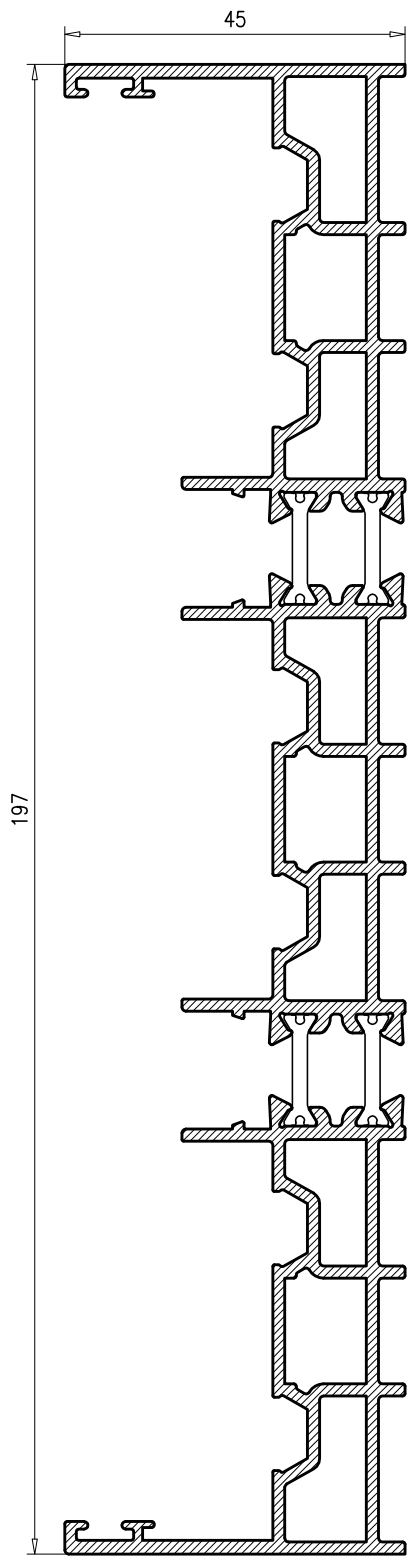

R-942

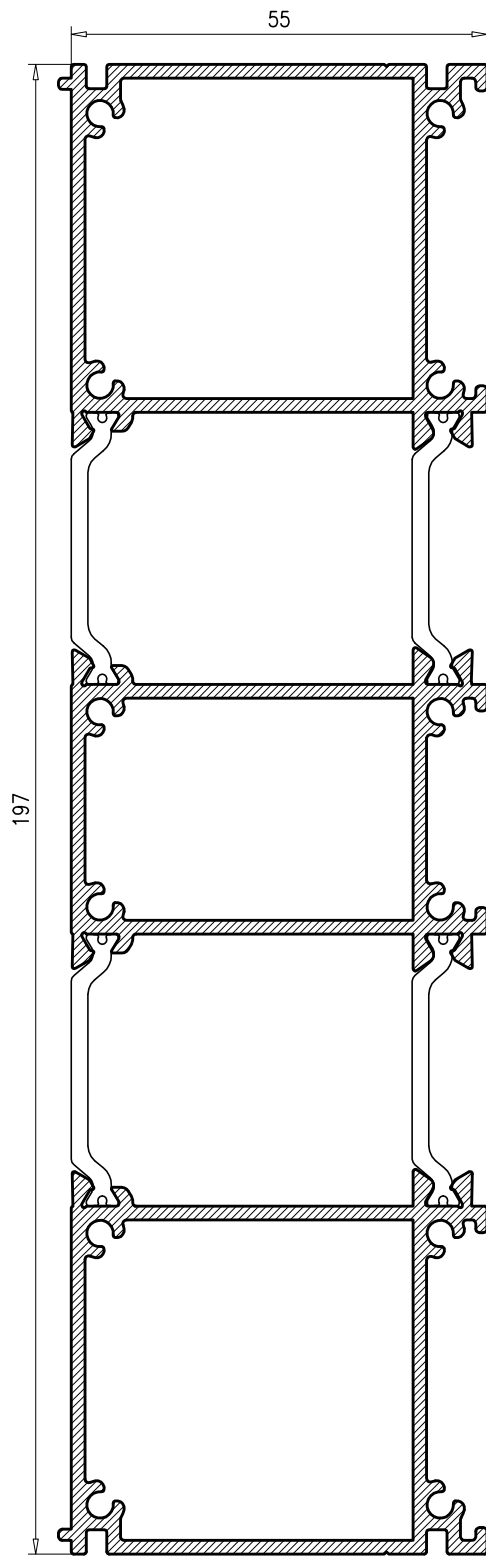

R-949

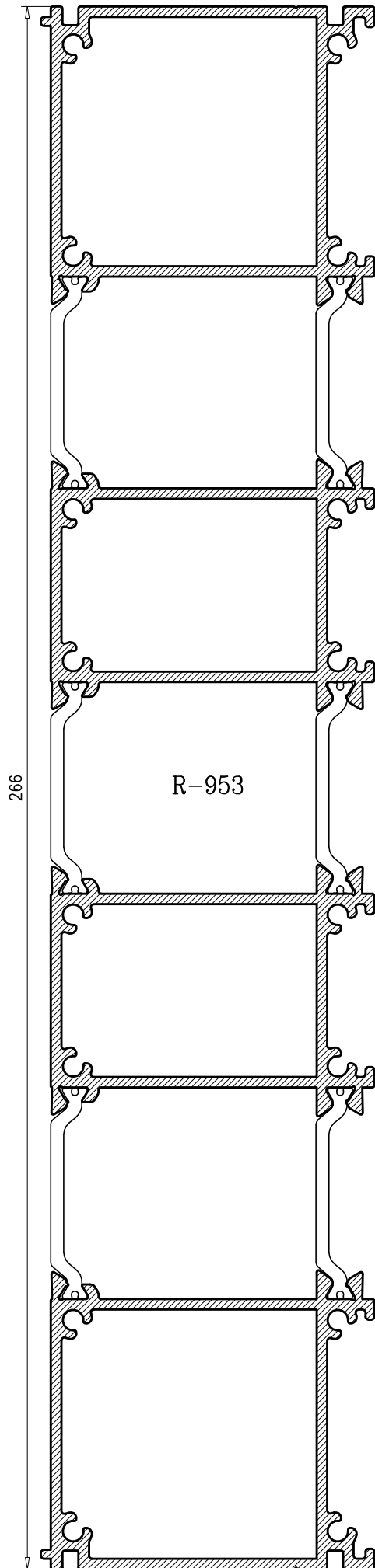
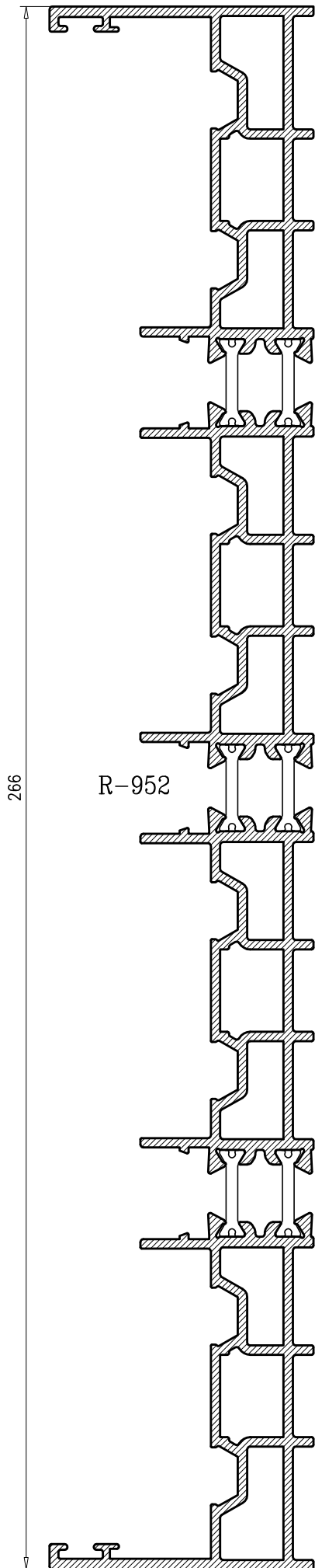

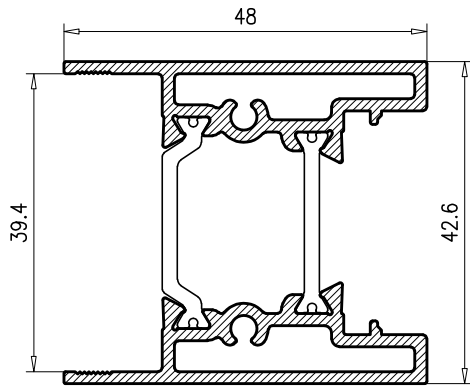

R-943

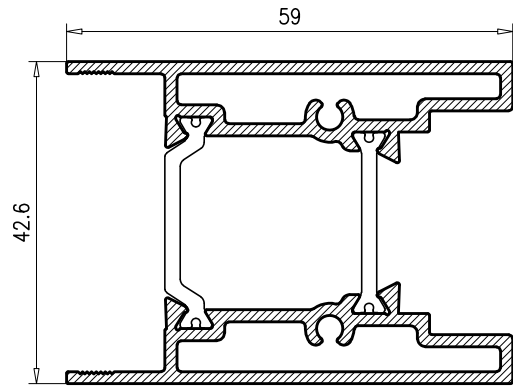

R-944

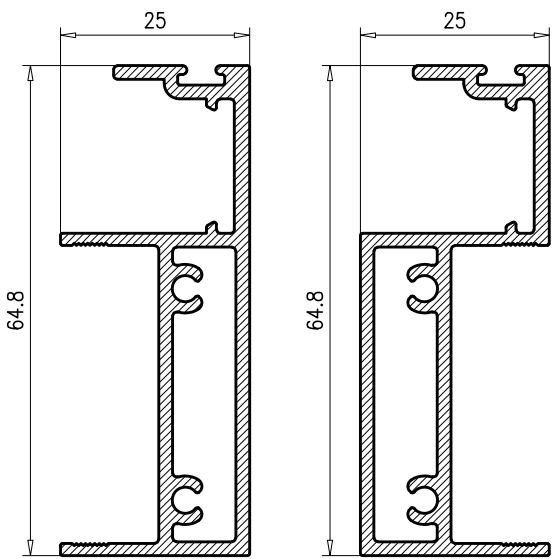

16.347

16.738

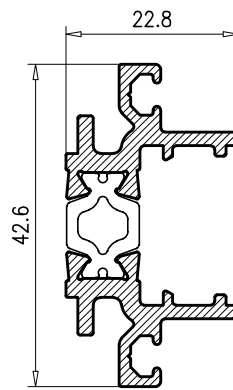

R-946

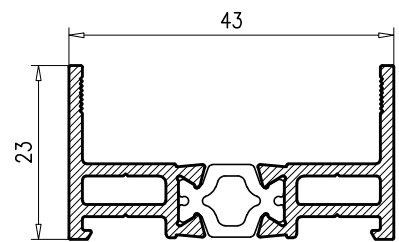

R-945

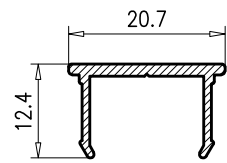

10.466

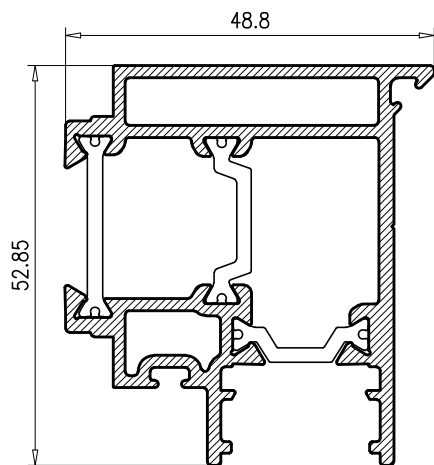

R-947

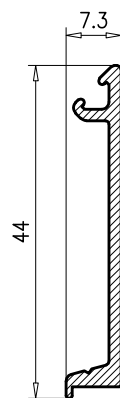

16.358

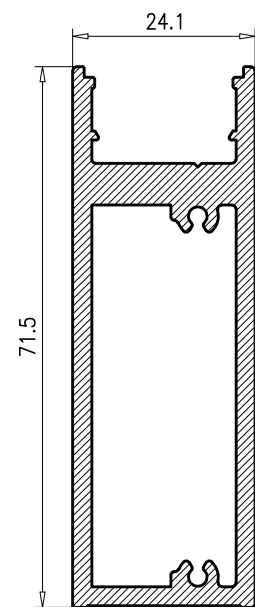

16.348-M970P

LOS SUPLEMENTOS DE HOJA Y LAS TAPAS SIEMPRE VAN ANODIZADOS

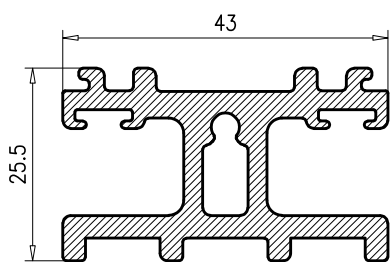

16.349

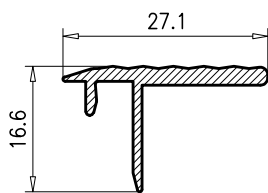

16.345

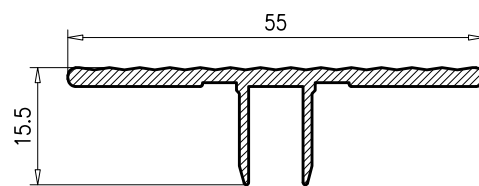

16.344

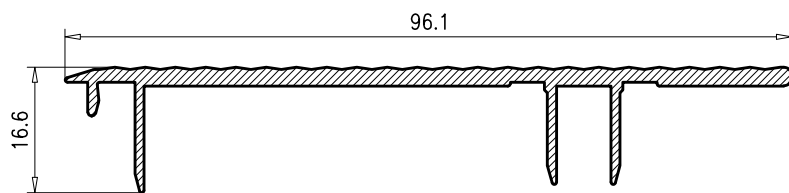

16.346

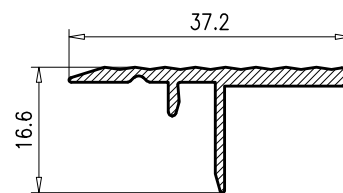

17.002

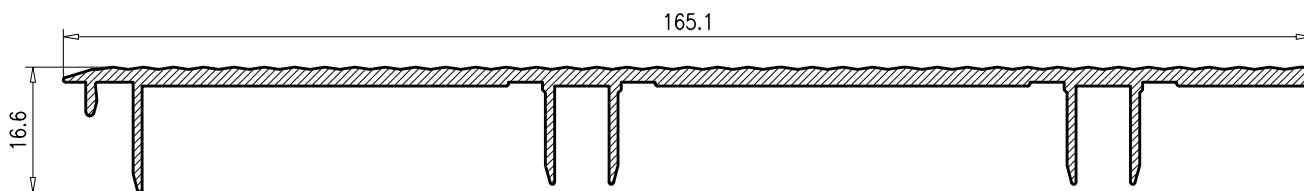

16.608

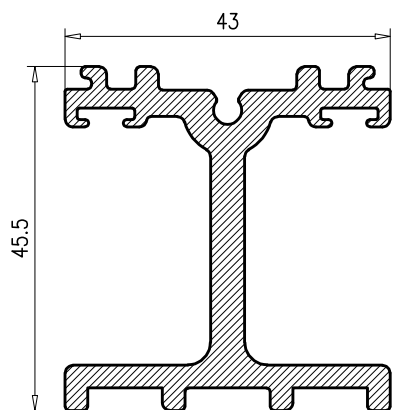

16.651

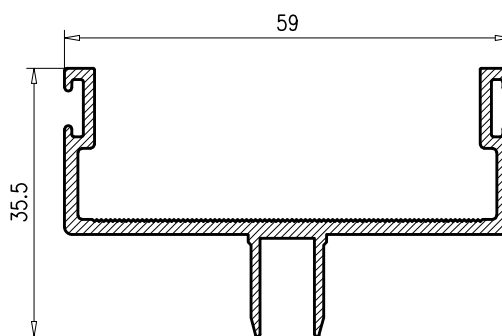

16.652

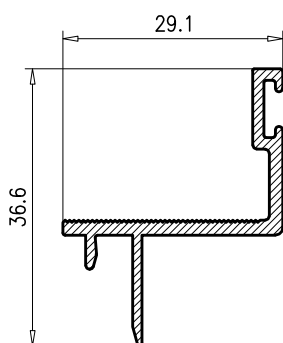

16.653

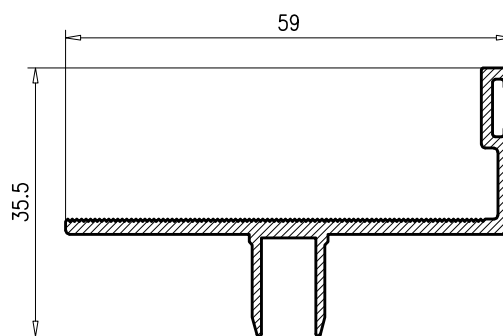

16.654

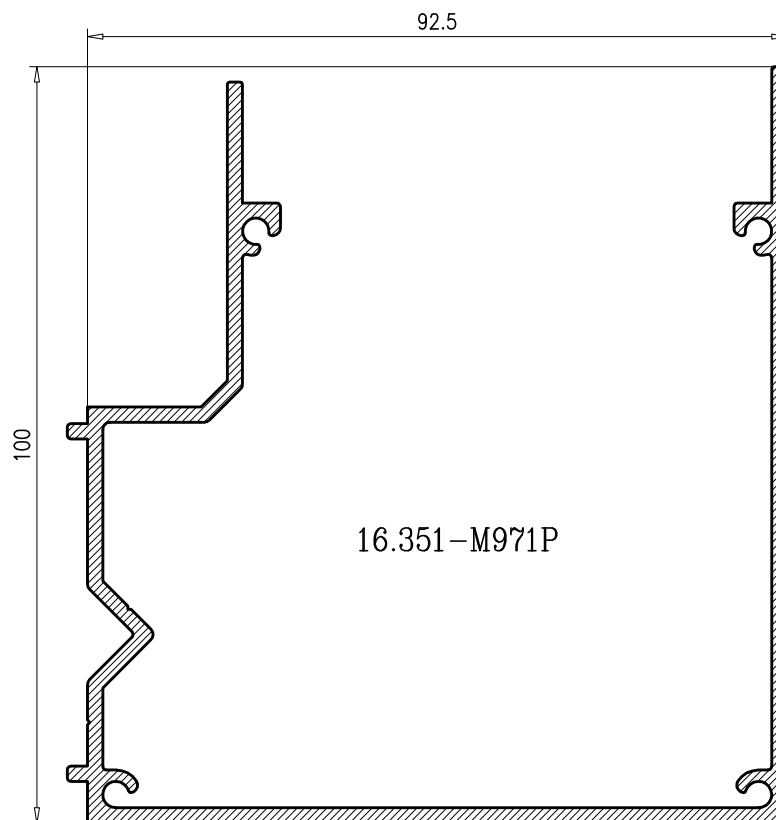
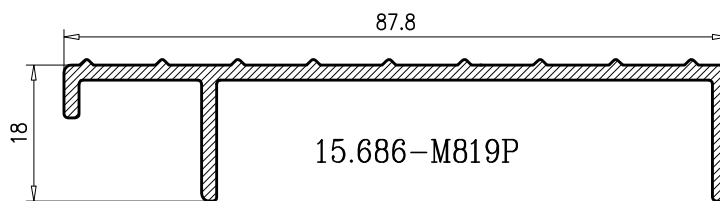
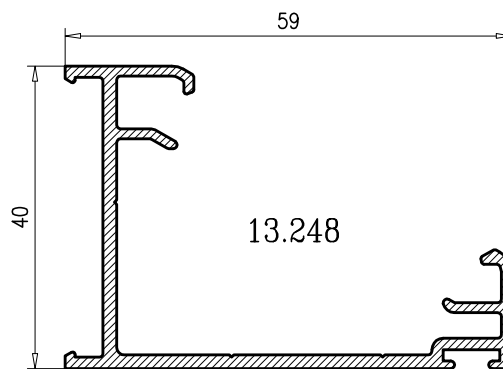
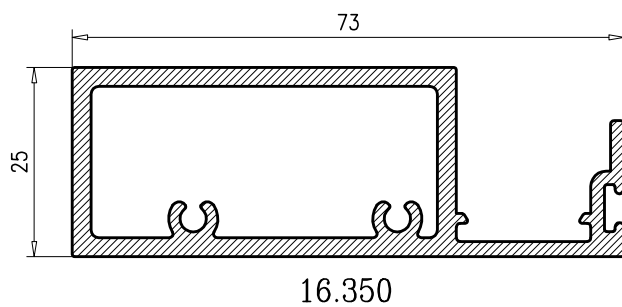
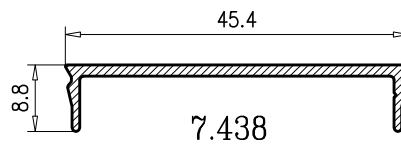
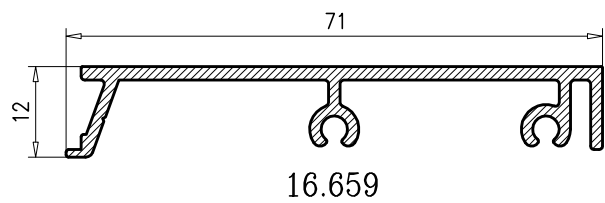
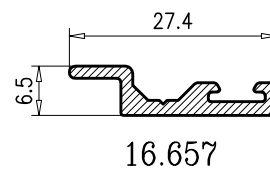
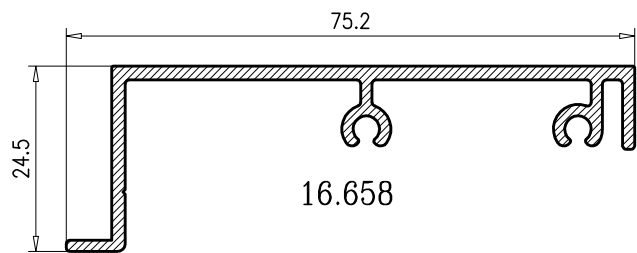

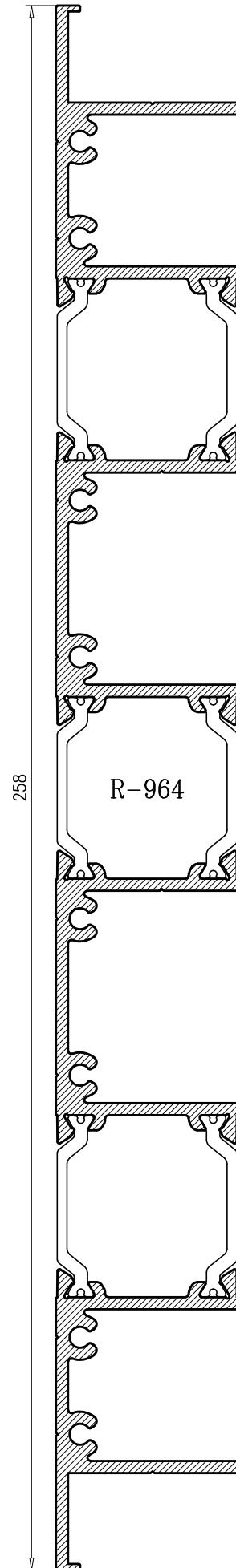
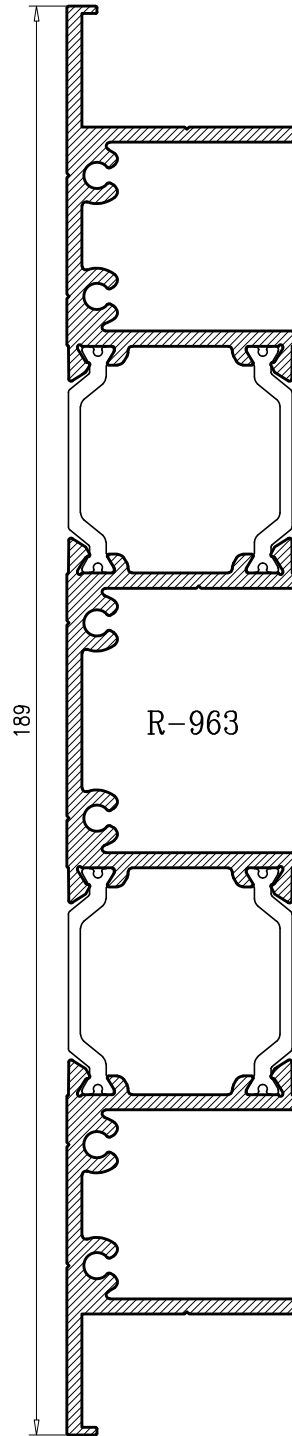
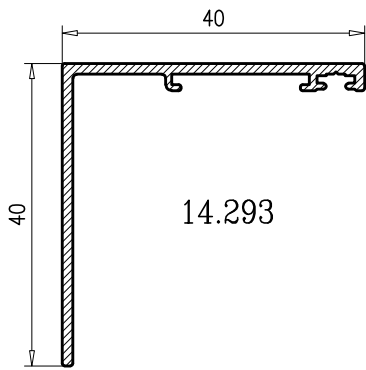
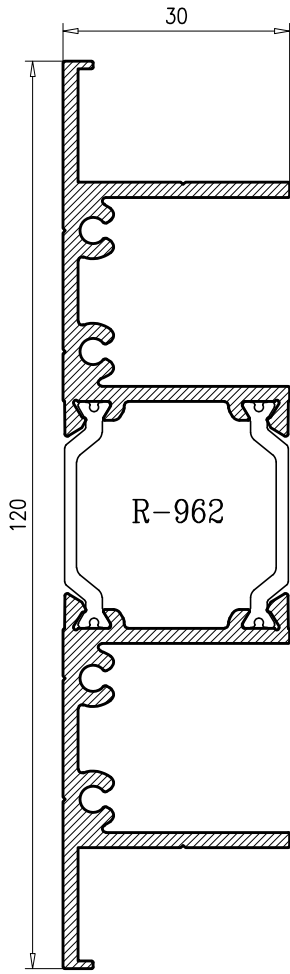

Escuadra Alineamiento Solapes 18x1.5		Junta solape	
	04.EA.004		04.JU.026

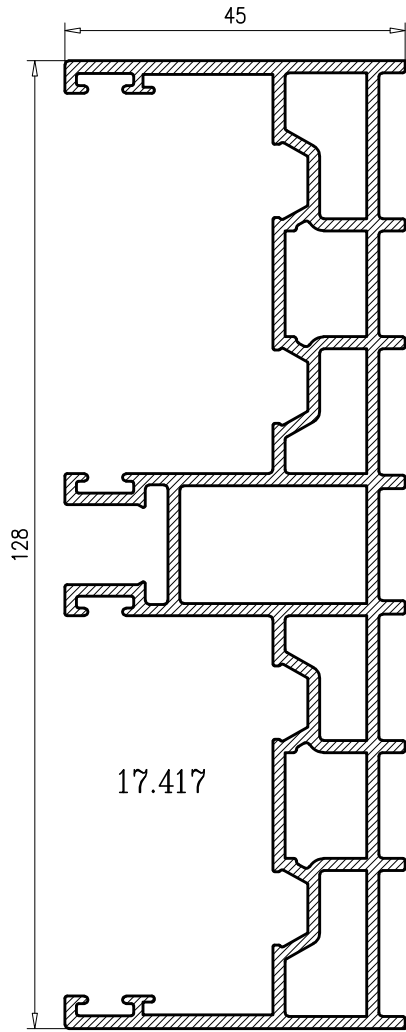

17.417

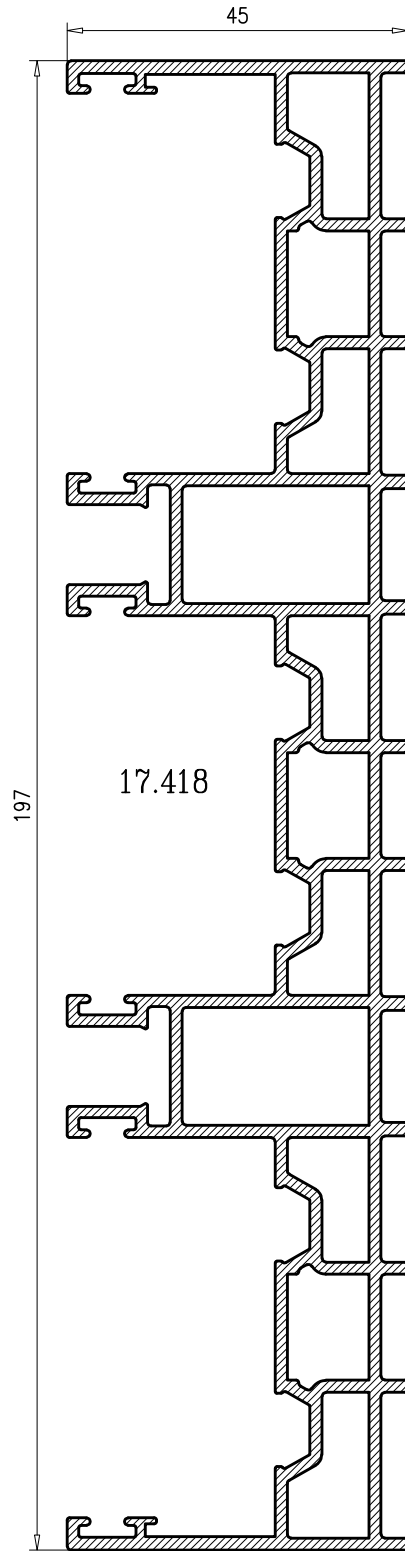

17.418

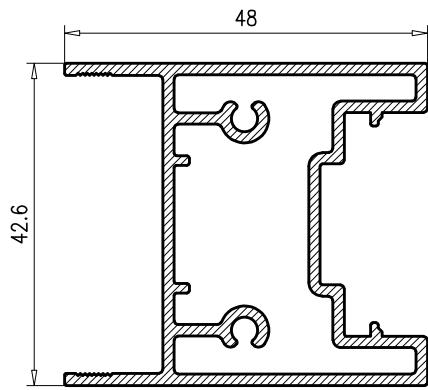

17.419

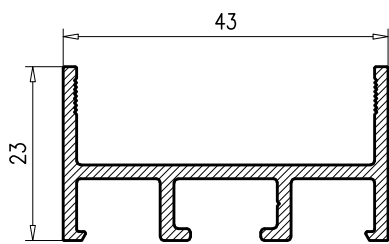

17.420

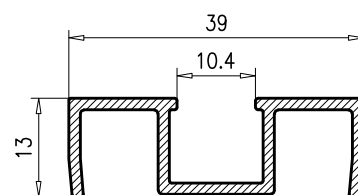

17.421

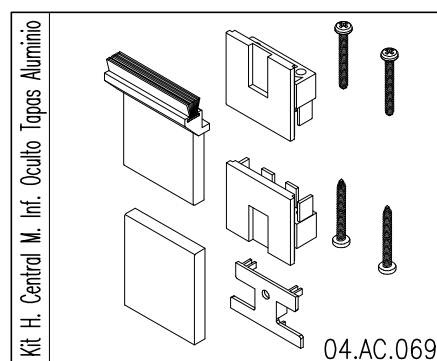
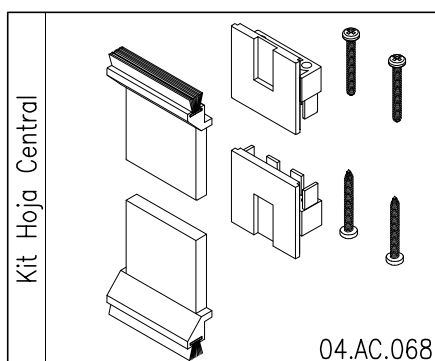
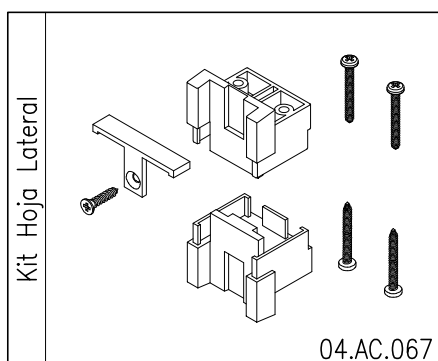
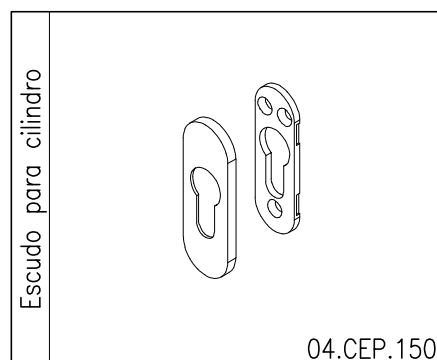
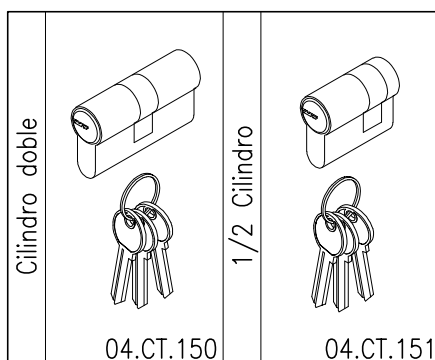
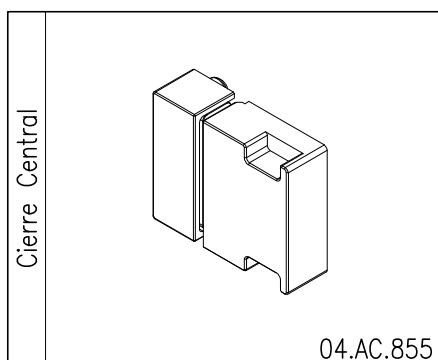
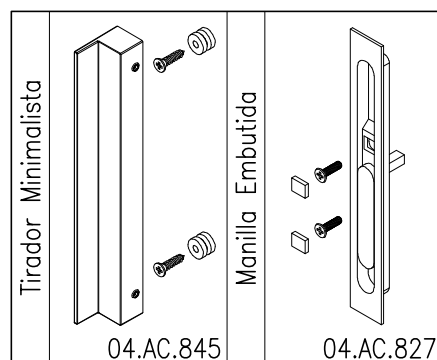
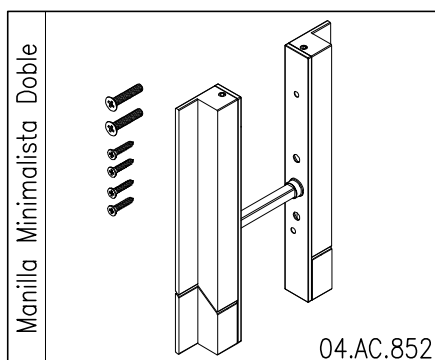
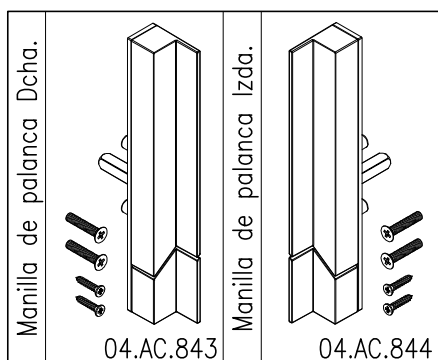
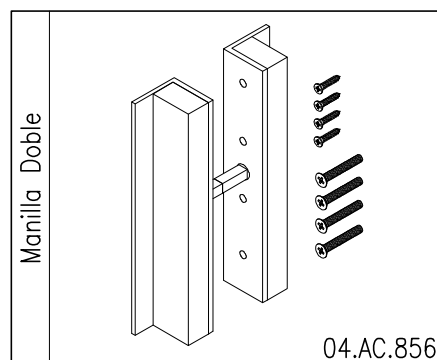
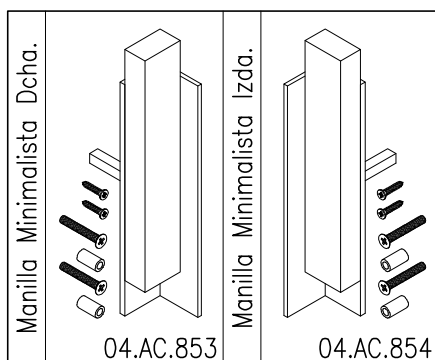
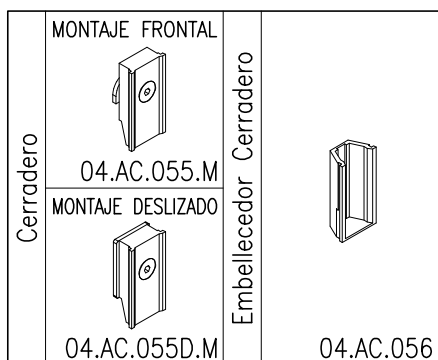
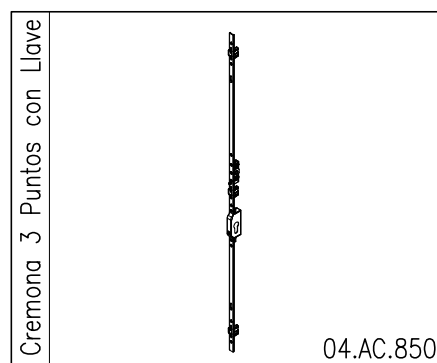
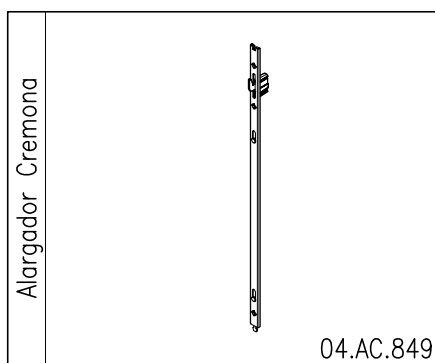
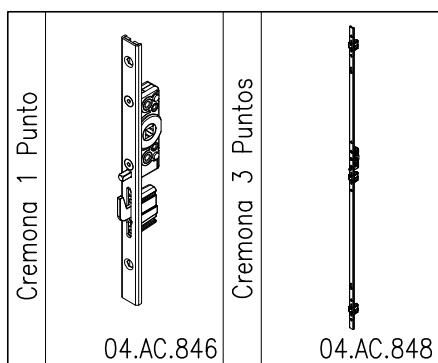

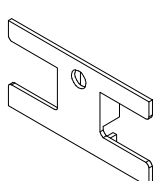
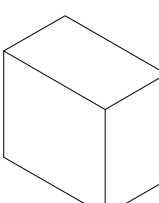
Tapo H. Lateral M. Inf. Oculto Tapas Aluminio		04.AC.070
Taco estanc. M. Inf. Oculto Tapas Aluminio		04.AC.075

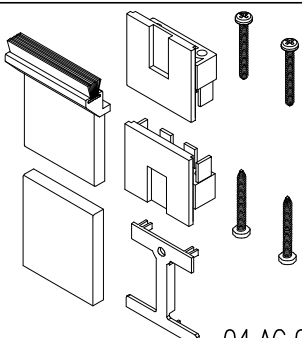
Kit H. Central M. Inf. Oculto Piso Corrido		04.AC.078
--	---	-----------

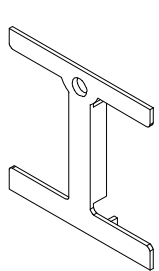
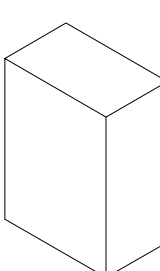

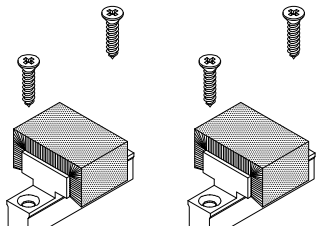
Tapo H. Lateral M. Inf. Oculto Piso Corrido		04.AC.079
Taco estanc. M. Inf. Oculto Piso Corrido		04.AC.081

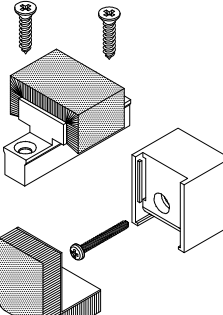

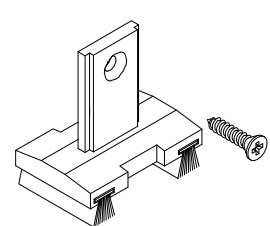
Kit Cortavientos		04.AC.071
------------------	---	-----------

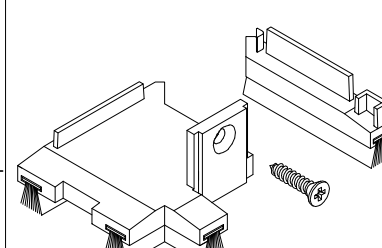

kit Cortavientos Marco Inf. Oculto		04.AC.080
------------------------------------	---	-----------

Tope Inf. 4 Hojas Marco Inf. Oculto		04.AC.076
-------------------------------------	---	-----------



Kit Tope Inf. Esquina M. Inf. Oculto		04.AC.077
--------------------------------------	--	-----------

Junta Cierre Lateral		04.JU.004.D
Junta Cierre 4 Hojas Y Esquina		04.JU.004.E

Felpudo Marco 7x8		04.AC.F10
Felpudo Cruce Central 6x7.5		04.AC.F13



Junta Cruce Central		04.JU.062
Junta Cruce Central		04.JU.067

Junta Tapacanal Marco		04.JU.068
Junta Tapacanal 16.341		04.JU.063

Felpudo Suplementos Hoja 16.349 y 16.651 7x9		04.AC.F09
Felpudo 7x12 Entremuros 7x12		04.AC.F11

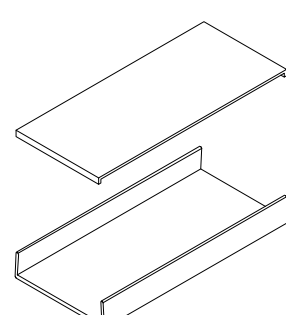
Junta Hoja Fija		04.JA.004
-----------------	---	-----------

Calzo Vidrio		04.AC.073
--------------	---	-----------

Junta Apoyo Carril EPDM		04.JU.069
Junta Apoyo Carril POLIAMIDA		38.PP.023
Barra de 6.5mts		

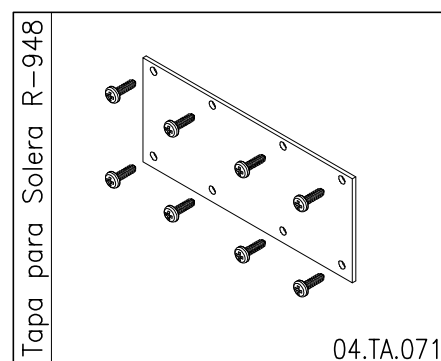
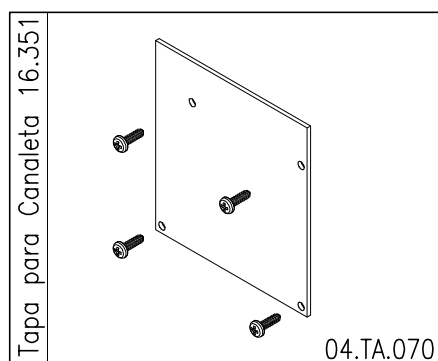
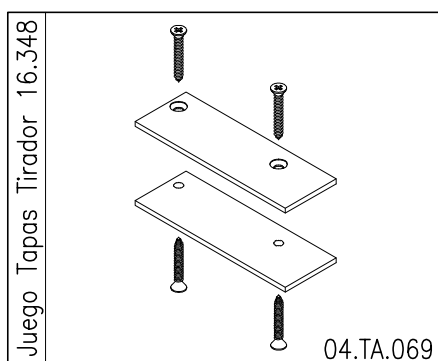
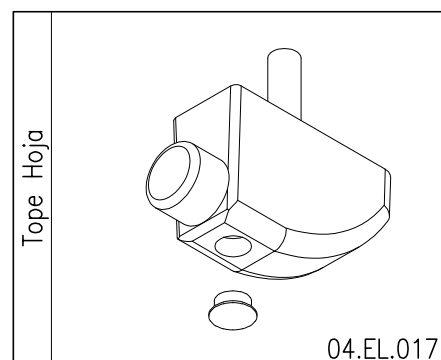
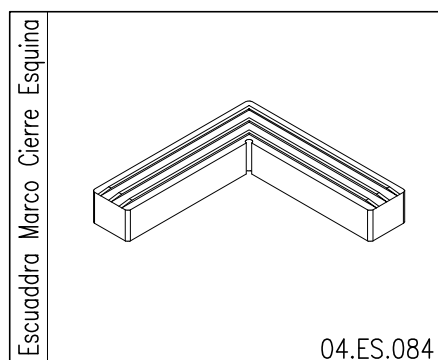
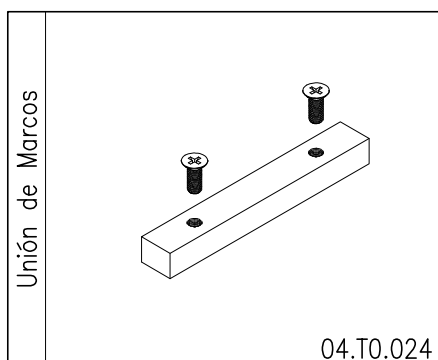
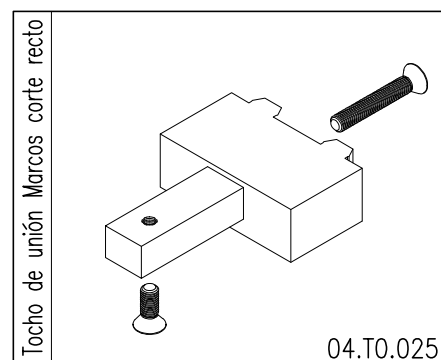
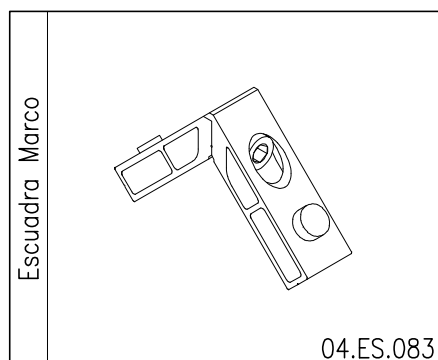
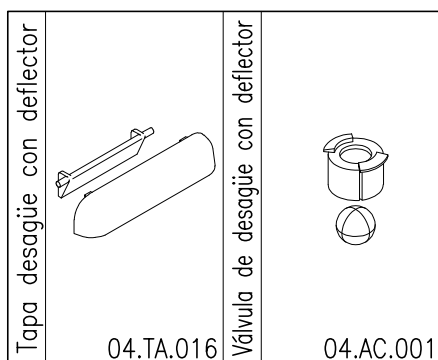
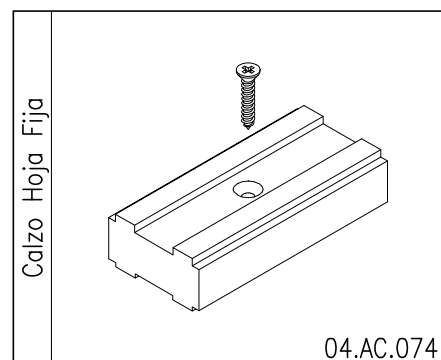
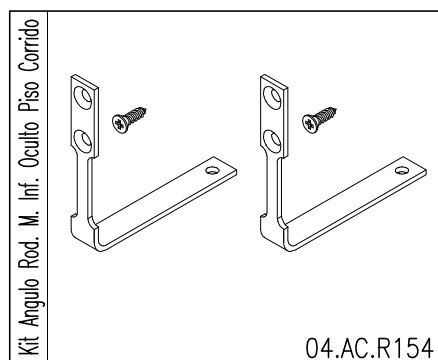
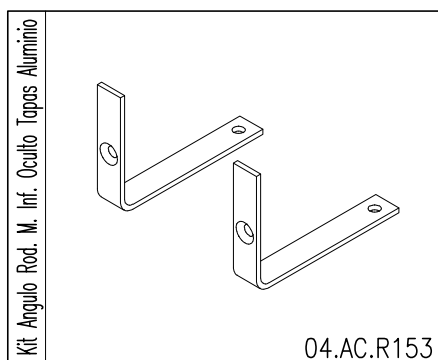
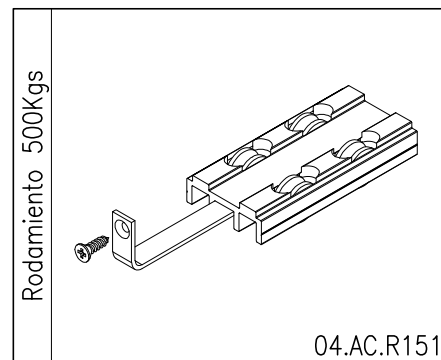
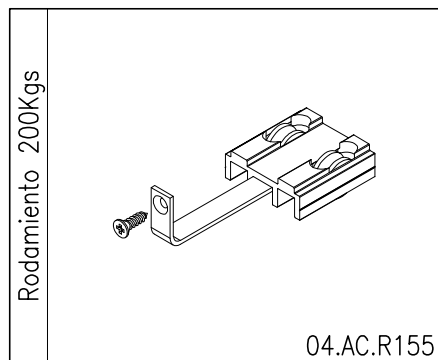
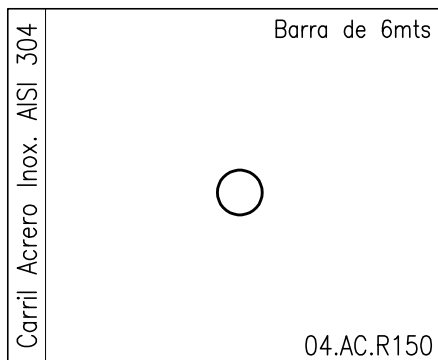

Tapa para Solera R-949

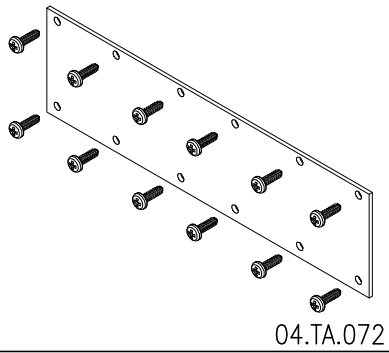

04.TA.072

Tapa para Solera R-953

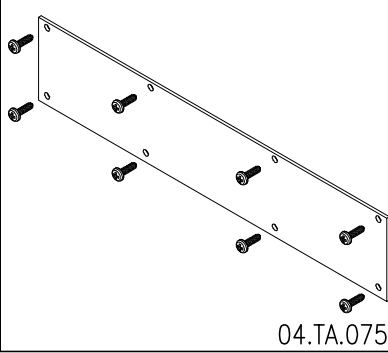

04.TA.075

Troquel

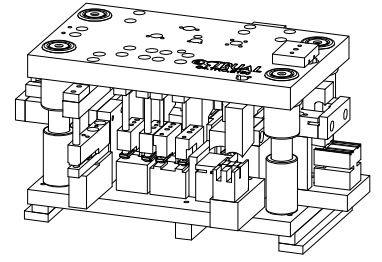

04.TRO.E150

Juego de Fress perfil 16.350

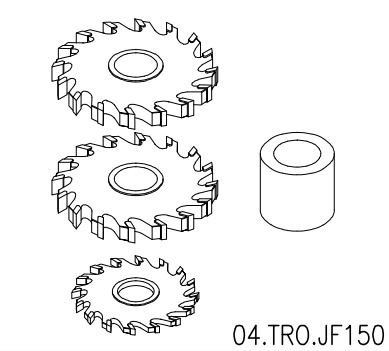

04.TRO.JF150

SECCION VERTICAL SOLERA Y CANAL DE DESAGUE

ES FUNDAMENTAL LA CORRECTA COLOCACION Y NIVELACION DE LA SOLERA R-948 Ó R-949 PARA EL BUEN FUNCIONAMIENTO DEL SISTEMA
Tanto el perfil canaleta 16.351 como la tapa de registro 15.686 se suministran mecanizados

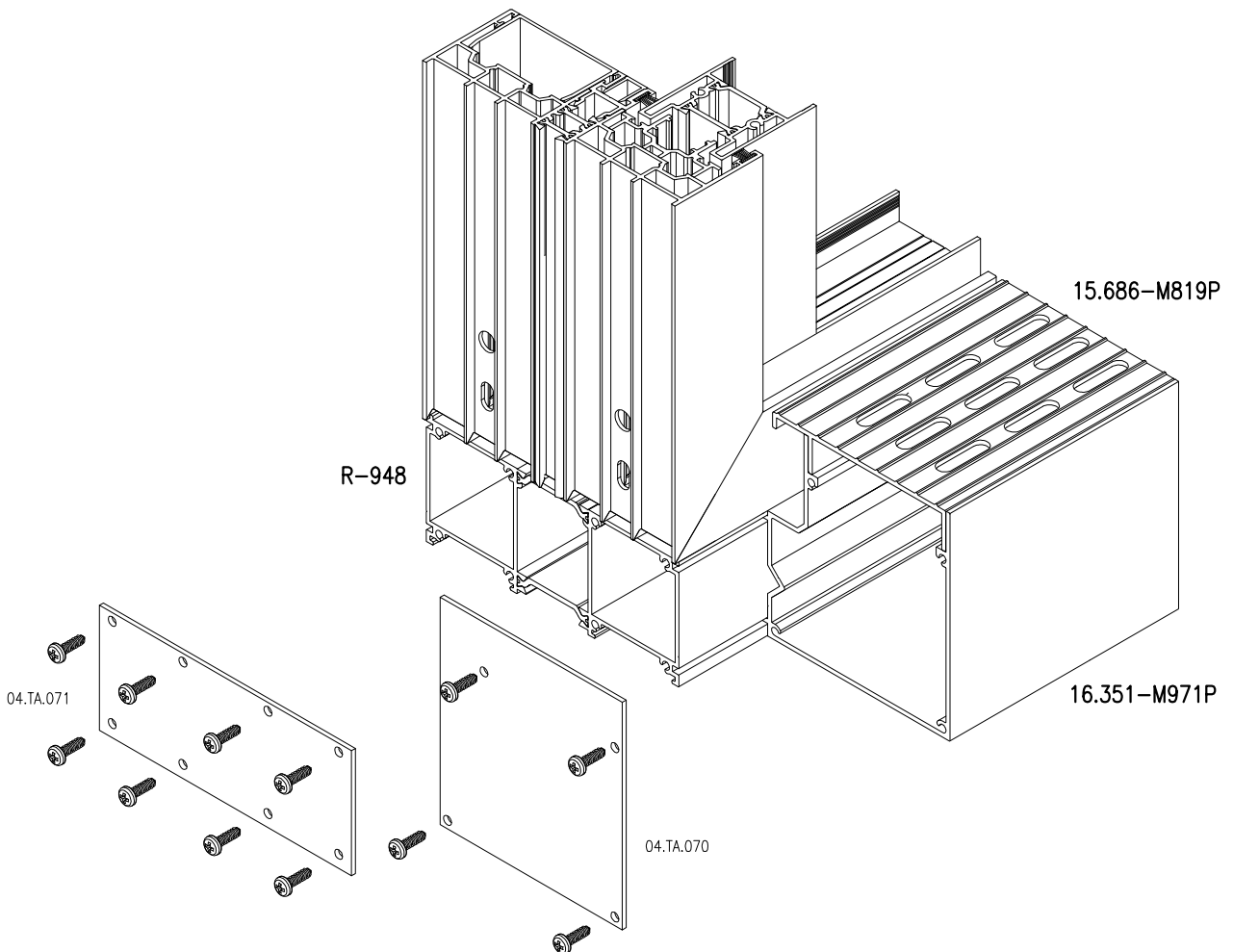
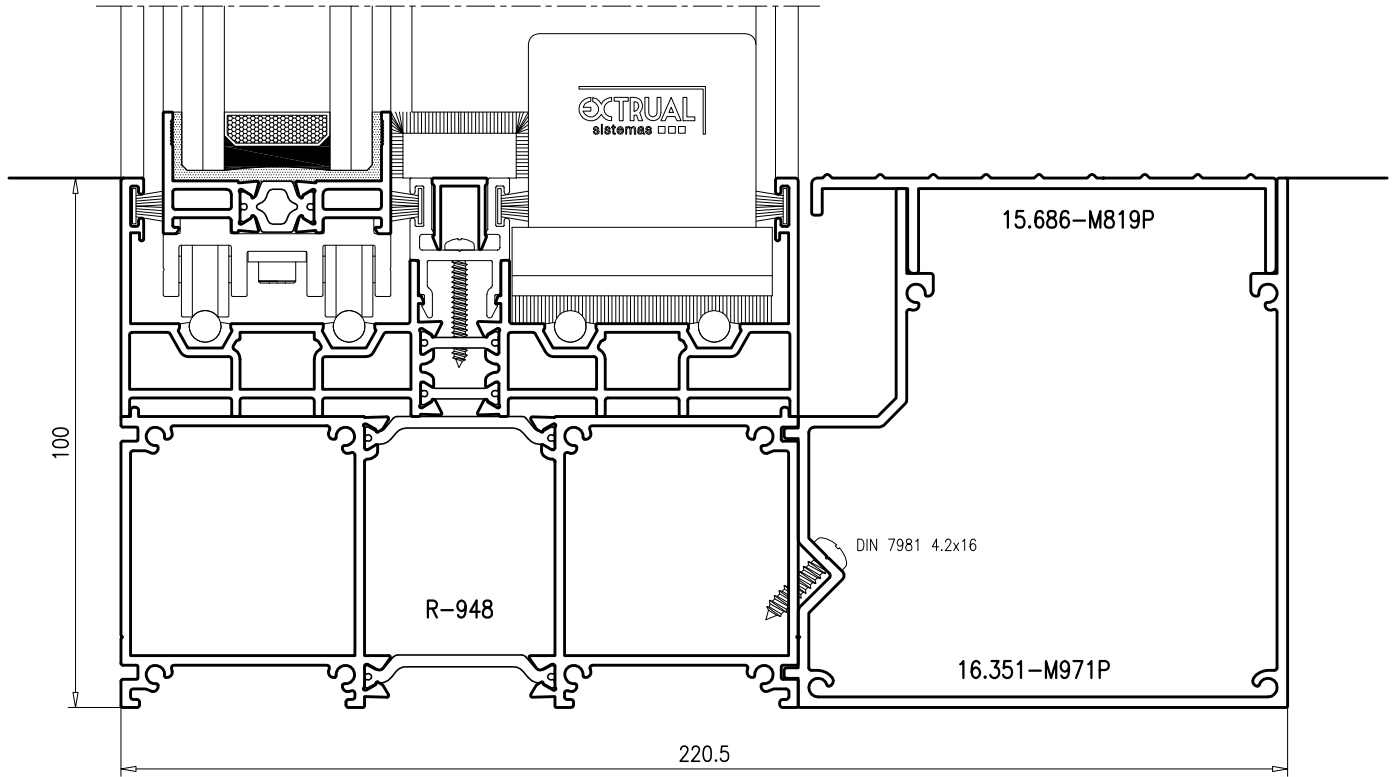

SECCION VERTICAL SOLERA Y CANAL DE DESAGUE Marco Inferior Oculto Tapas de Aluminio

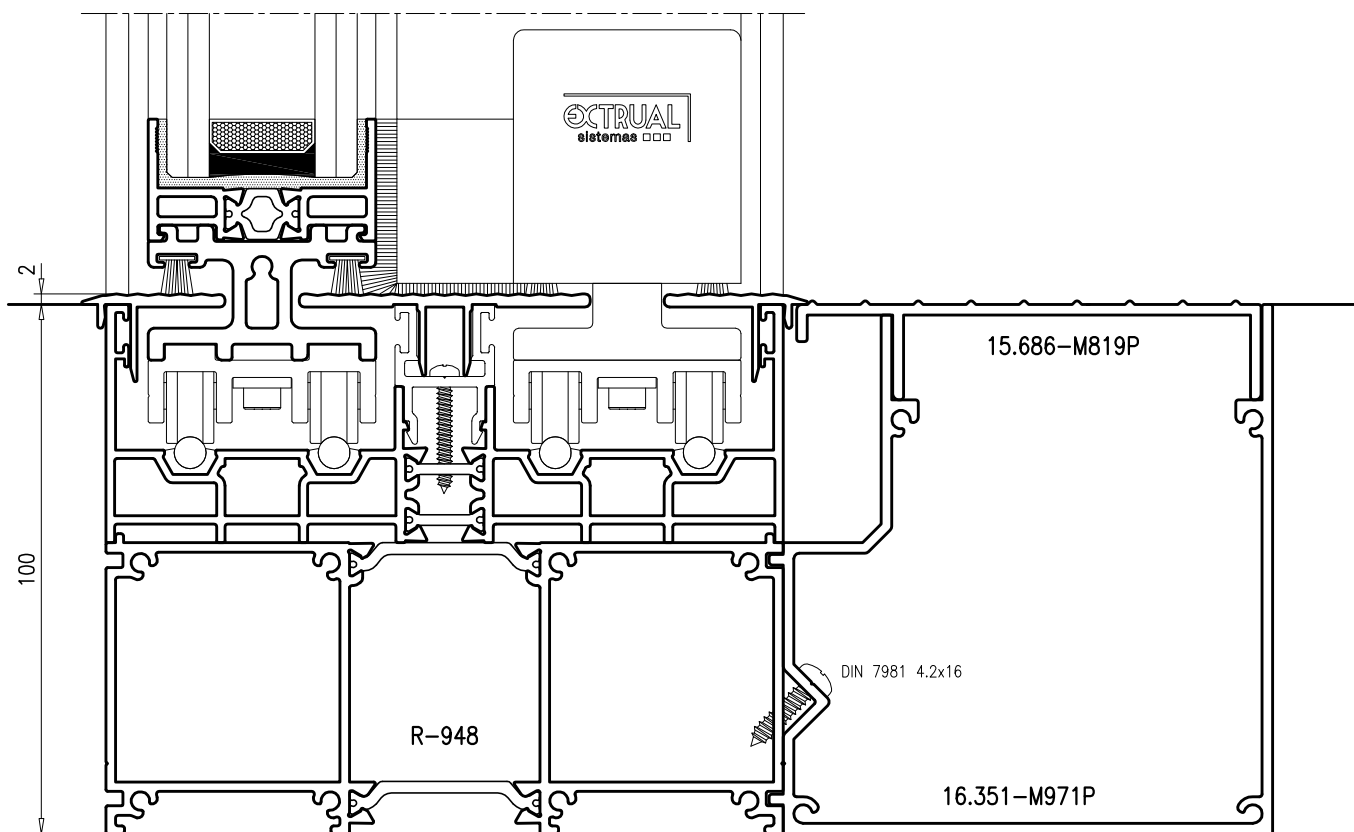

SECCION VERTICAL SOLERA Y CANAL DE DESAGUE Marco Inferior Oculto Piso Corrido

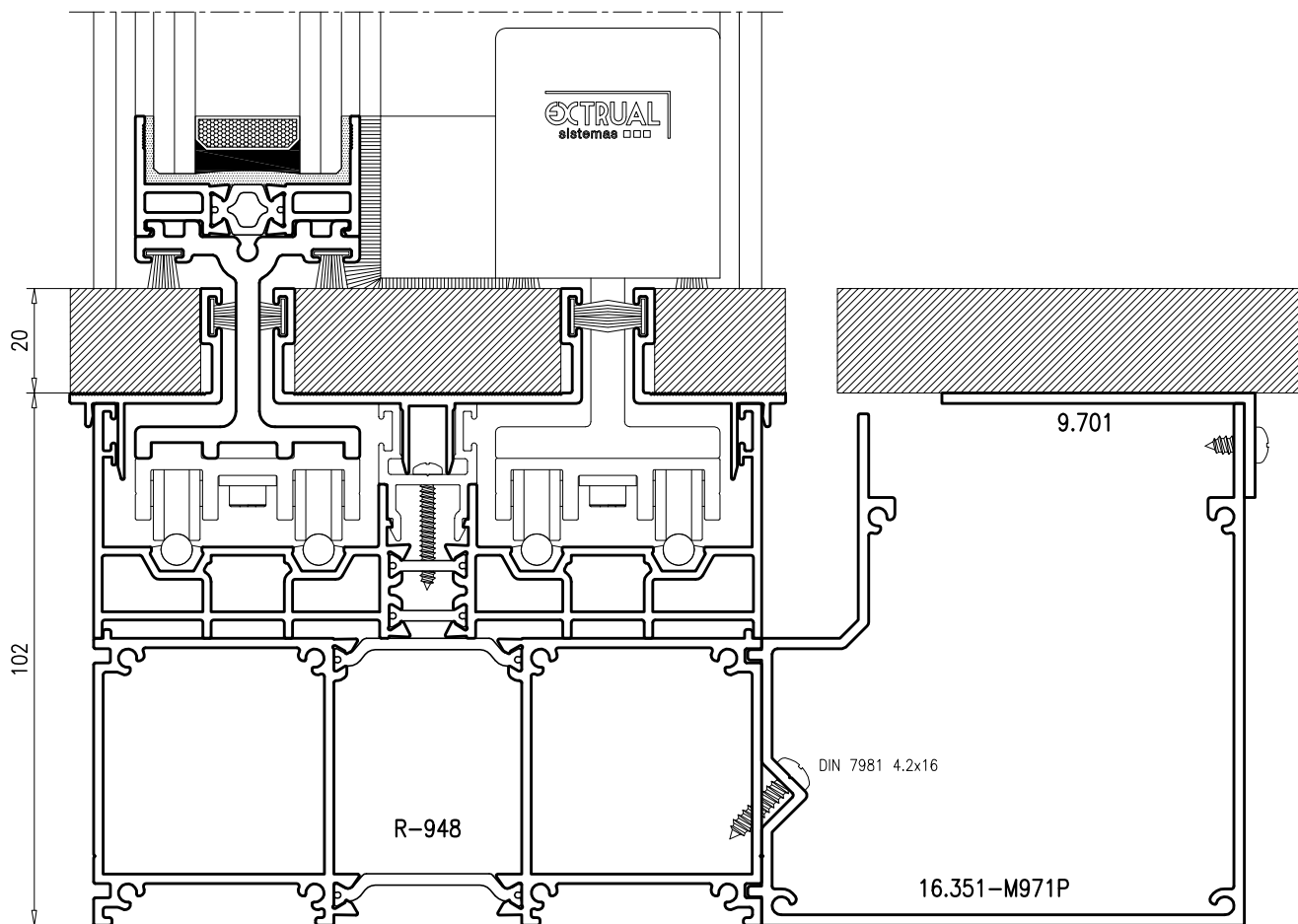

SECCION VERTICAL 1 HOJA + FIJO

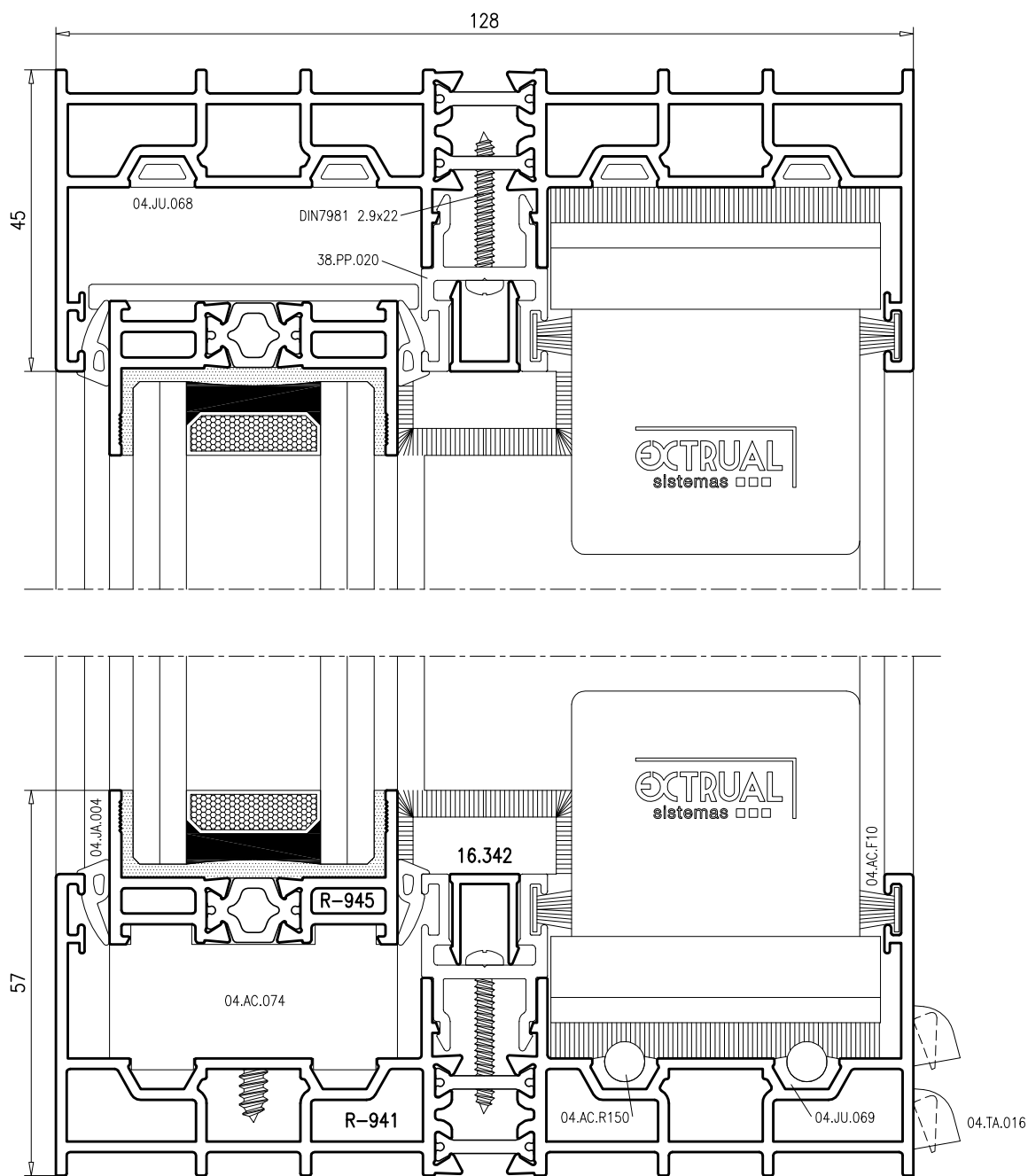
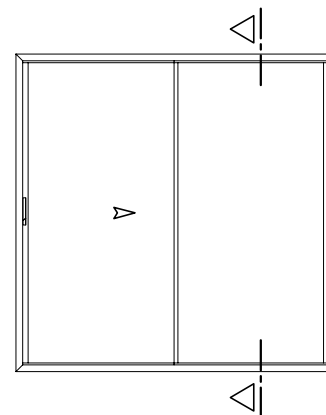

SECCION VERTICAL 2 HOJAS

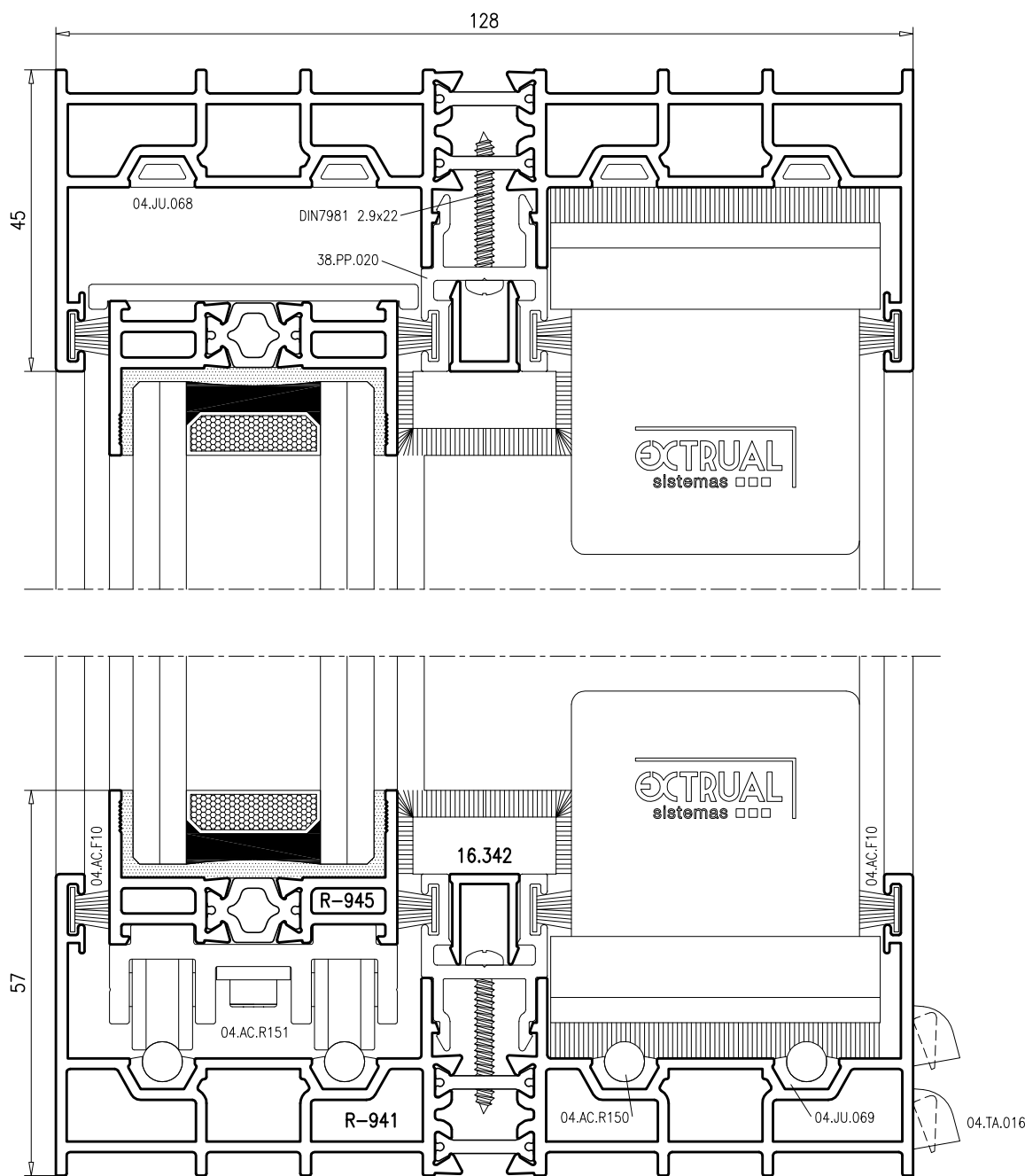
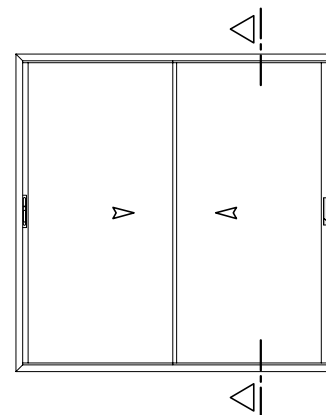

SECCION VERTICAL 1 HOJA + FIJO Marco Inferior Oculto Tapas de Aluminio

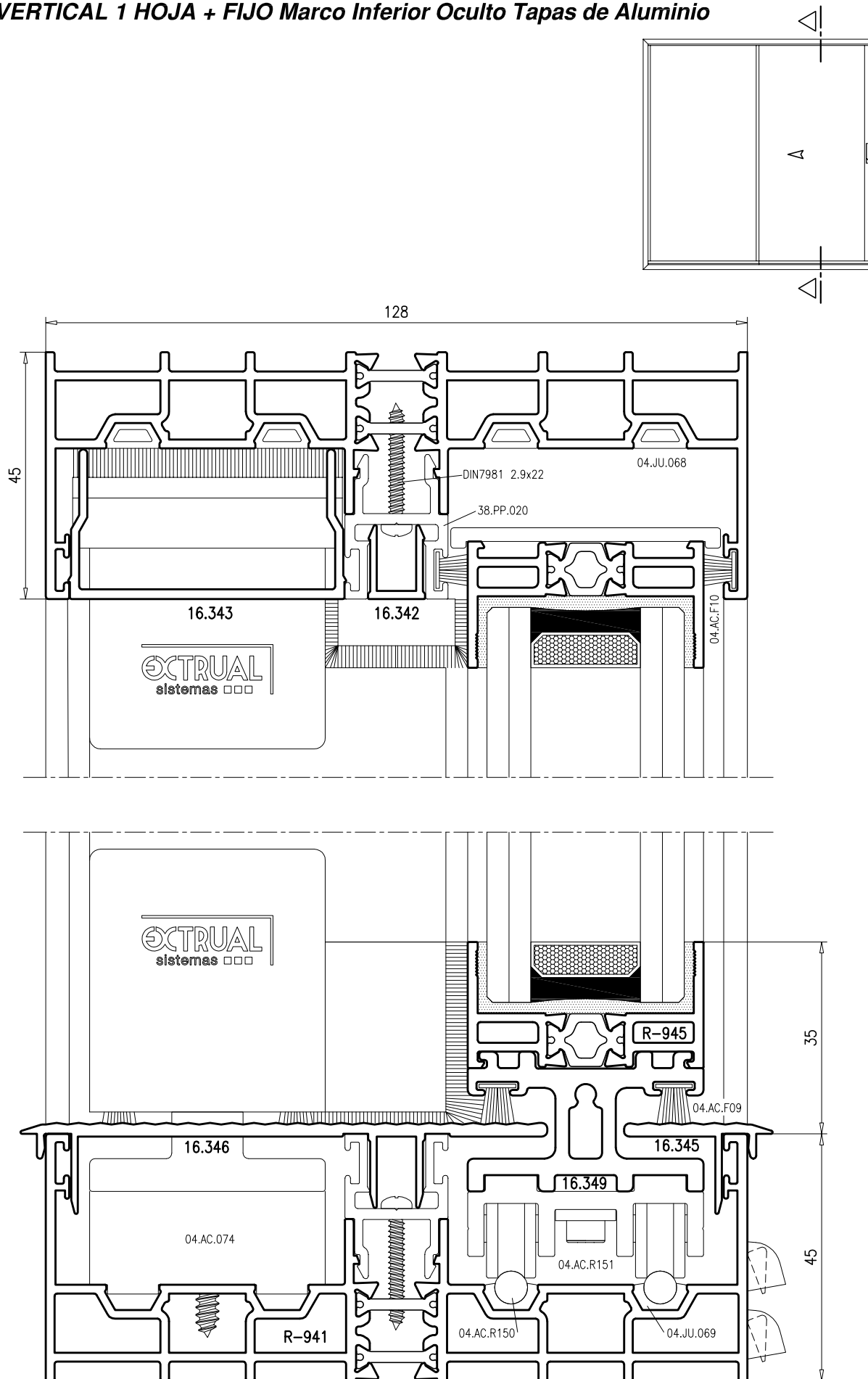

SECCION VERTICAL 2 HOJAS Marco Inferior Oculto Tapas de Aluminio

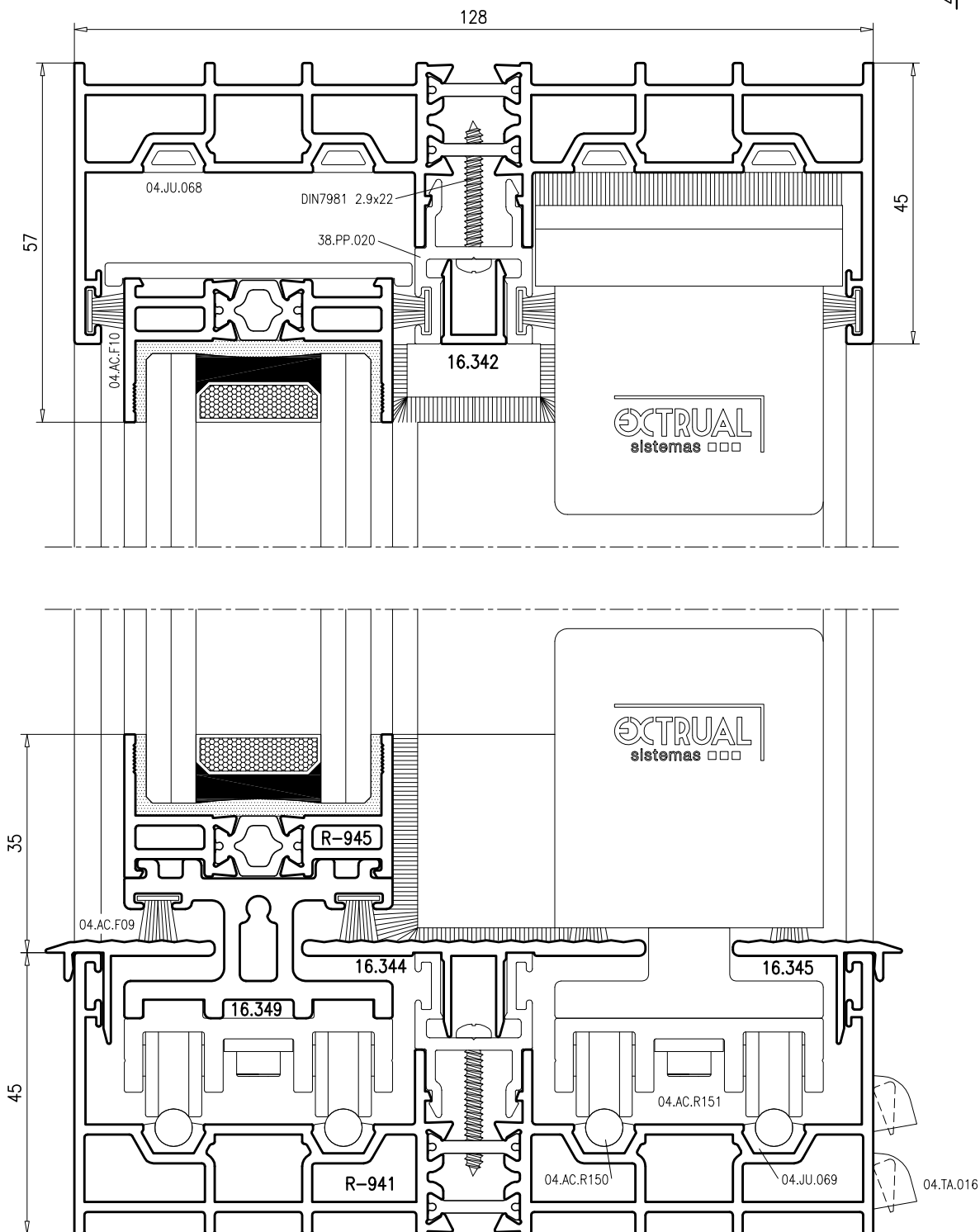
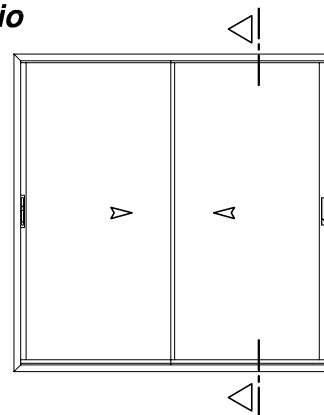

SECCION VERTICAL 1 HOJA + FIJO Marco Inferior Oculto Piso Corrido

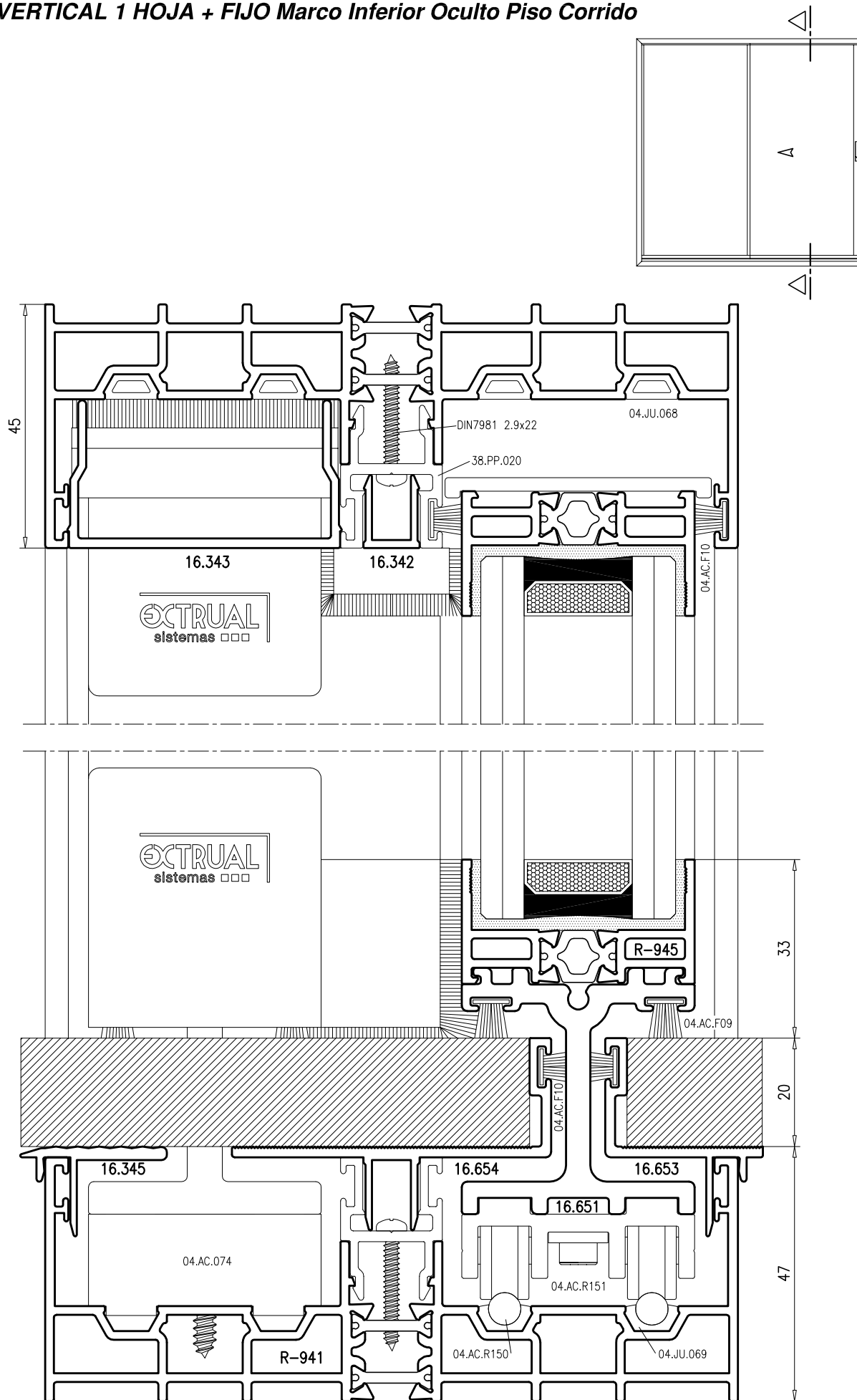

SECCION VERTICAL 2 HOJAS Marco Inferior Oculto Piso Corrido

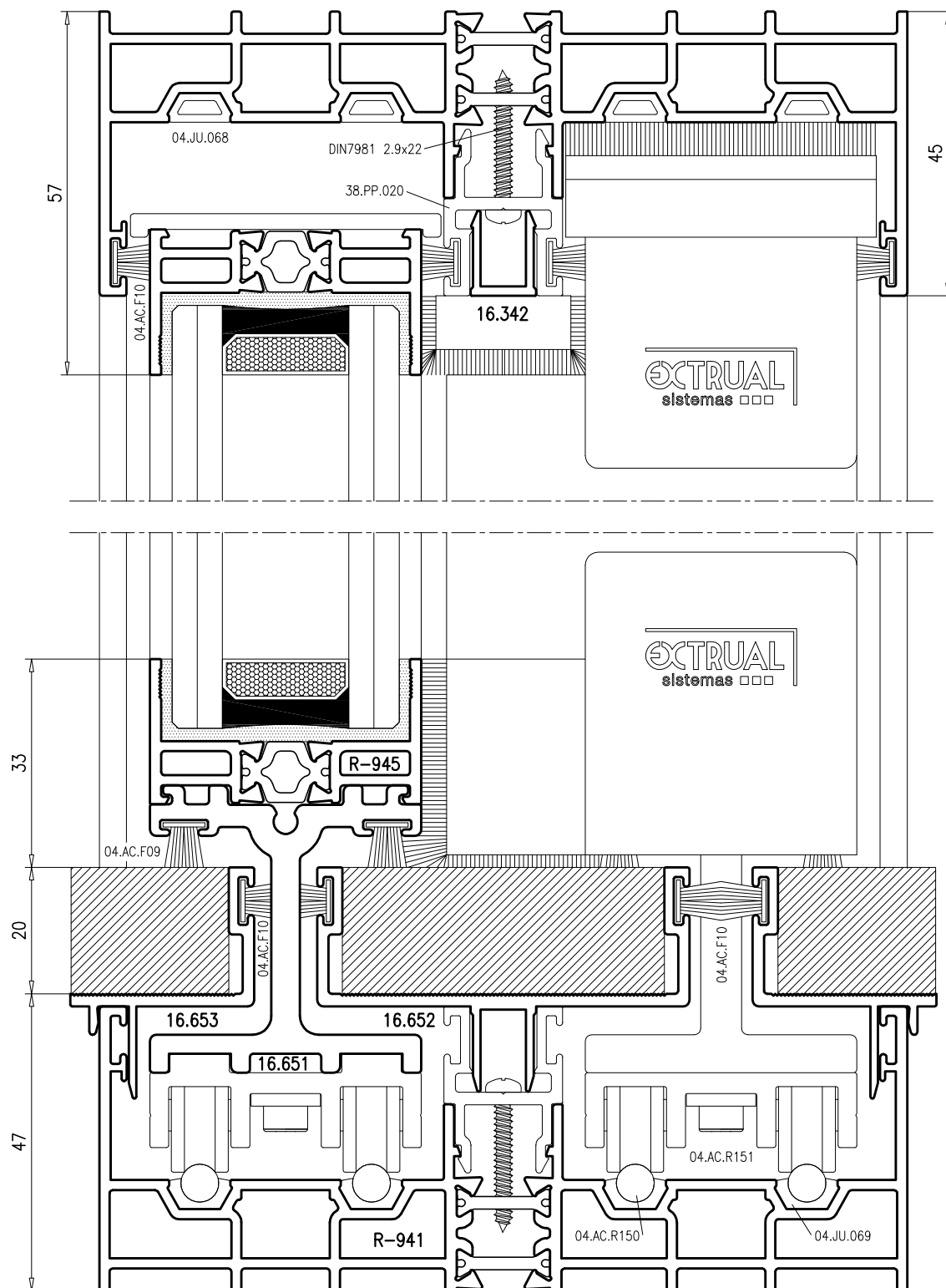
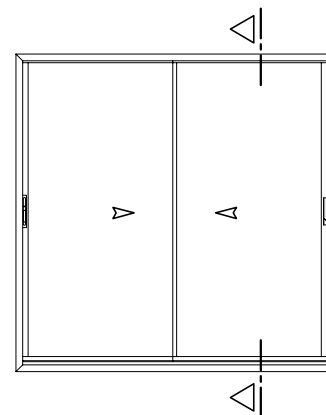

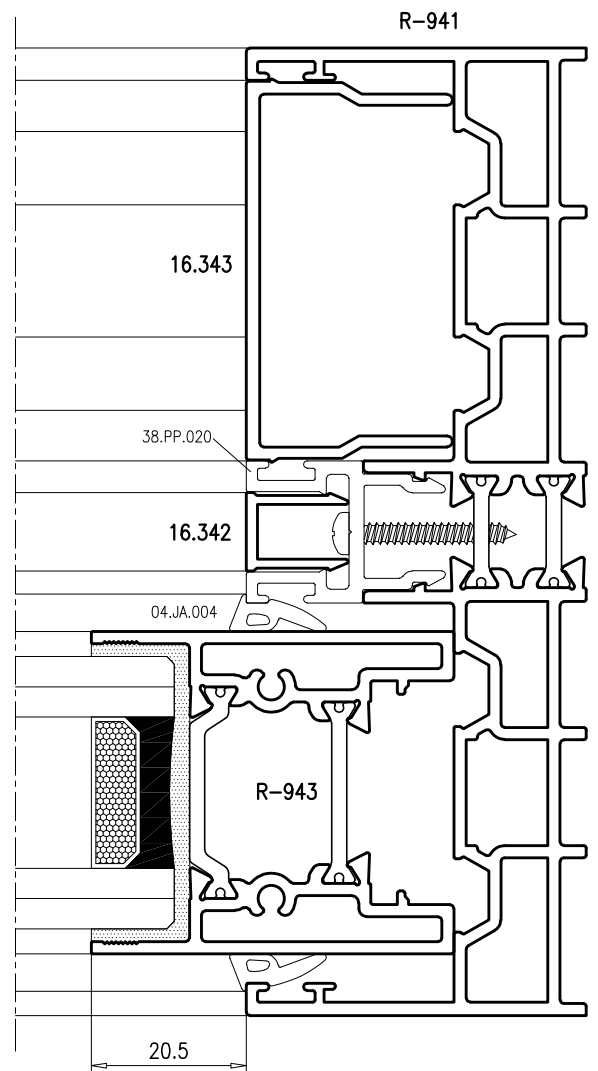
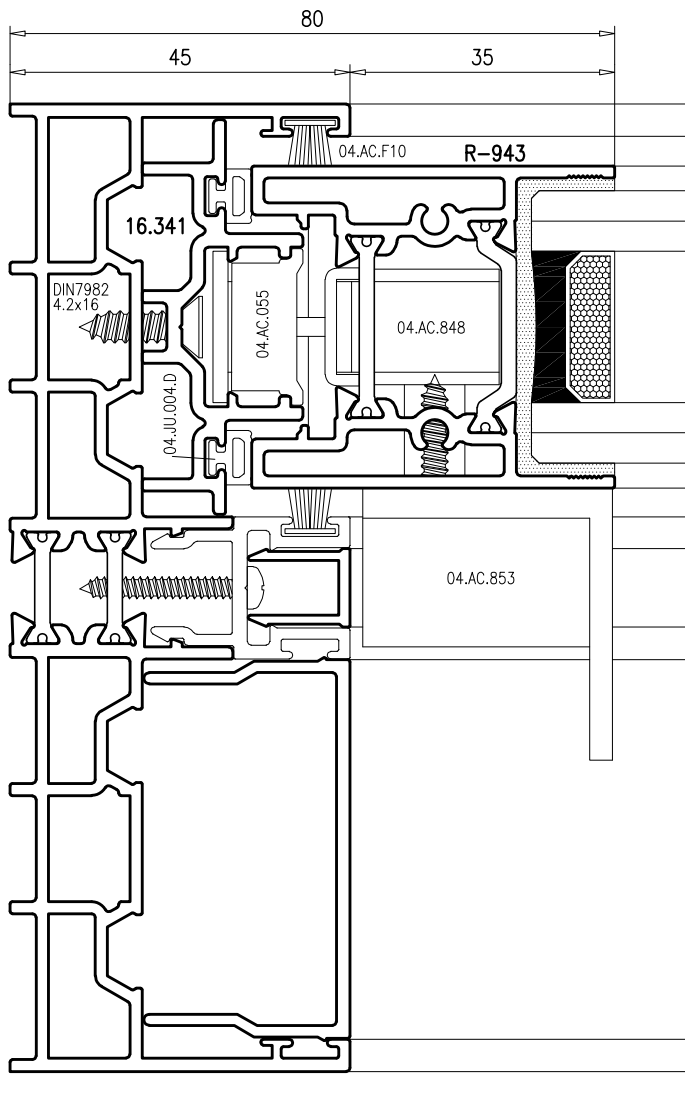
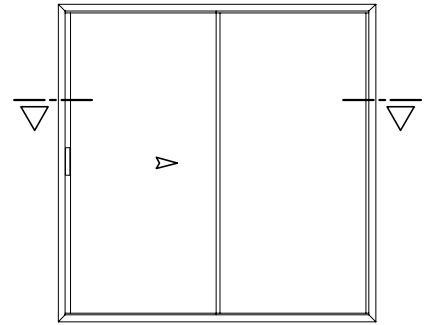
SECCION HORIZONTAL LATERAL 1 HOJA + FIJO

SECCION HORIZONTAL LATERAL 2 HOJAS

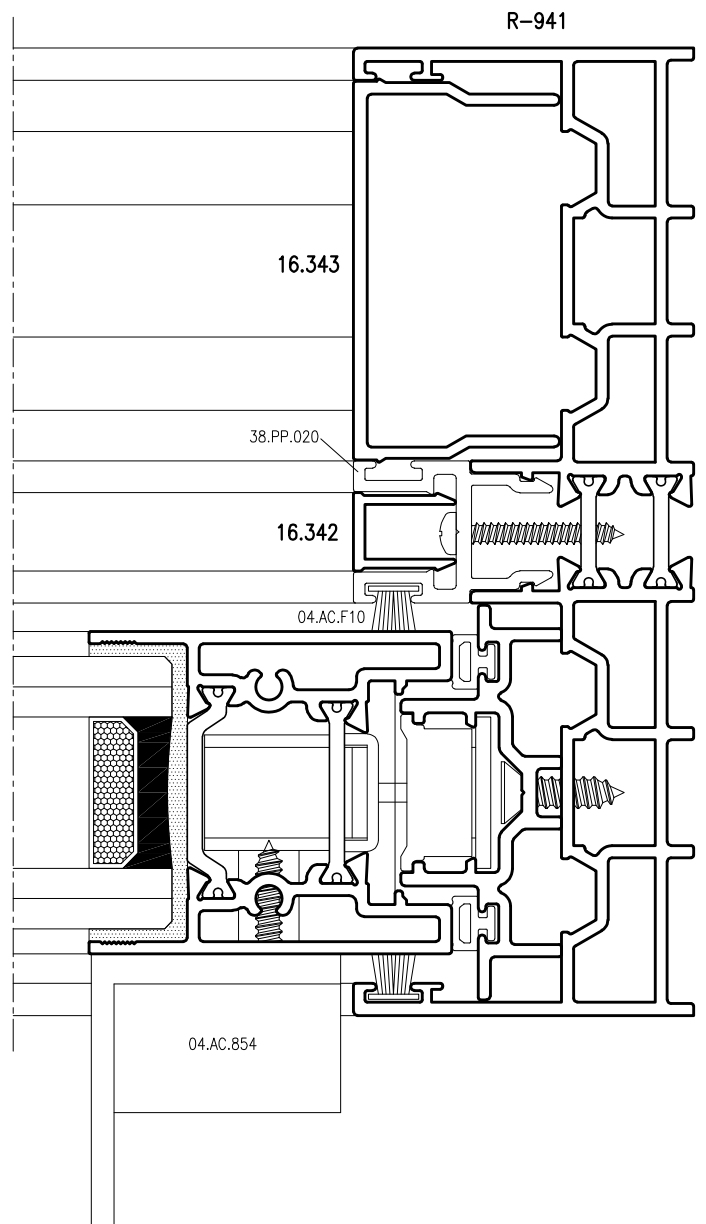
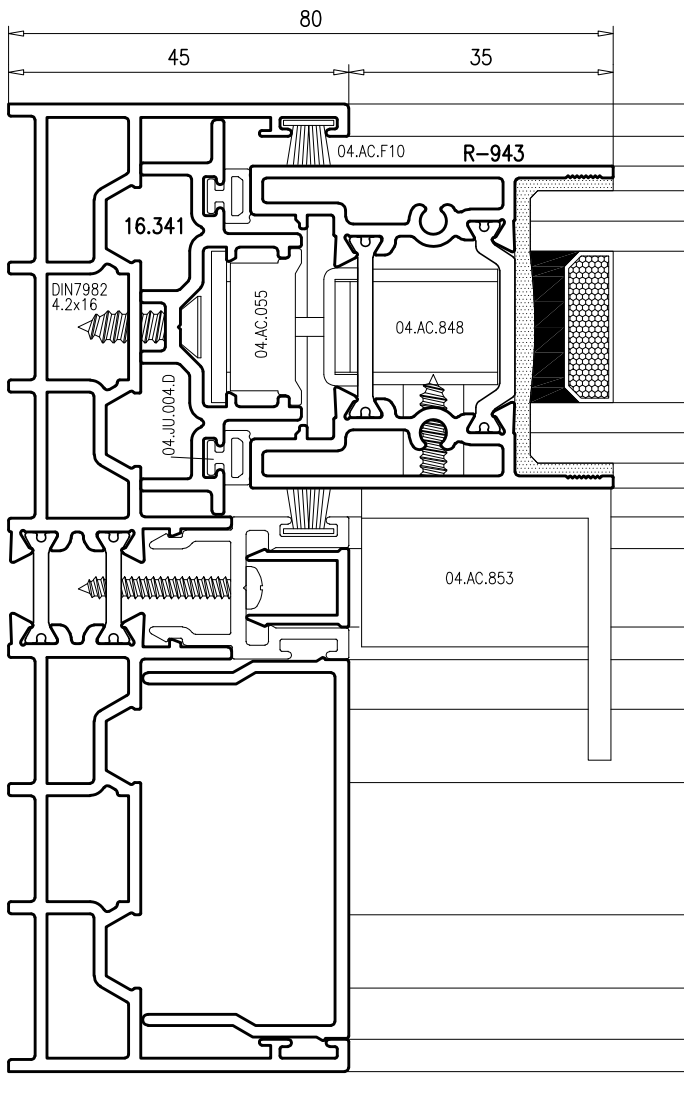
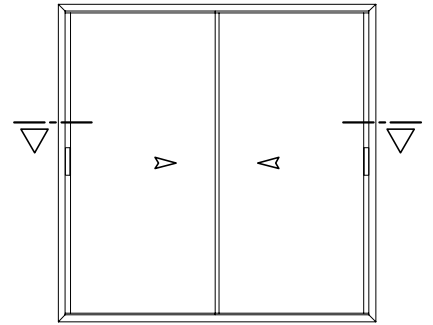

SECCION HORIZONTAL LATERAL Hoja Para Cremona con Llave

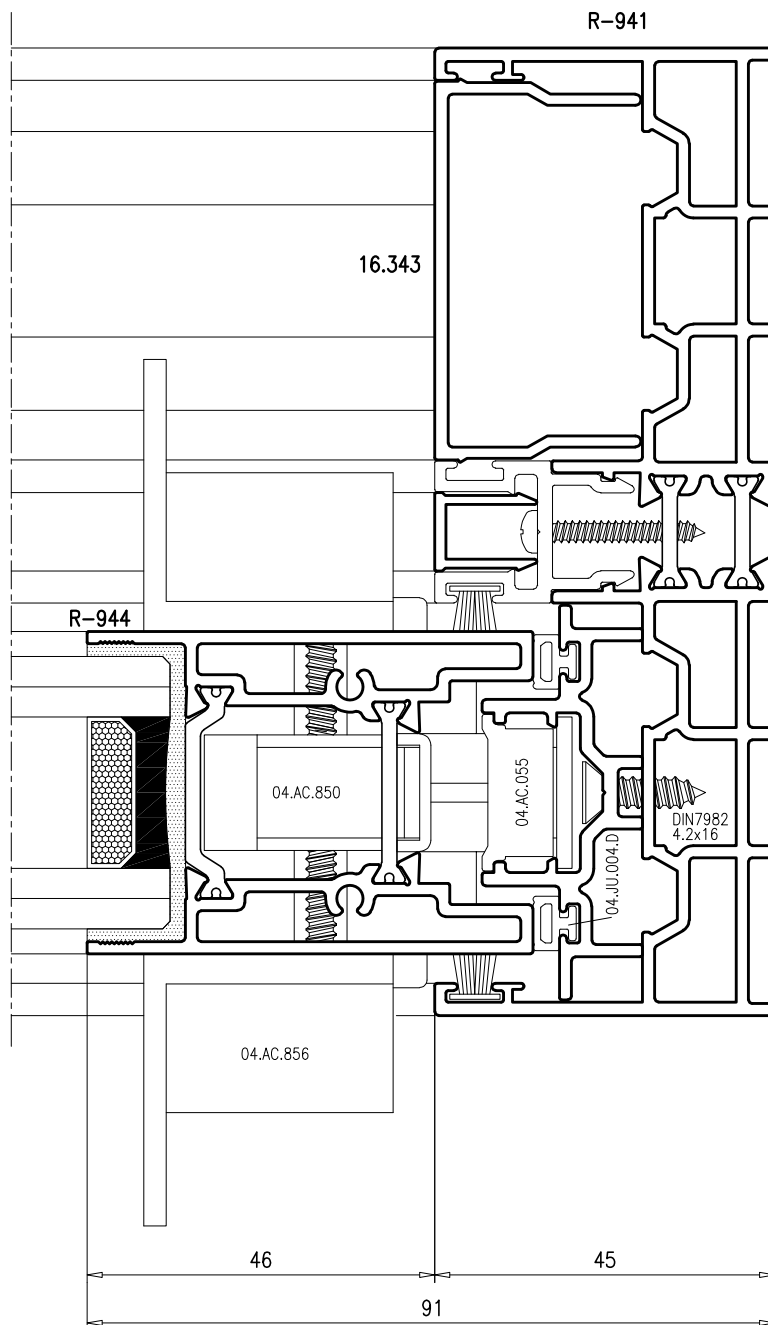
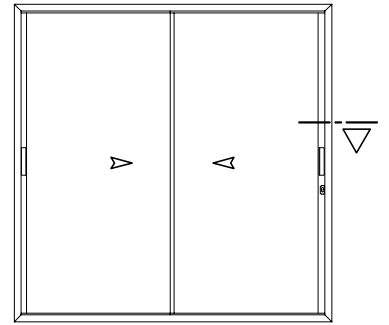

SECCION HORIZONTAL CENTRAL

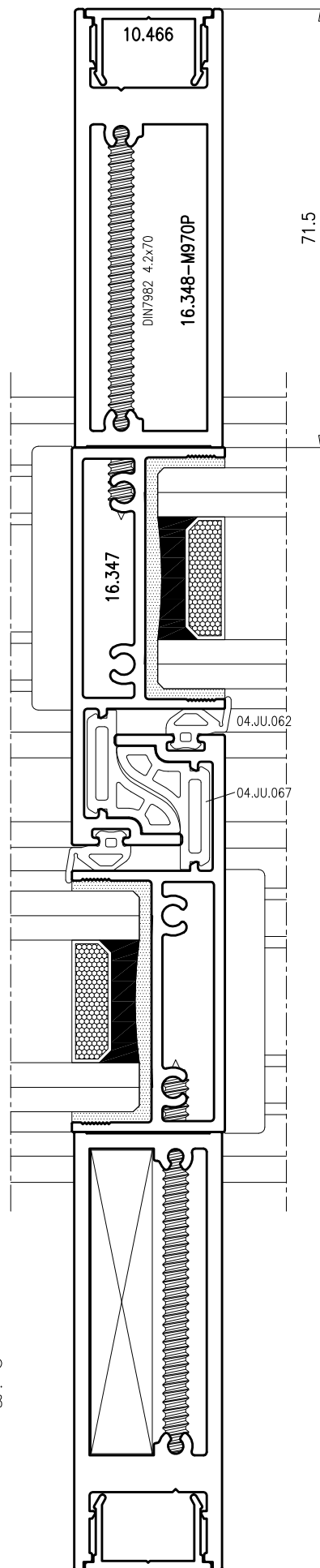
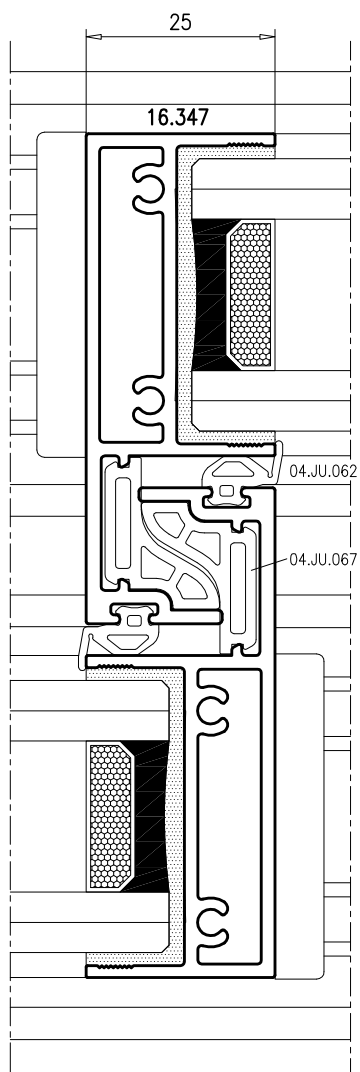
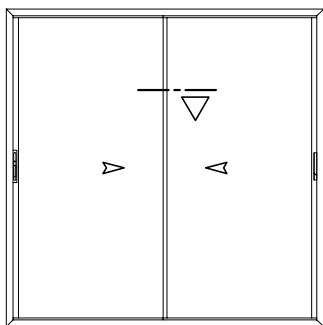

Para mejorar la Inercia del conjunto se introduce una pletina de acero Inox. de 50x10 en el interior del perfil 16.348

SECCION HORIZONTAL CENTRAL (Hoja Invertida)

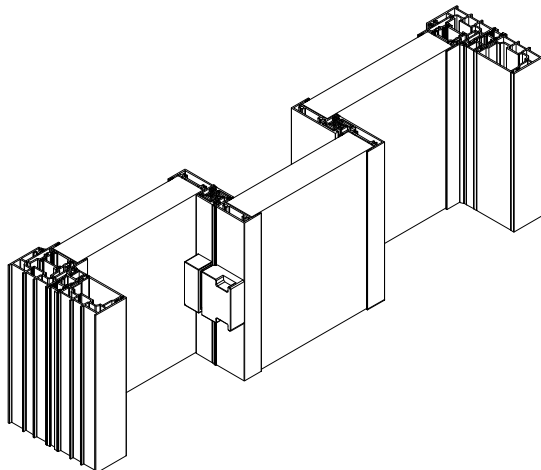
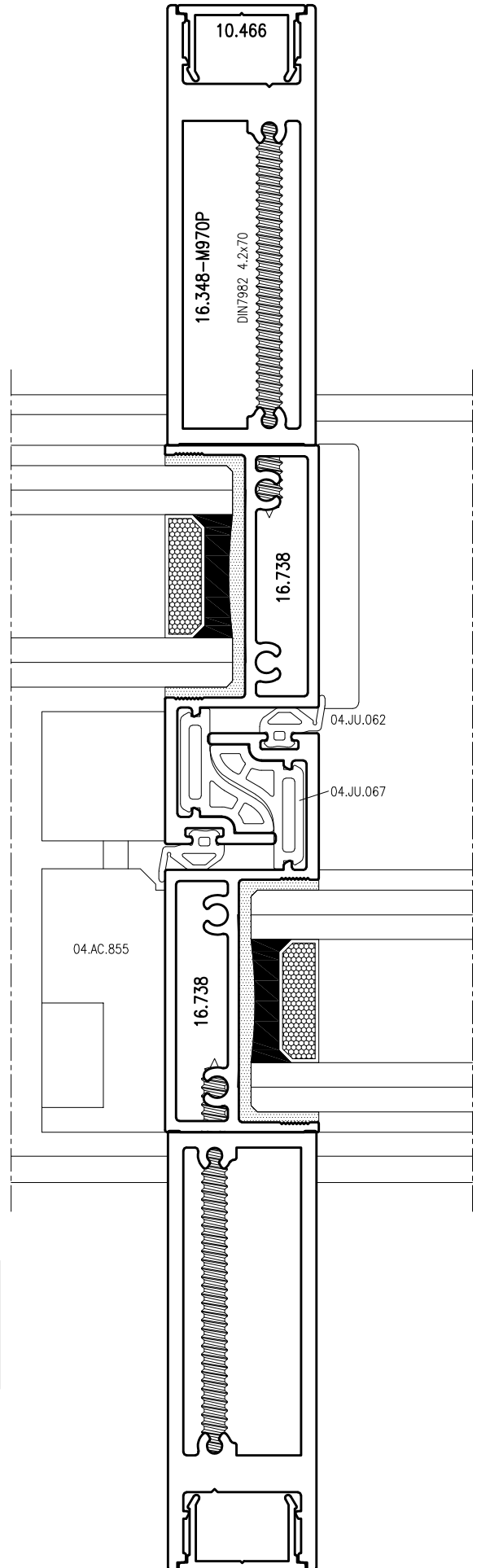
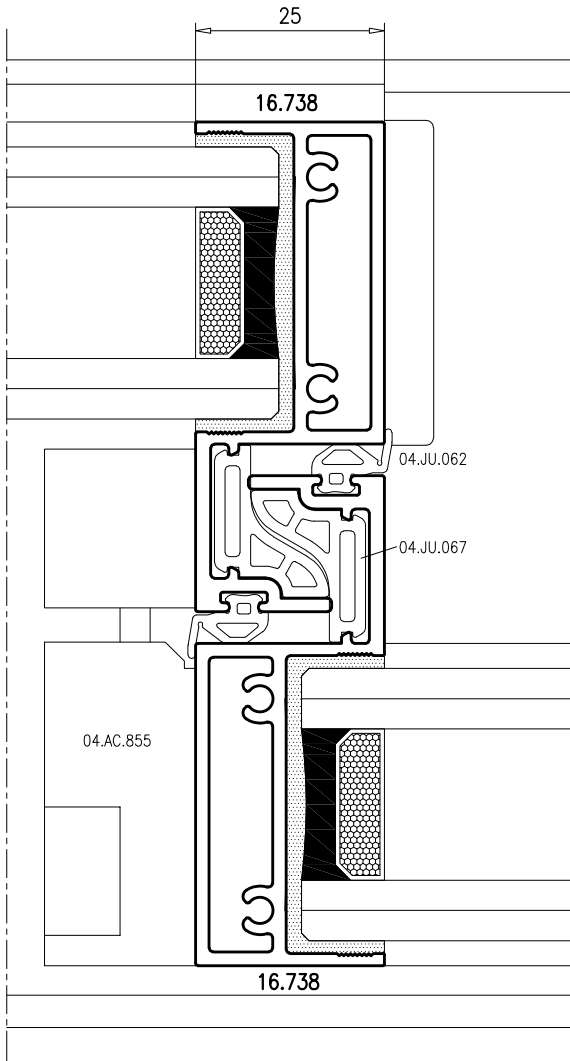
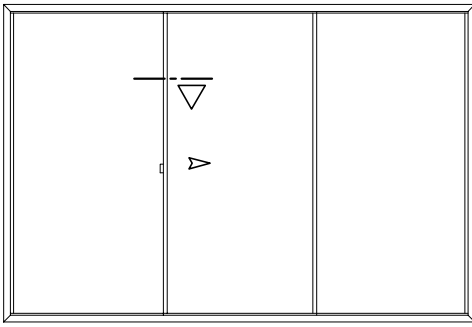

SECCION HORIZONTAL CENTRAL 4 Hojas

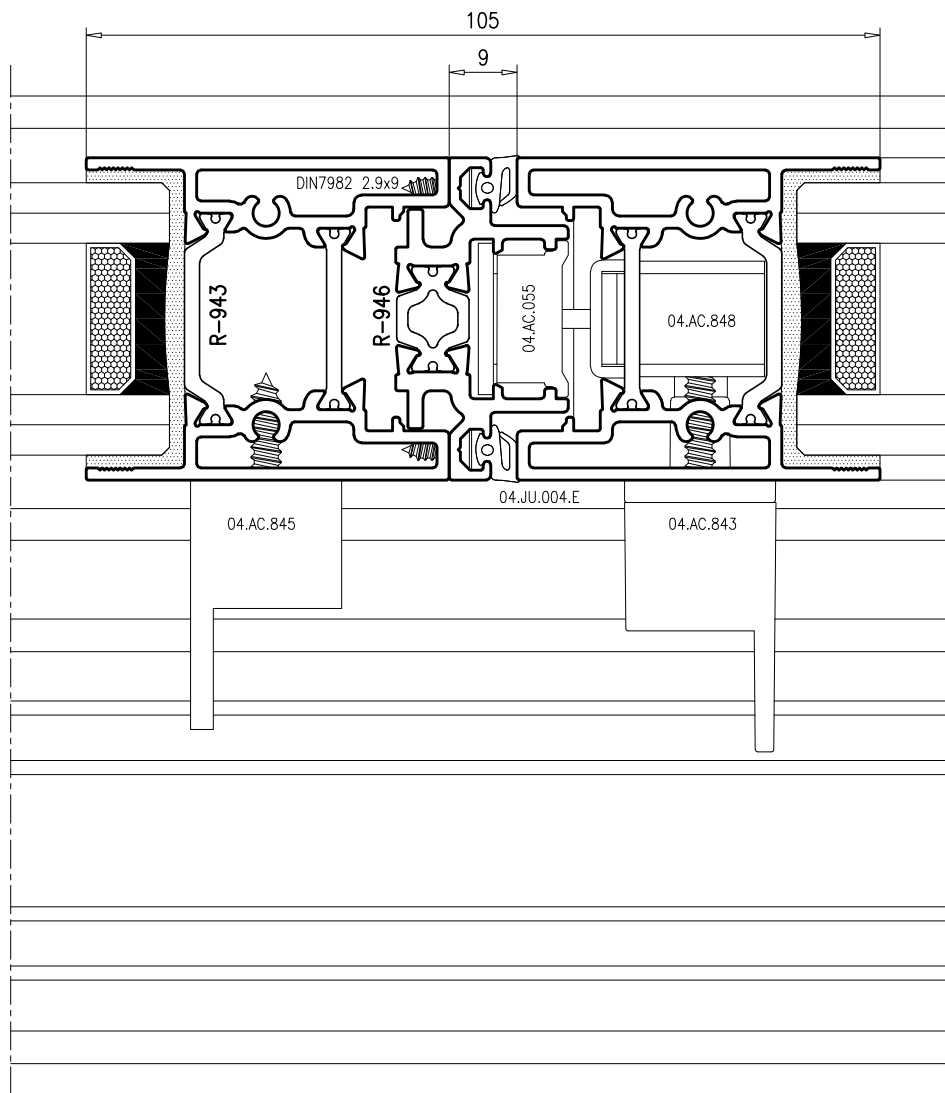
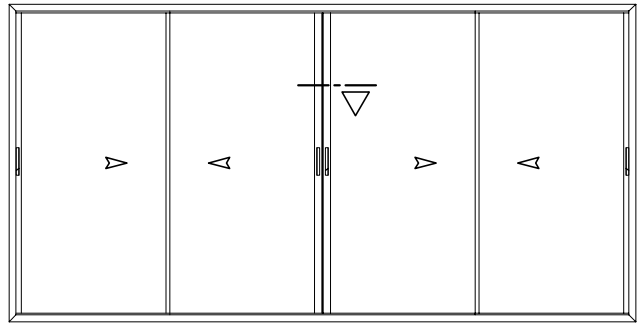

SECCION HORIZONTAL CENTRAL 4 Hojas Reforzada

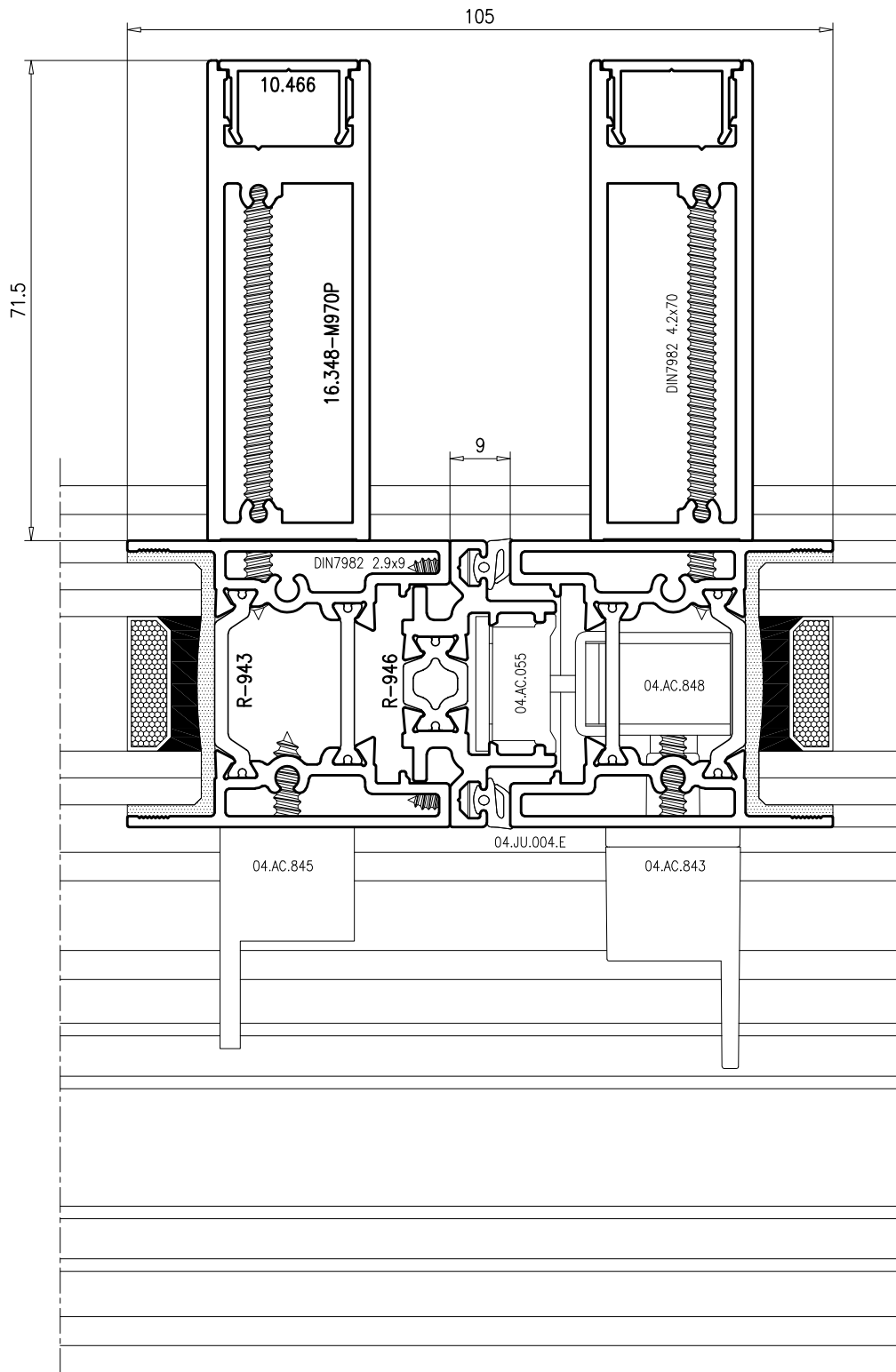
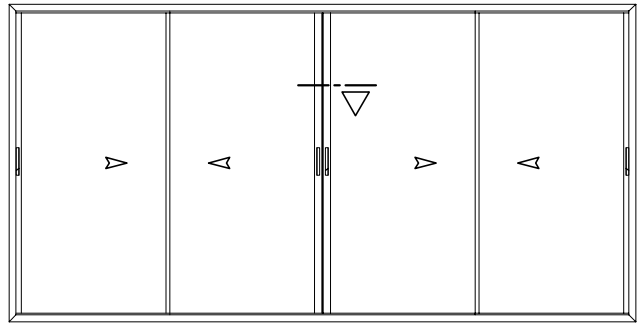

SECCION VERTICAL 1 HOJA ENTREMUROS

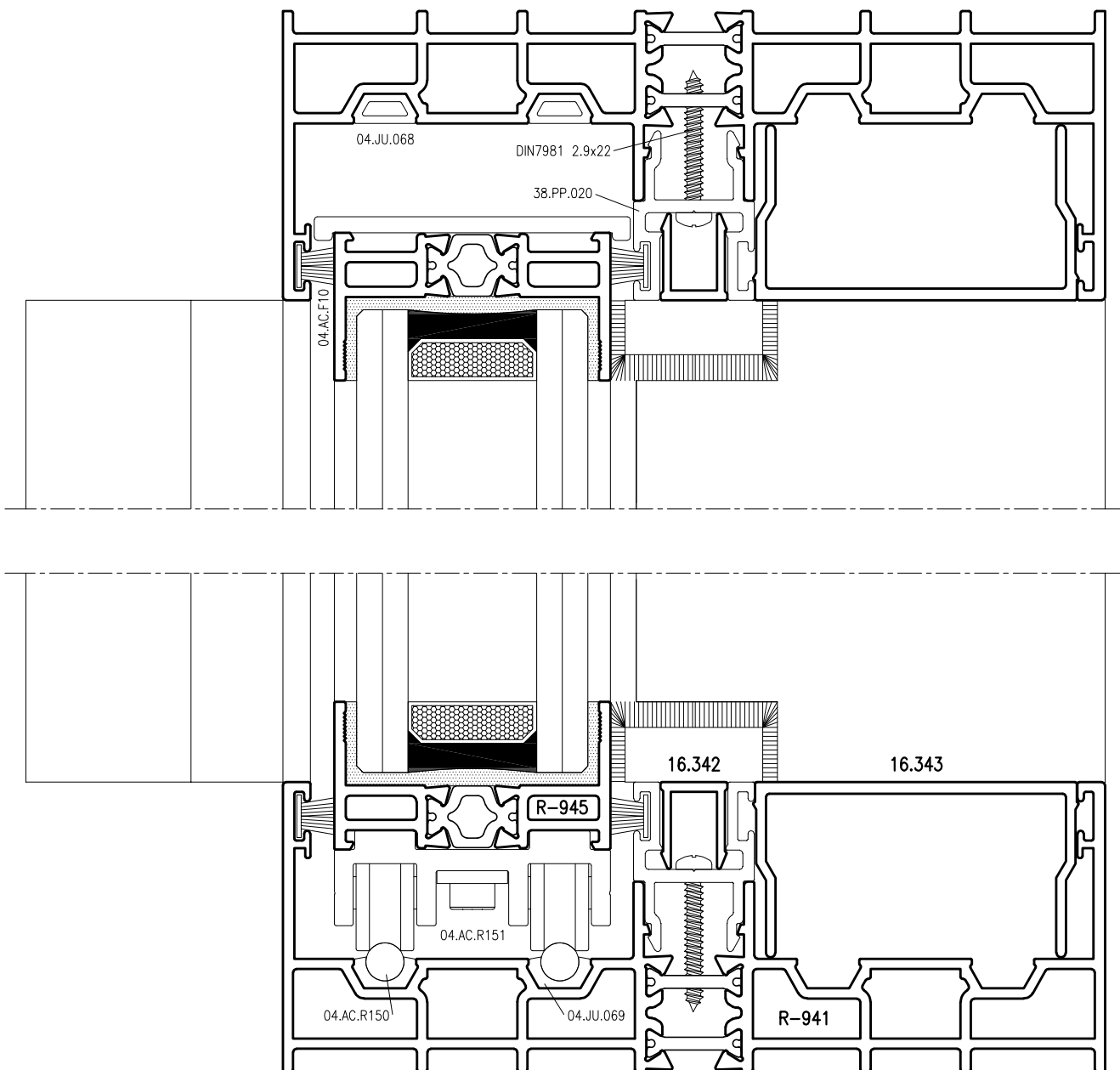
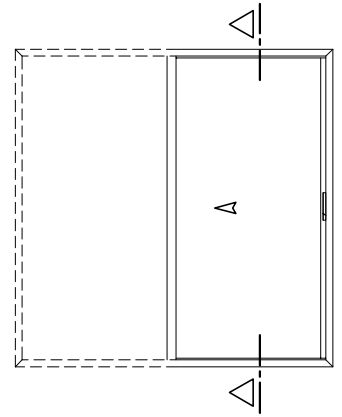

SECCION VERTICAL 1 HOJA ENTREMUROS Marco Inferior Oculto Tapas de Aluminio

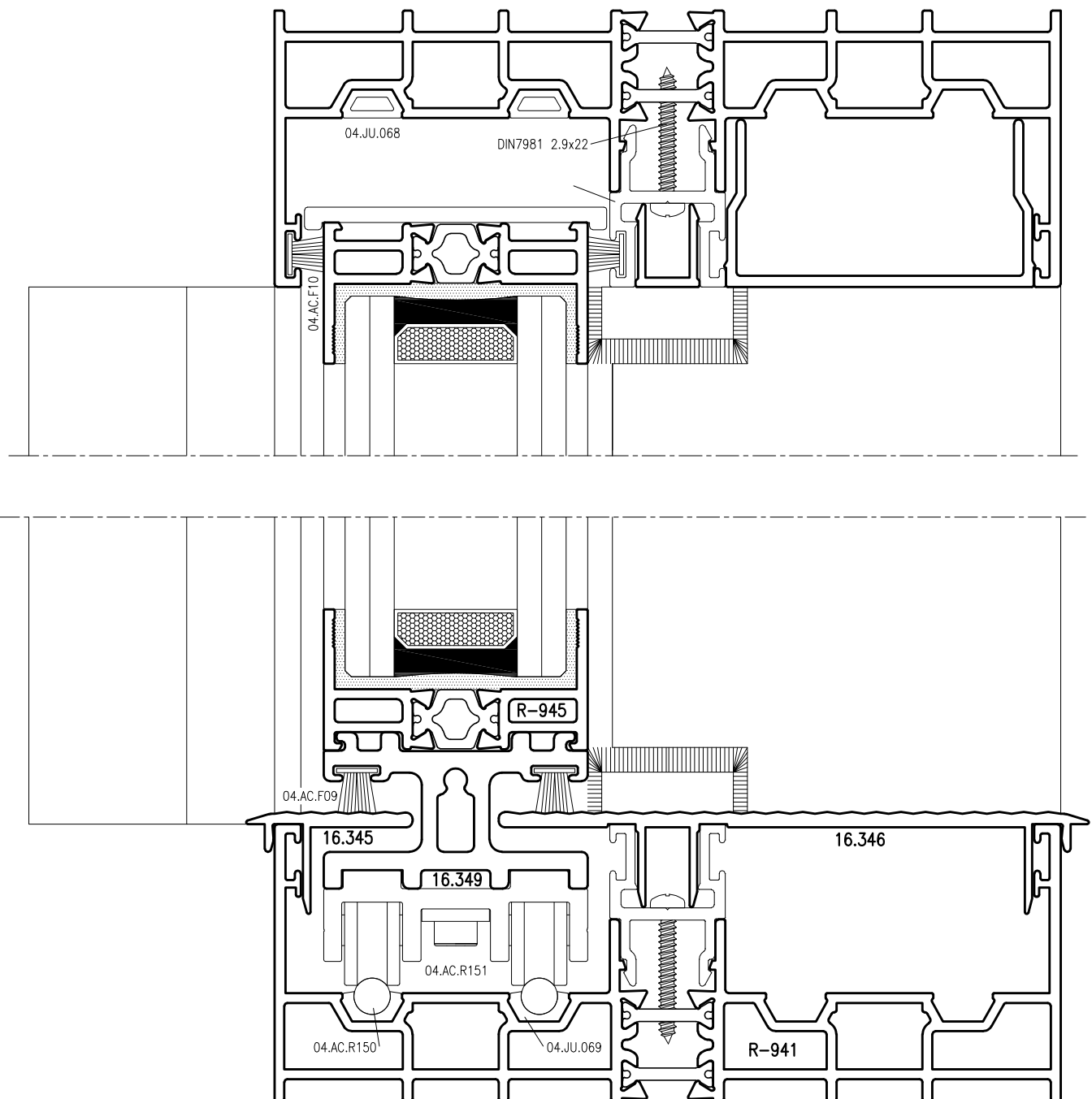
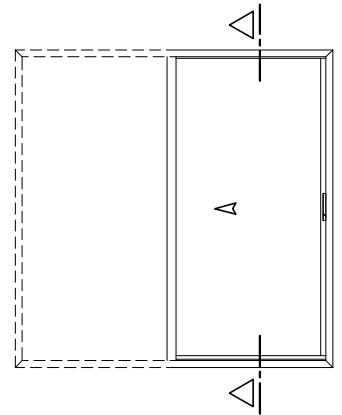

SECCION VERTICAL 1 HOJA ENTREMUROS Marco Inferior Oculto Piso Corrido

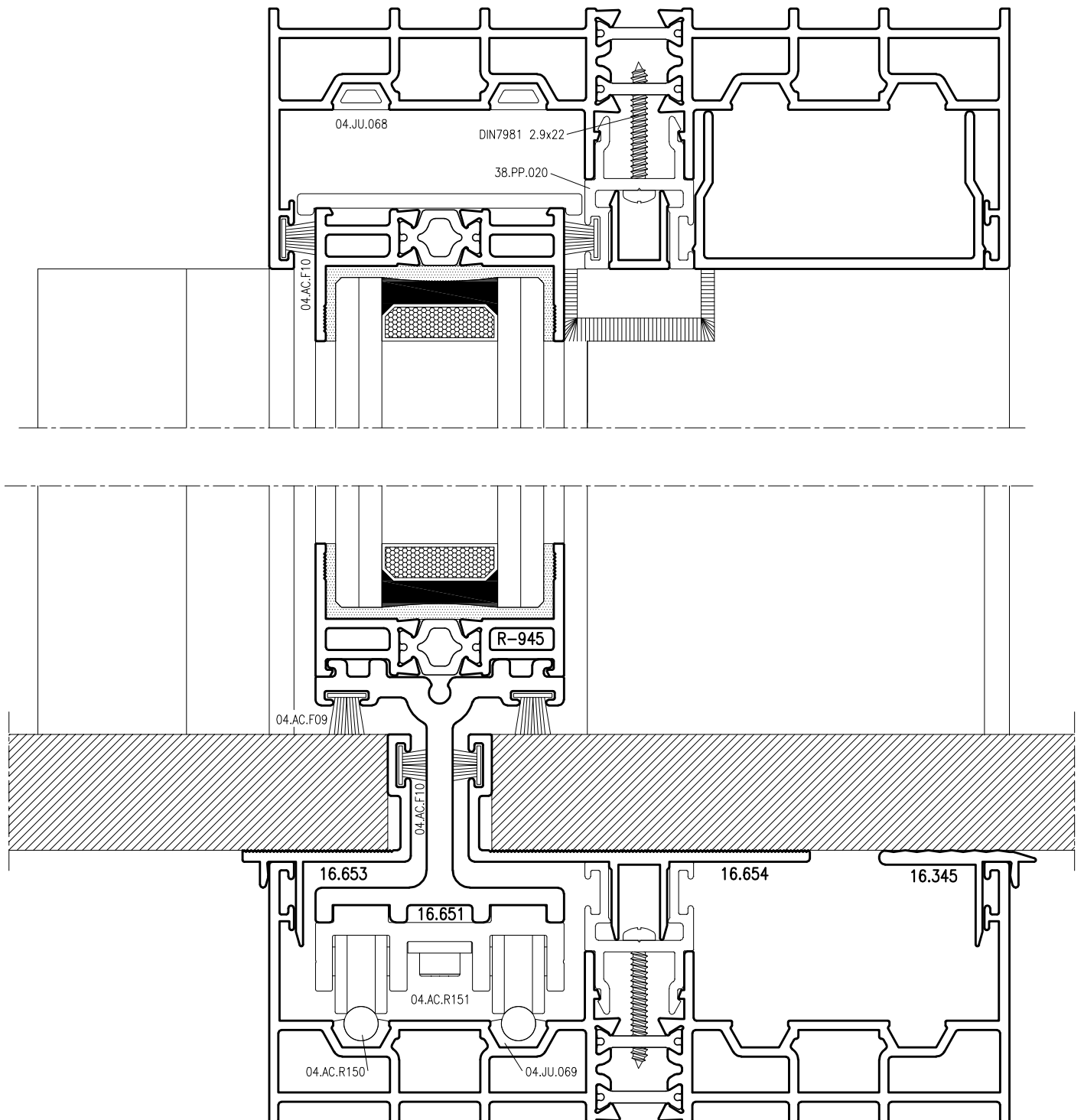
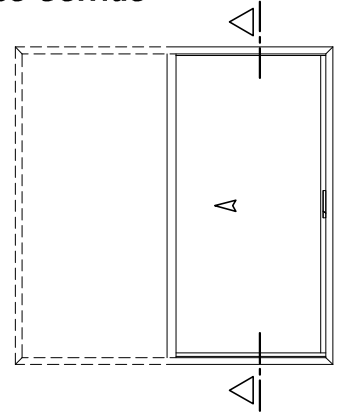

SECCION HORIZONTAL 1 HOJA ENTREMUROS

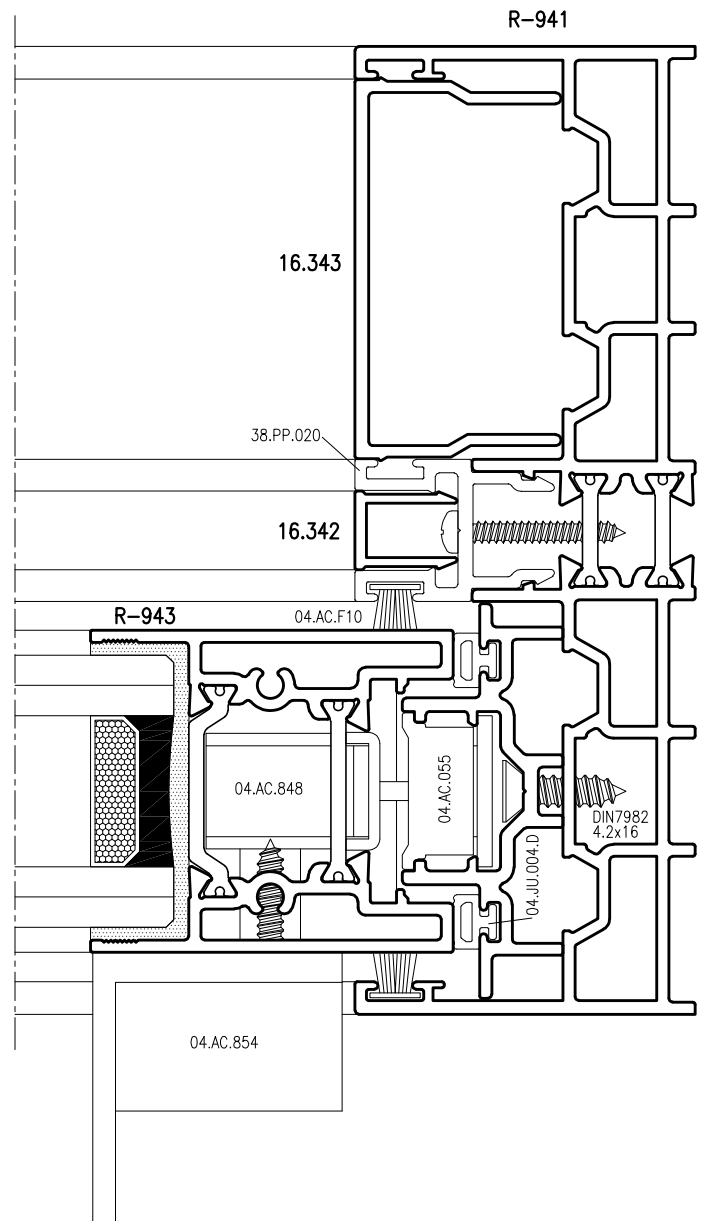
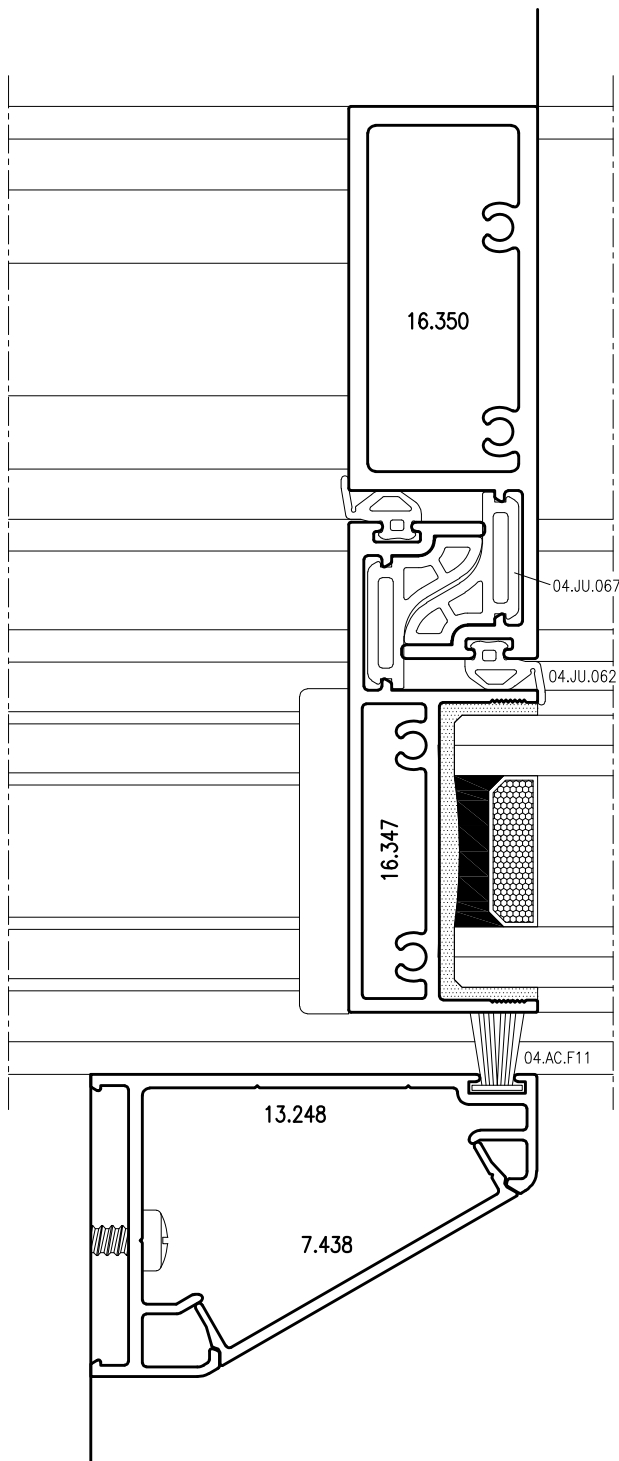
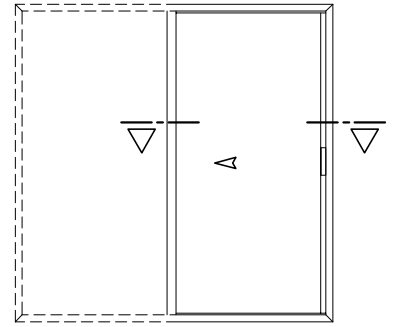

SECCION VERTICAL 2 HOJAS ENTREMUROS

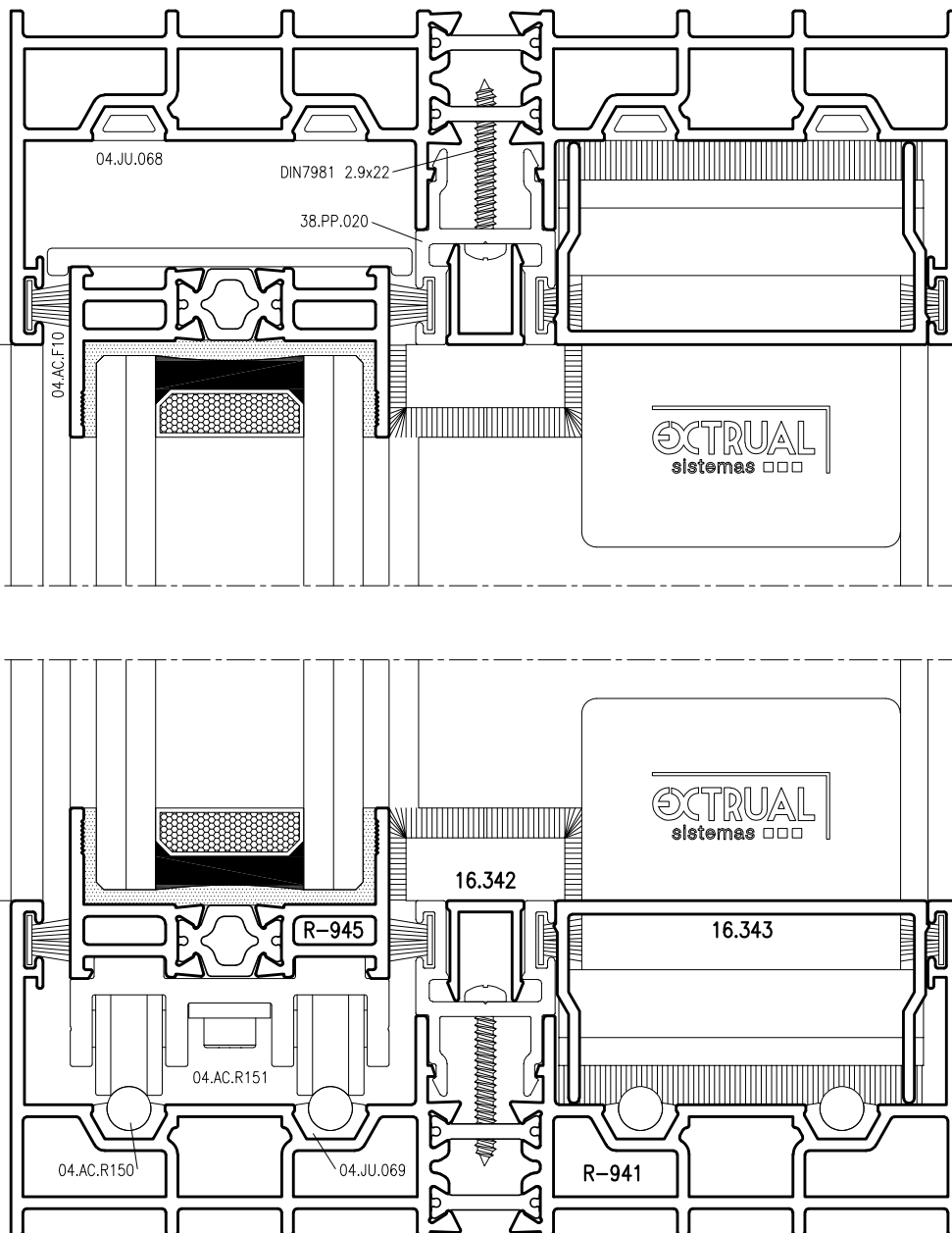
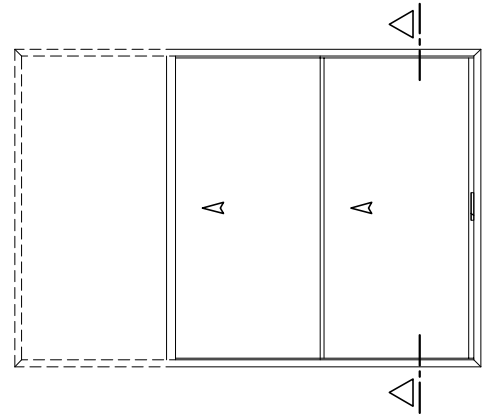

SECCION VERTICAL 2 HOJAS ENTREMUROS Marco Inferior Oculto Tapas de Aluminio

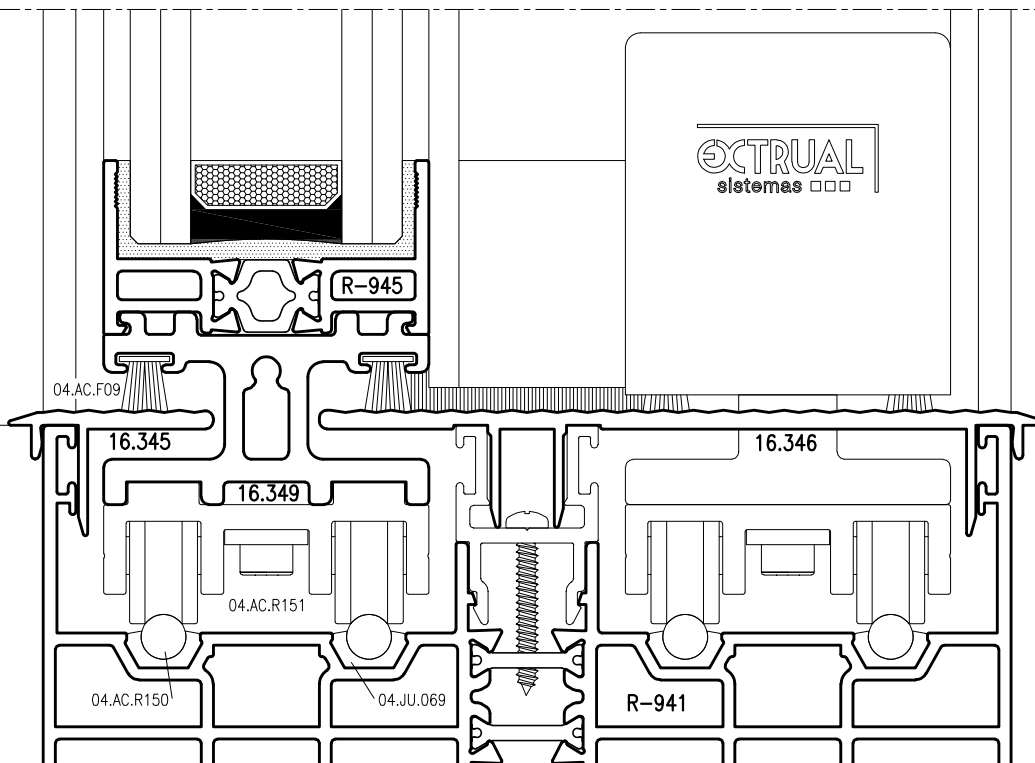
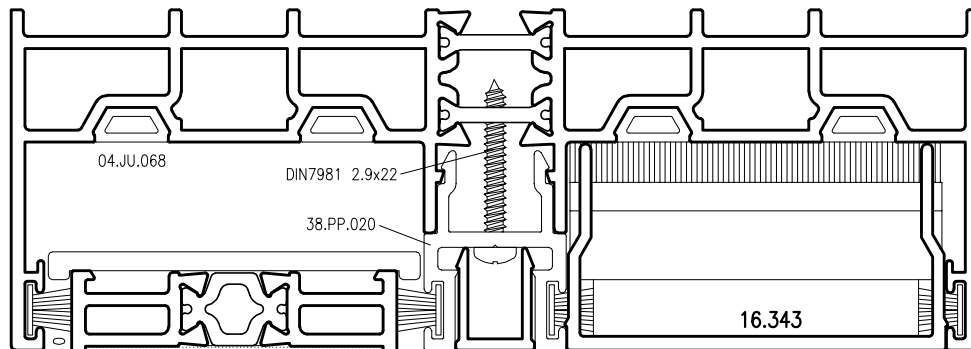
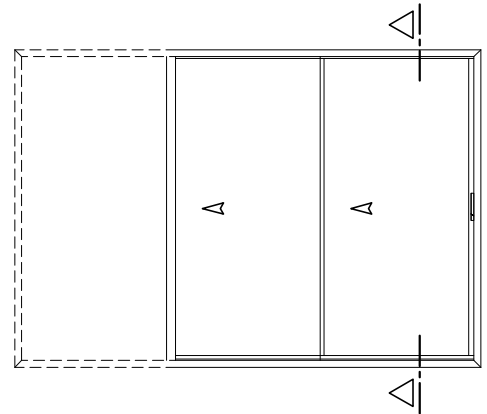

SECCION VERTICAL 2 HOJAS ENTREMUROS Marco Inferior Oculto Piso Oculto

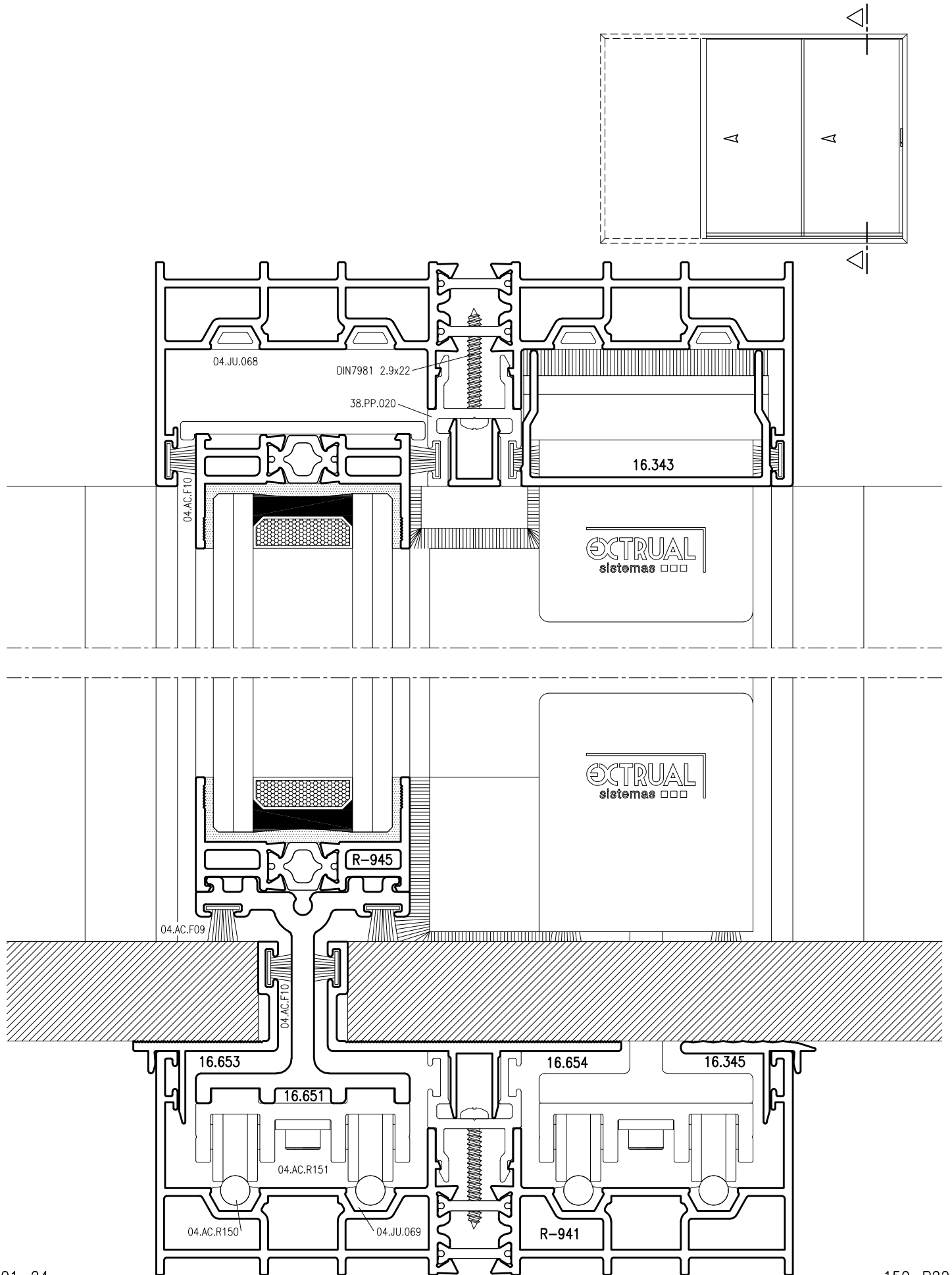

SECCION HORIZONTAL 2 HOJAS ENTREMUROS

Los perfiles 13.248+7.438 se pueden sustituir por un rectangular o ángulo donde enrasar la obra y dejar la hoja totalmente oculta.

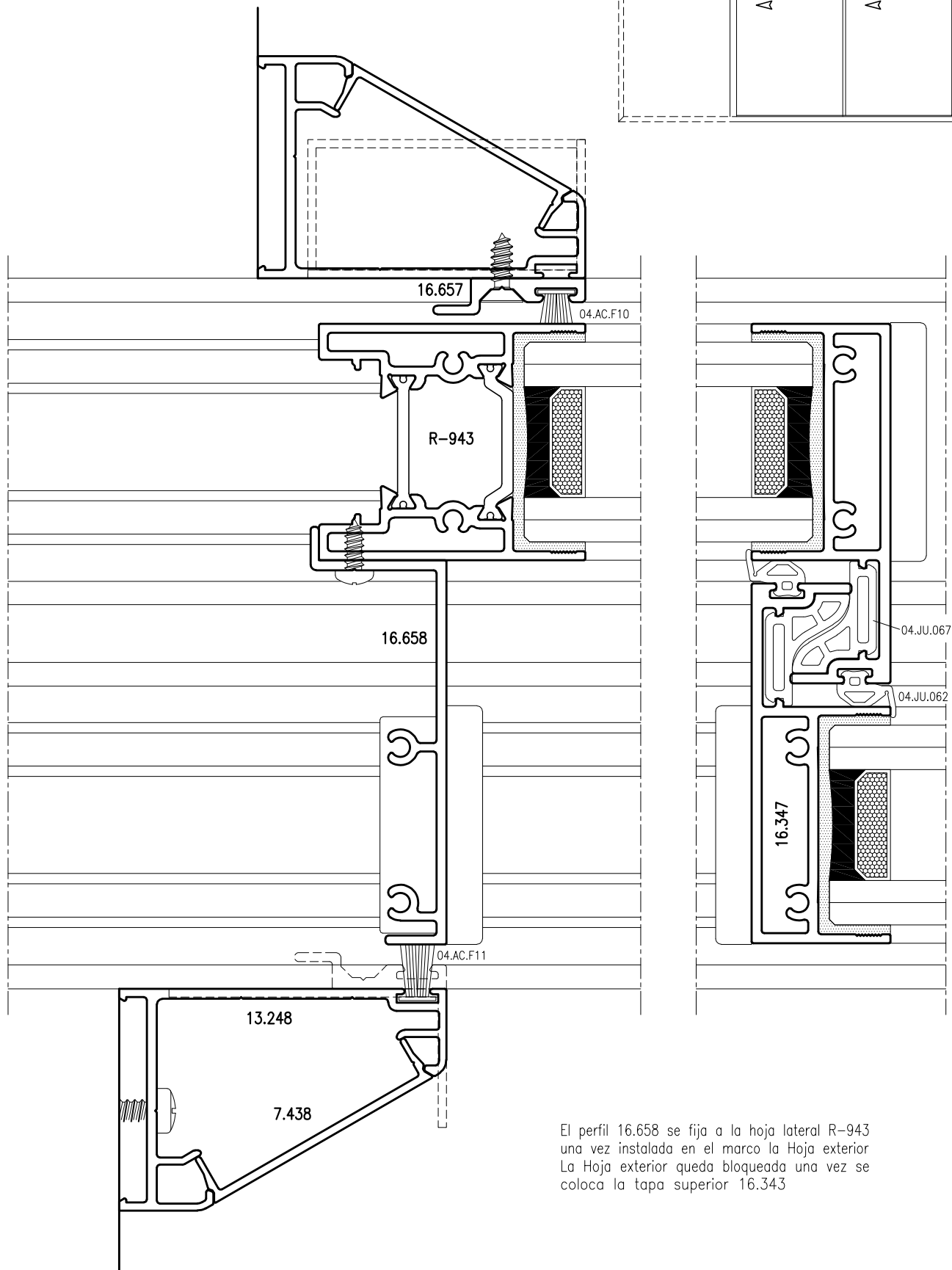
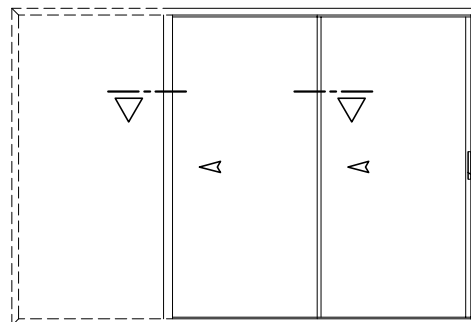

El perfil 16.658 se fija a la hoja lateral R-943 una vez instalada en el marco la Hoja exterior La Hoja exterior queda bloqueada una vez se coloca la tapa superior 16.343

SECCION HORIZONTAL 3 HOJAS ENTREMUROS

Los perfiles 13.248+7.438 en el exterior se pueden sustituir por un rectangular o ángulo donde enrasar la obra y dejar la hoja totalmente oculta.

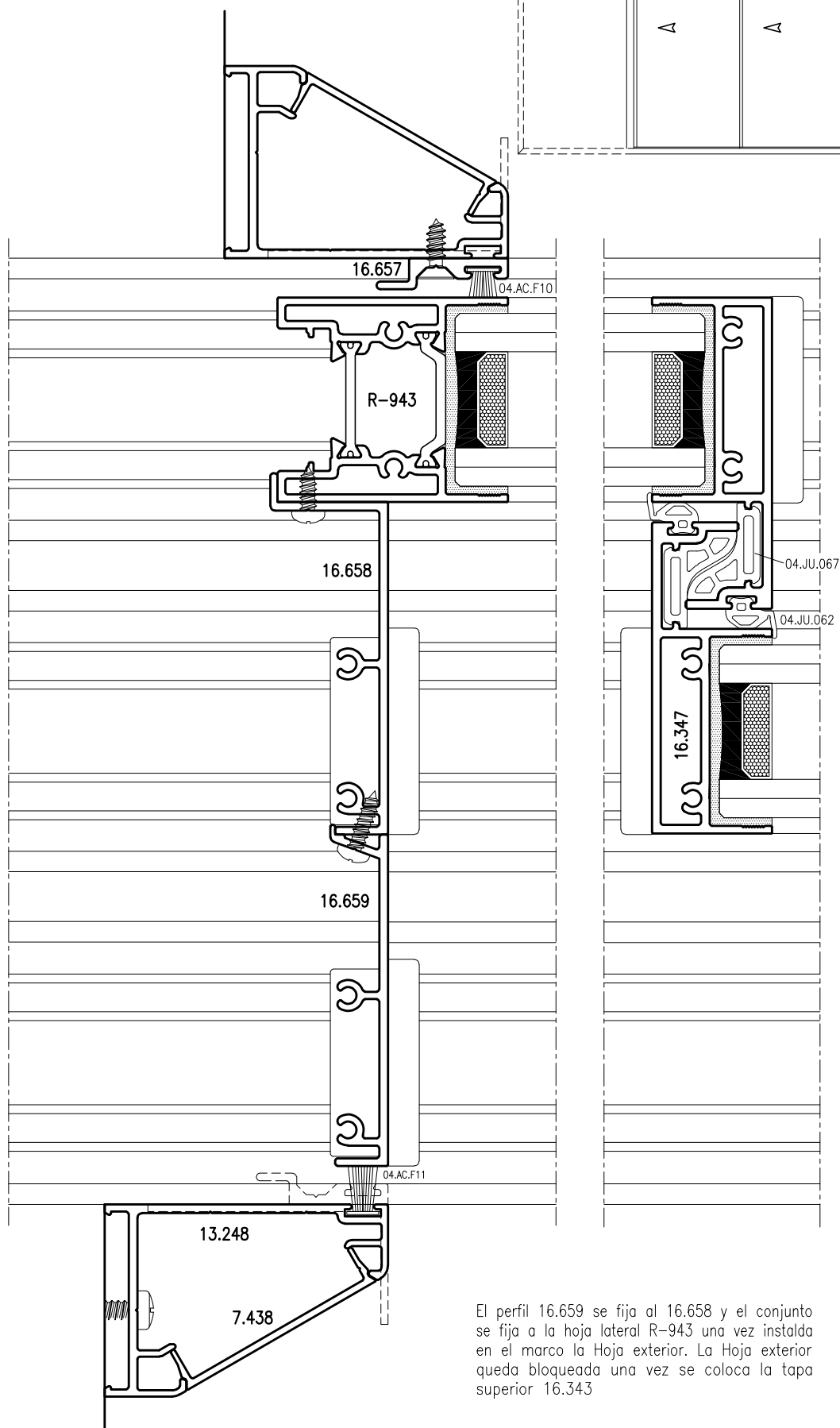
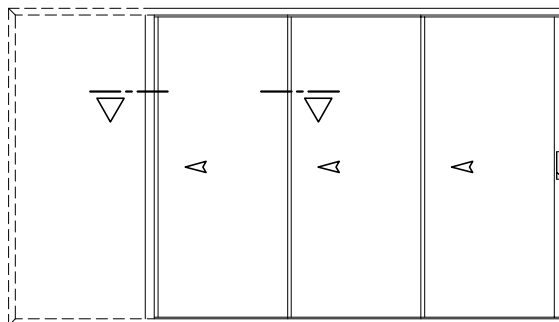

El perfil 16.659 se fija al 16.658 y el conjunto se fija a la hoja lateral R-943 una vez instalada en el marco la Hoja exterior. La Hoja exterior queda bloqueada una vez se coloca la tapa superior 16.343

SECCION HORIZONTAL 4 HOJAS ENTREMUROS

El perfil 16.659 se fija al 16.658 y el conjunto se fija a la hoja lateral R-943 una vez instalada en el marco la Hoja exterior queda bloqueada una vez se coloca la tapa superior 16.657

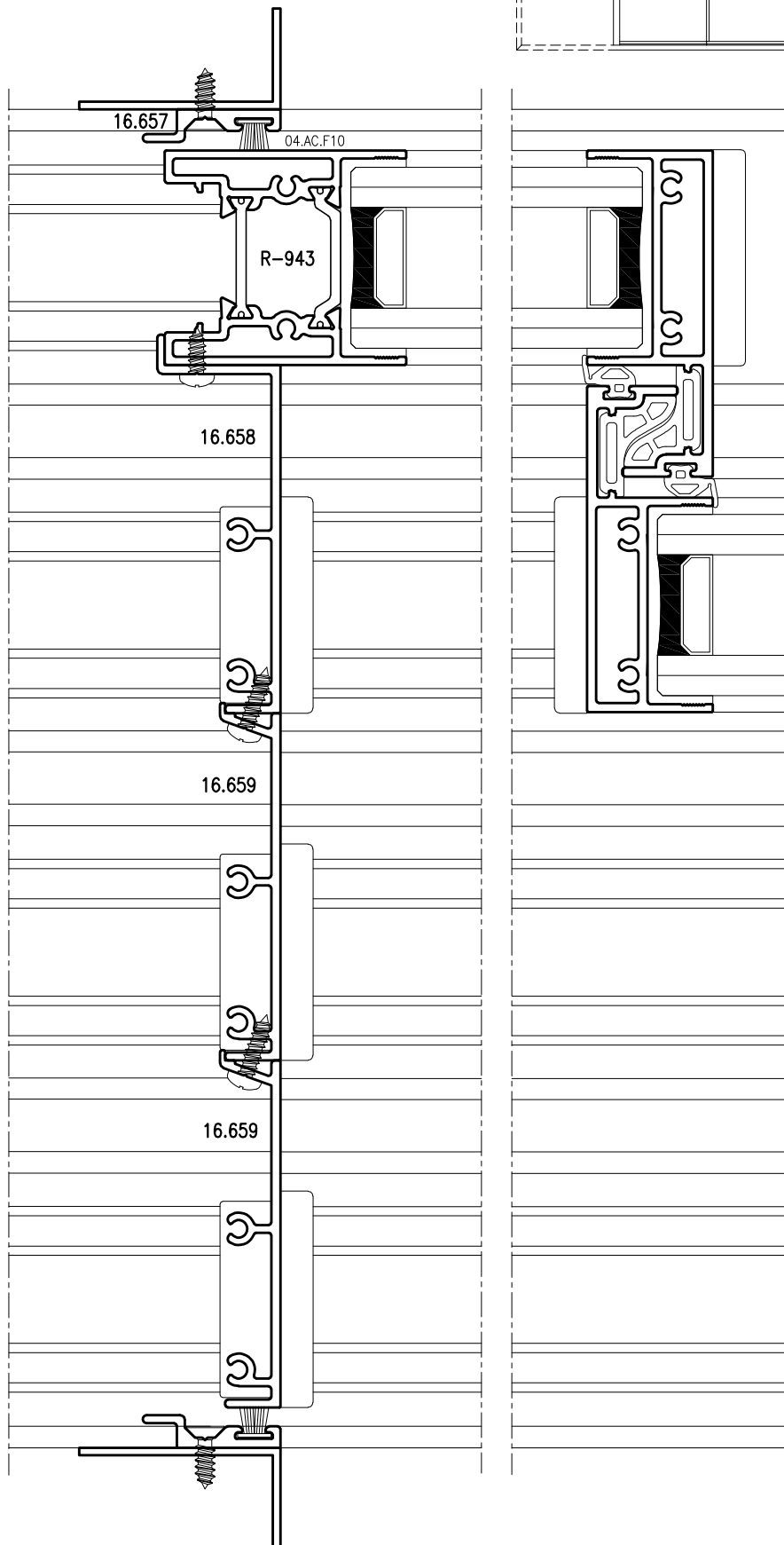
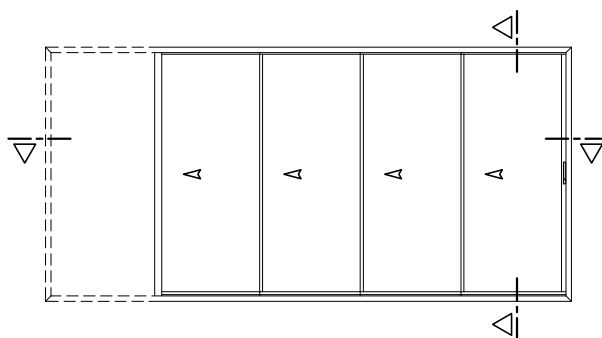

SECCION HORIZONTAL ESQUINA SALIENTE 2 HOJAS

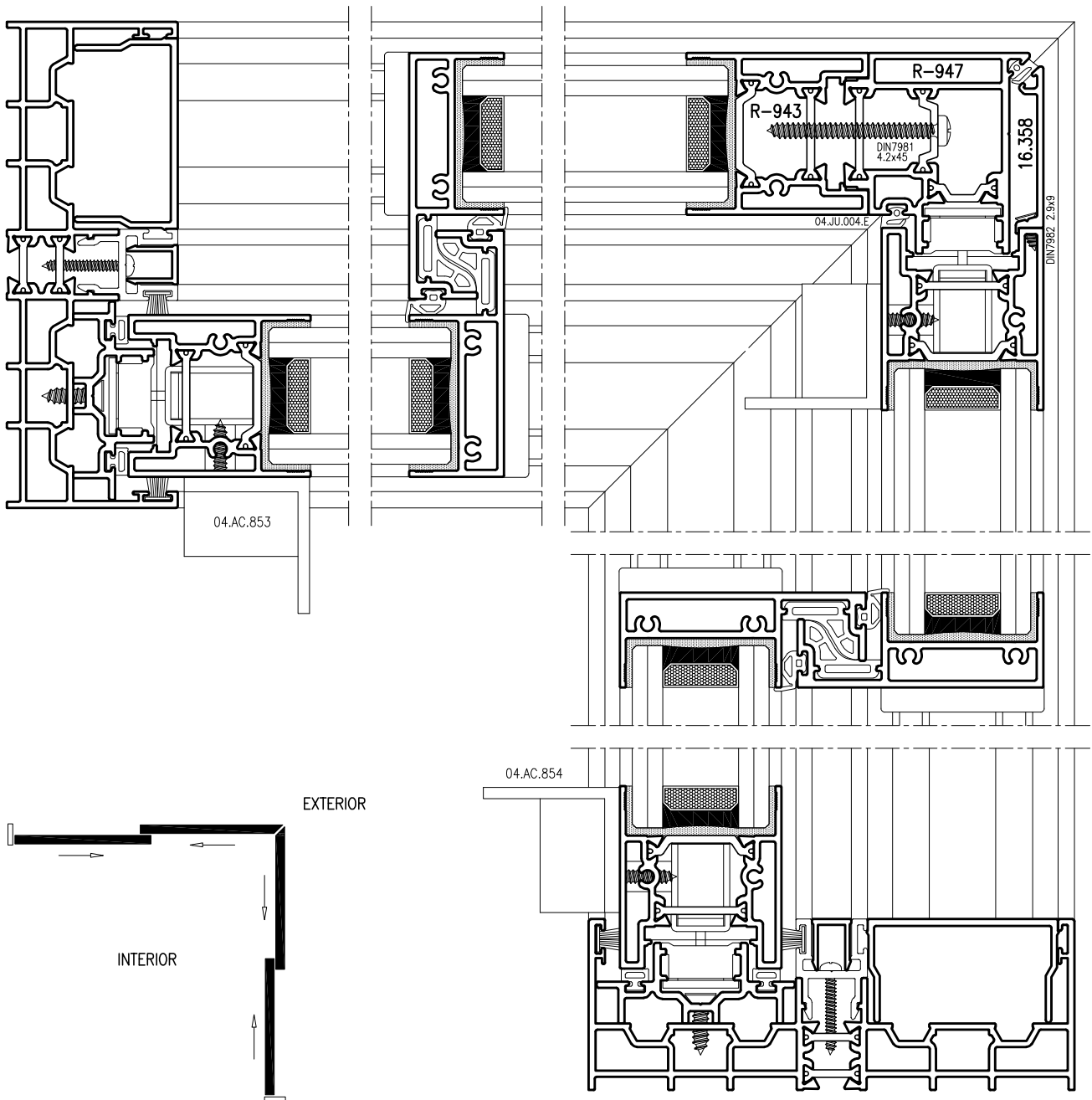
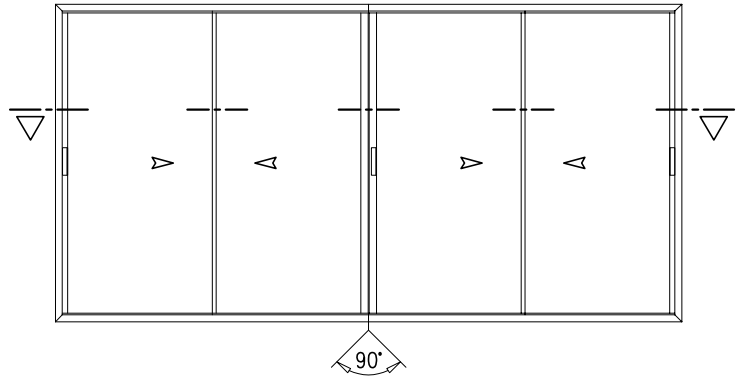

SECCION HORIZONTAL ESQUINA ENTRANTE 2 HOJAS

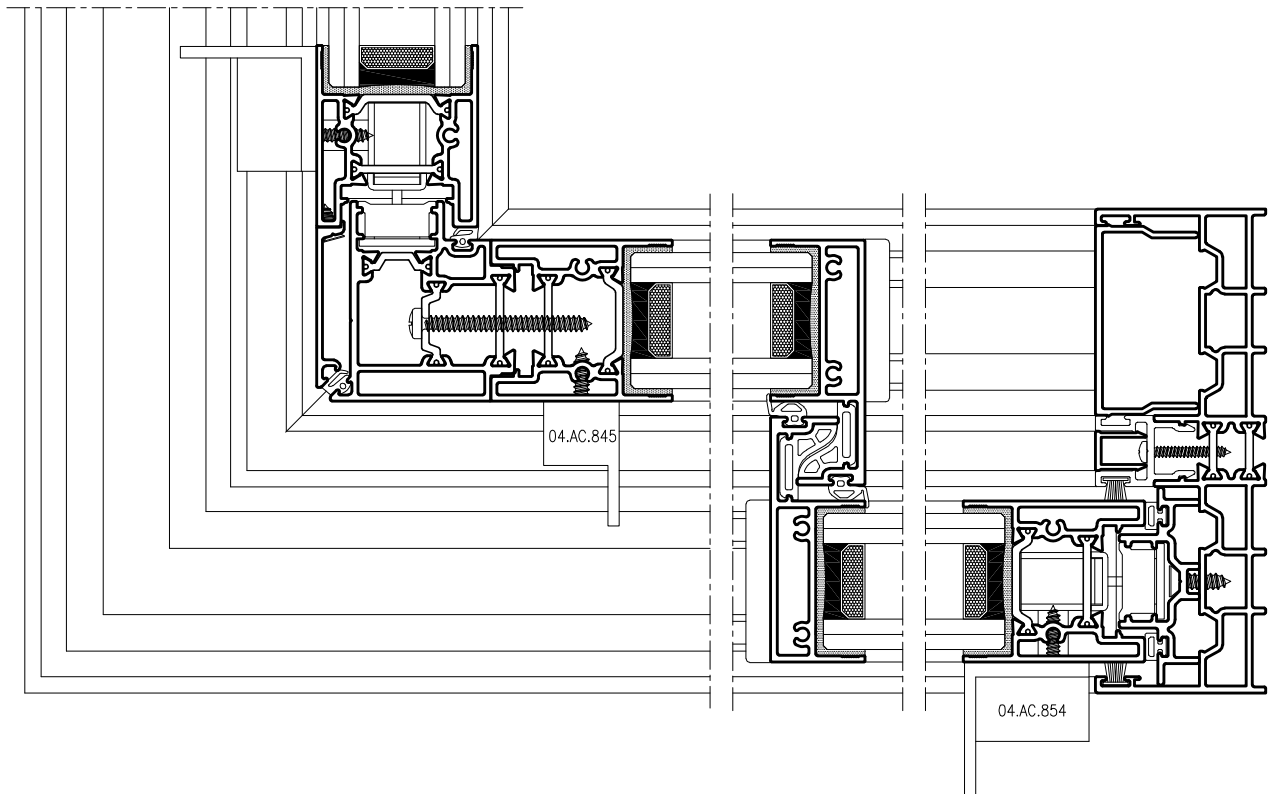
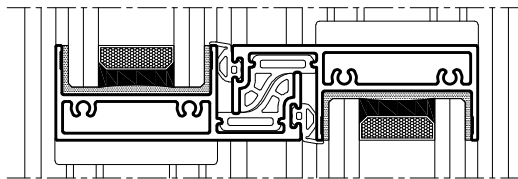
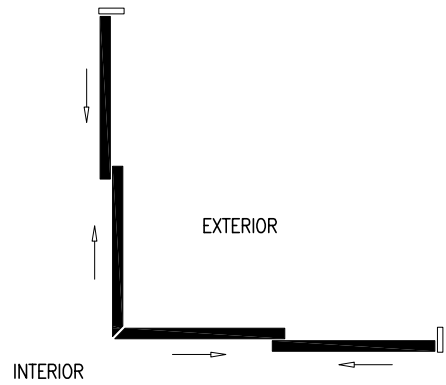
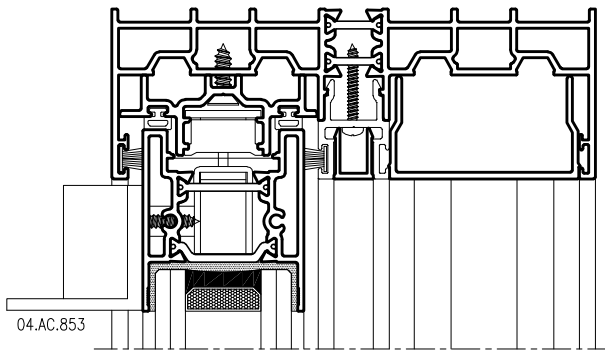
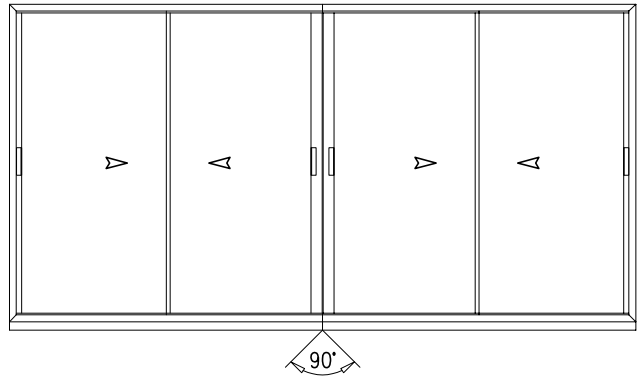

SECCION VERTICAL 2 HOJAS

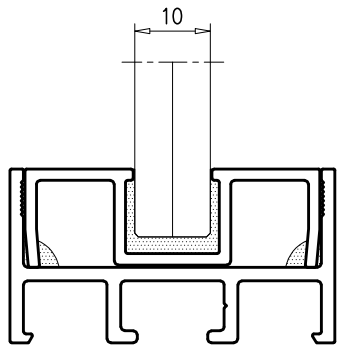

Para Vidrios Monolíticos descontar a las medidas de vidrio de Catálogo 4mm tanto en vertical como en horizontal.

Utilizar calzos de apoyo de vidrio de 2mm.

Utilizar Siliona DOWSIL 776 InstantFix para el pegado del vidrio así como para el pegado del reductor 17.421 a las Hojas.

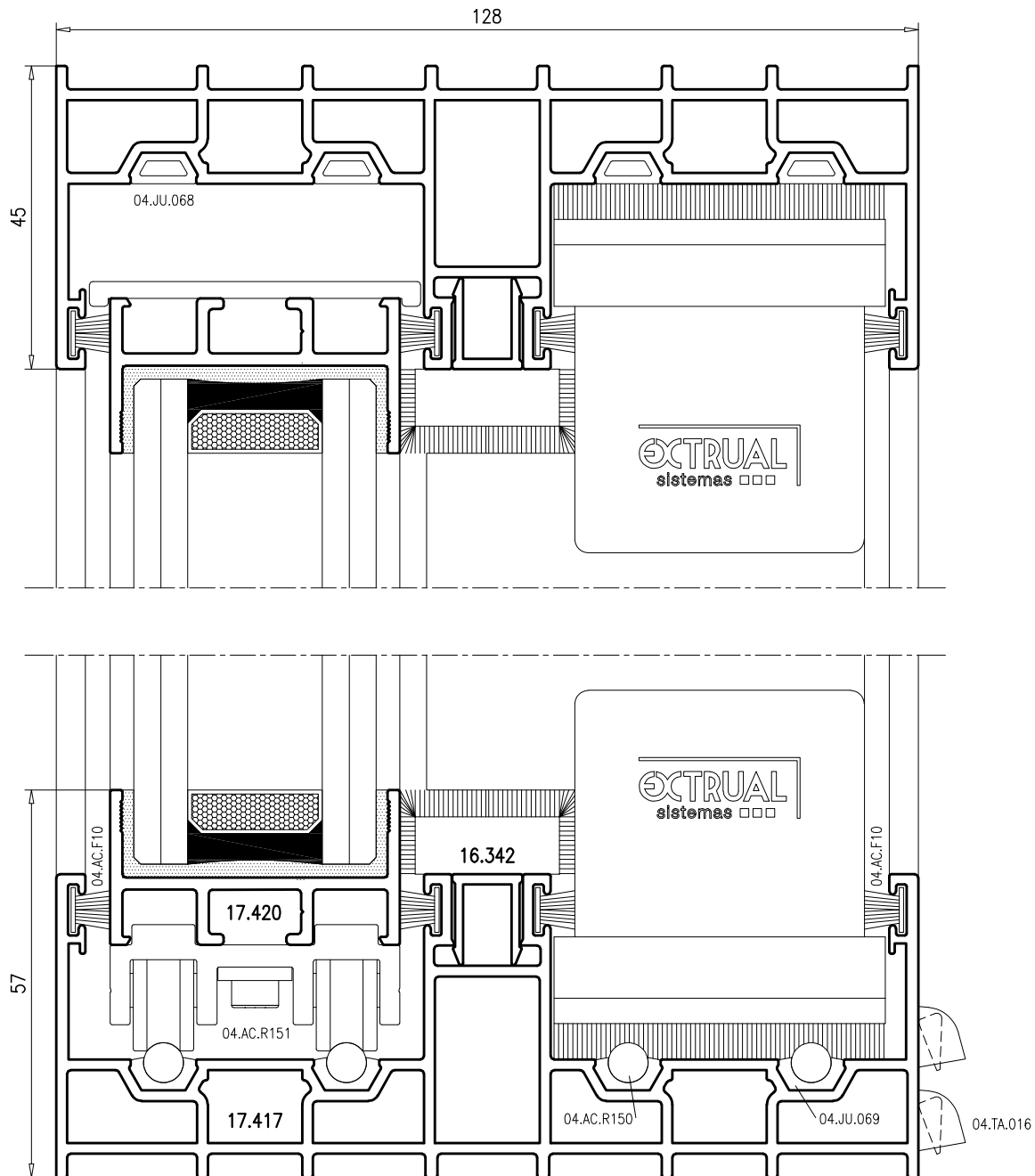
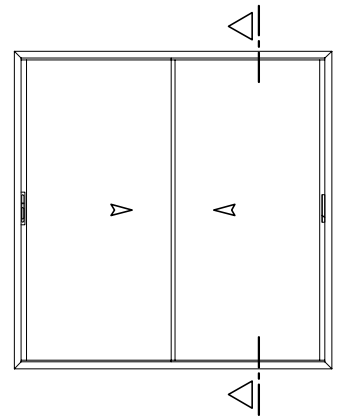

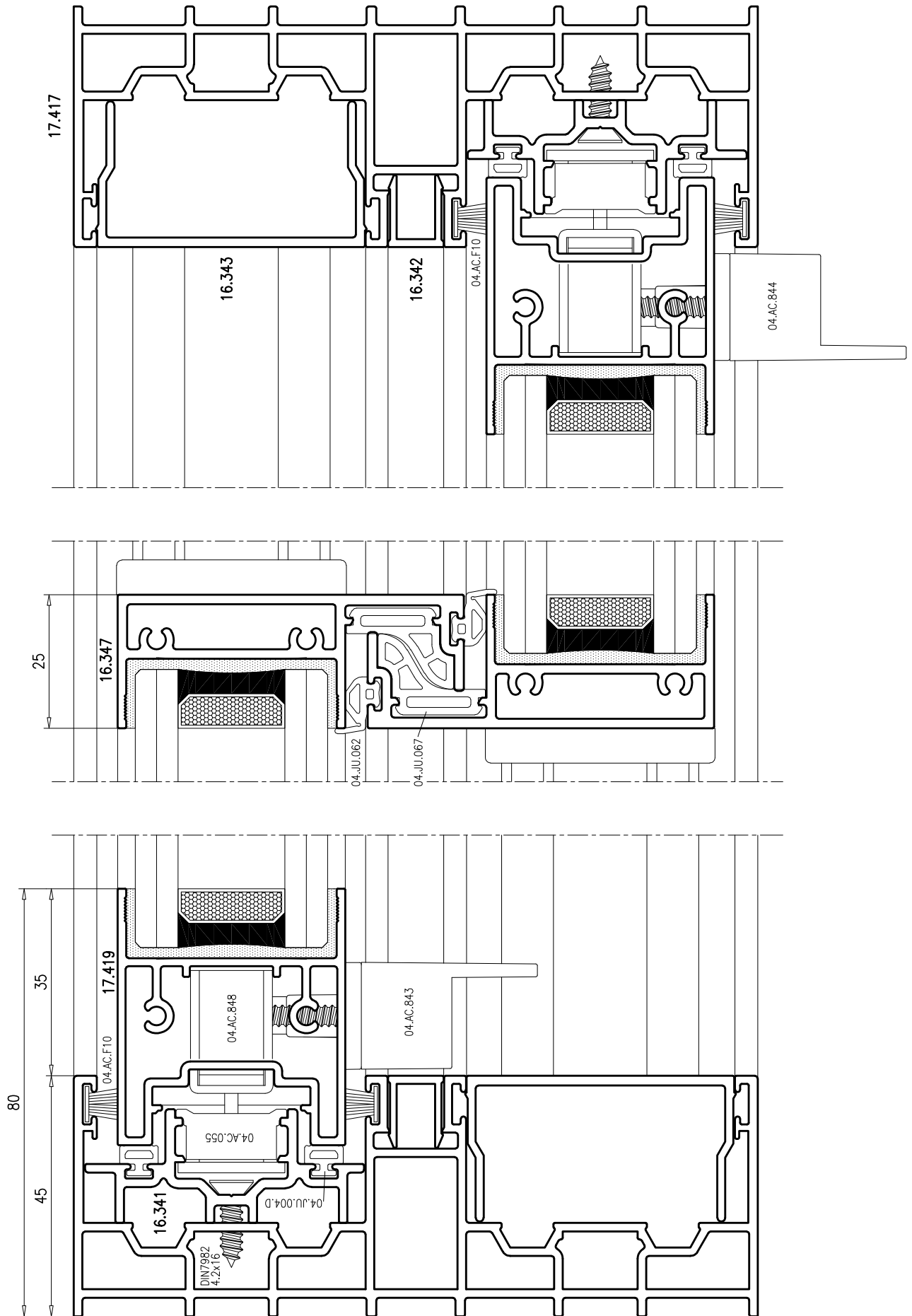

SECCION HORIZONTAL 2 HOJAS

BALCONERA 1 HOJA + FIJO

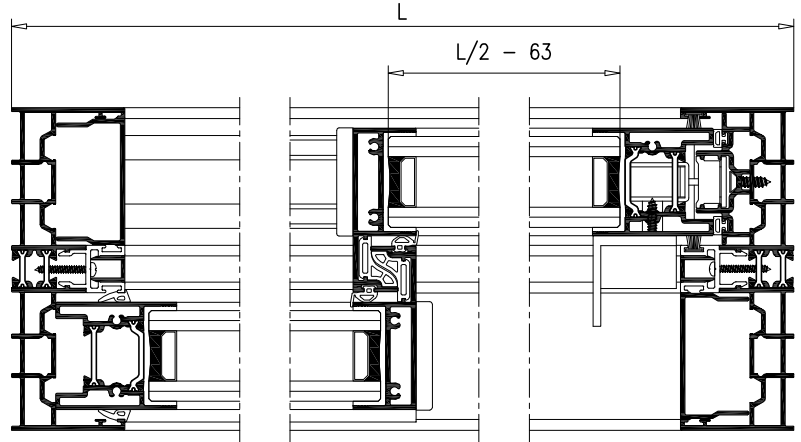
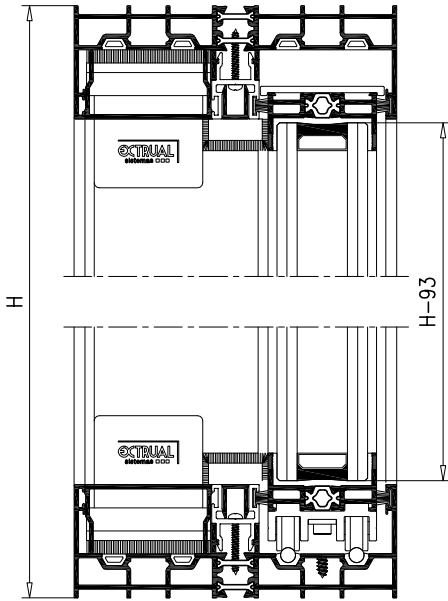

BALCONERA 1 HOJA + FIJO
Marco Inferior Oculto Tapas de Aluminio

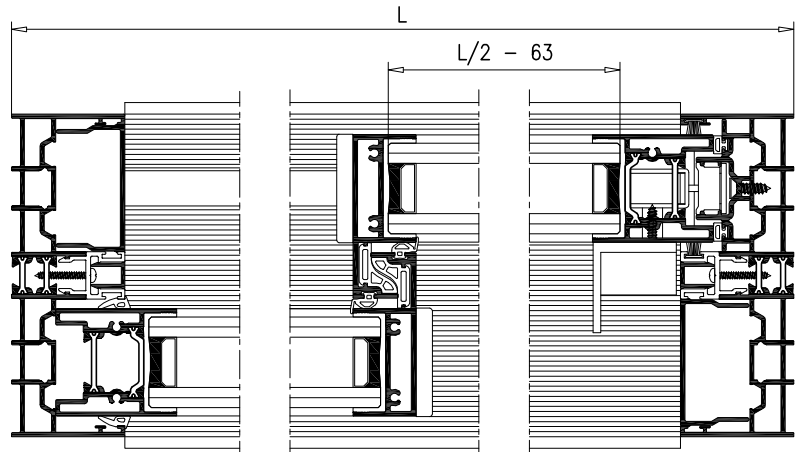
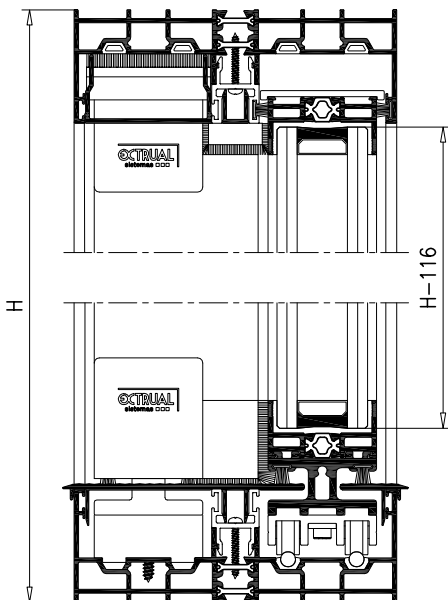



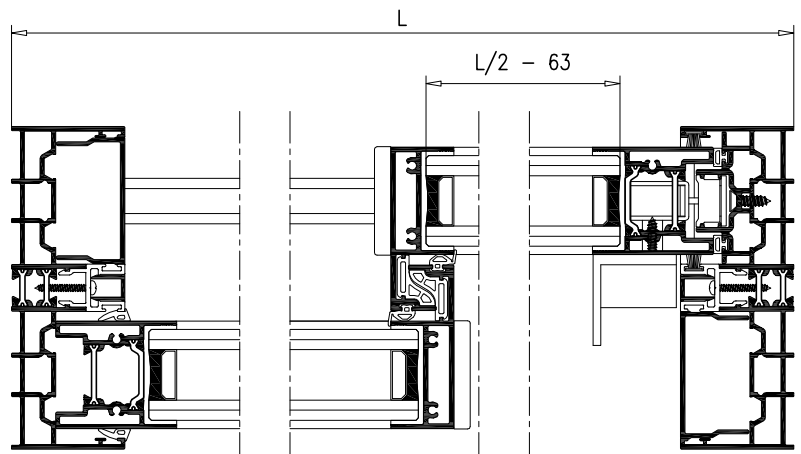
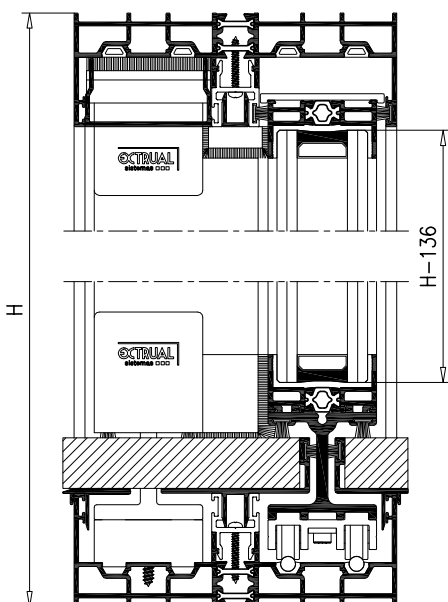





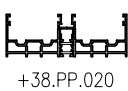





































































BALCONERA 1 HOJA + FIJO
Marco Inferior Oculto Piso Corrido



BALCONERA 1 HOJA + FIJO

PERFILES

REFERENCIA	DENOMINACION	MARCO INFERIOR VISTO		MARCO INFERIOR OCULTO TAPAS ALUMINIO		MARCO INFERIOR OCULTO PISO CORRIDO	
		CANT.	CORTE	CANT.	CORTE	CANT.	CORTE
R-941	MARCO  +38.PP.020	2		2		2	
		2		2		2	
R-943	HOJA LATERAL 	2		2		2	
R-945	HOJA SUP/INF 	4		4		4	
16.349	SUPLEMENT. HOJA 			2			
16.651	SUPLEMENT. HOJA 					4	
16.347	HOJA DE CIERRE 	2		2		2	
16.341	CIERRE LATERAL 	1		1		1	
16.342	TAPA CANAL 	2		1		1	
		2		1		1	
		2		2		2	
16.343	TAPA MARCO 	2		1		1	
		2		2		2	
16.344*	TAPA CENTRAL 			1			
16.345*	TAPA LATERAL 			1		1	
				1			
16.346*	TAPA DOBLE 			1			
16.652*	TAPA CENTRAL 					1	
16.653*	TAPA LATERAL 					1	
						1	
16.654*	TAPA MULTIPLE 					1	
R-948	SOLERA 	1		1		1	
15.686	TAPA CANALETA 	1		1			
16.351	CANALETA DRENAJE 	1		1		1	
16.348	REFUERZO TIRADOR 	2		2		2	
10.466	TAPETA TIRADOR 	2		2		2	

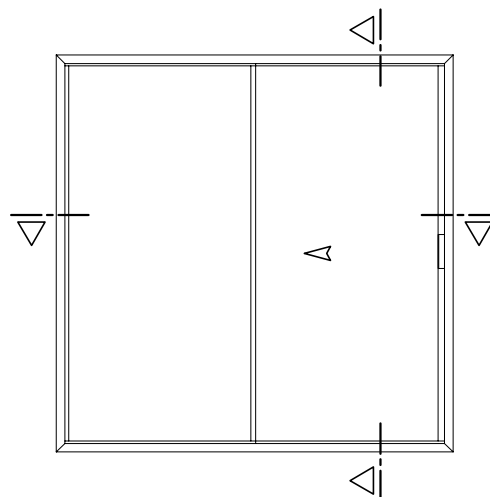

En caso de piso corrido las tapas que ocultan el marco inferior deben de ser registrables para permitir sacar las hojas en caso de necesidad.

ACCESORIOS

REFERENCIA	DENOMINACION	M.INF. VISTO	M.INF. OCULTO TAPAS ALUMINIO	M.INF. OCULTO PISO CORRIDO
		UNIDADES	UNIDADES	UNIDADES
04.AC.848	Cremona 3 puntos	1	1	1
04.AC.055.M	Cerradero	3	3	3
04.AC.056	Embellecedor Cerradero	3	3	3
04.AC.854	Manilla Izda.	1	1	1
04.AC.067	Kit Hoja Lateral	2	2	2
04.AC.068	Kit Hoja Central	2		
04.AC.069	Kit H.Central M.Inf. Oculto Tapas Aluminio		2	
04.AC.078	Kit H.Central M.Inf. Oculto Piso Corrido			2
04.AC.070	Tapa H.Lateral M.Inf. Oculto Tapas Aluminio		2	
04.AC.079	Tapa H.Lateral M.Inf. Oculto Piso Corrido			2
04.AC.071	Kit Cortavientos	1		
04.AC.080	Kit Cortavientos Marco Inferior Oculto		1	1
04.AC.075	Taco Estanq. M.Inf. Oculto Tapas Aluminio		1	
04.AC.081	Taco Estanq. M.Inf. Oculto Piso Corrido			1
04.ES.083	Escuadra Marco	8	8	8
04.AC.F10	Felpudo Marco	2L+2H	L+2H	3L+2H
04.AC.F09	Felpudo Suplementos Hoja 16.349 y 16.651		2L	2L
04.JU.004.D	Junta Cierre Lateral	2H	2H	2H
04.JU.062	Junta Cruce Central	2H	2H	2H
04.JU.067	Junta Cruce Central	2H	2H	2H
04.JU.068	Junta Tapa canal Marco	4L	4L	4L
04.JU.069	Junta Carril	x2	L-200	L-200
04.AC.R150	Carril Acero Inox.	x2	L-200	L-200
04.AC.R151	Rodamiento	2	2	2
04.AC.R153	Kit Angulo Rod. M.Inf. Oculto Tapas Aluminio		1	
04.AC.R154	Kit Angulo Rod. M.Inf. Oculto Piso Corrido			1
04.AC.074	Calzo Hoja Fija	2	2	2
04.JA.004	Junta Hoja Fija	2L+2H	L+2H	L+2H
04.TA.069	Juego Tapas Tirador	2	2	2
04.TA.070	Tapa para Canaleta	2	2	2
04.TA.071	Tapa para Solera	2	2	2
04.AC.073	Calzo Vidrio	Según dimensiones de Vidrio		

*Se indica la longitud total necesaria. Las tapas se colocan en tramos para permitir el montaje.

El perfil 16.651 se coloca deslizado en la hoja inferior en 2 trozos, para permitir sacar la hoja del marco en caso de necesidad una vez colocado el piso.

BALCONERA 2 HOJAS

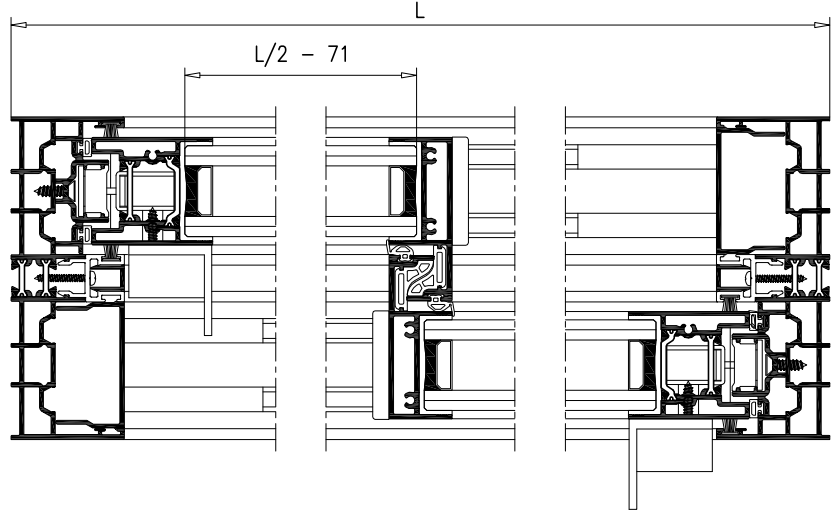
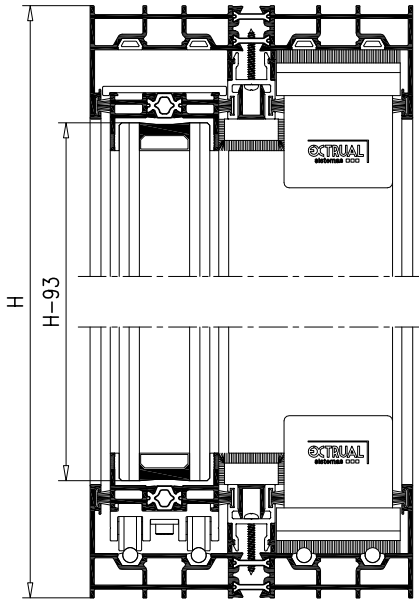

BALCONERA 2 HOJAS

Marco Inferior Oculto Tapas de Aluminio

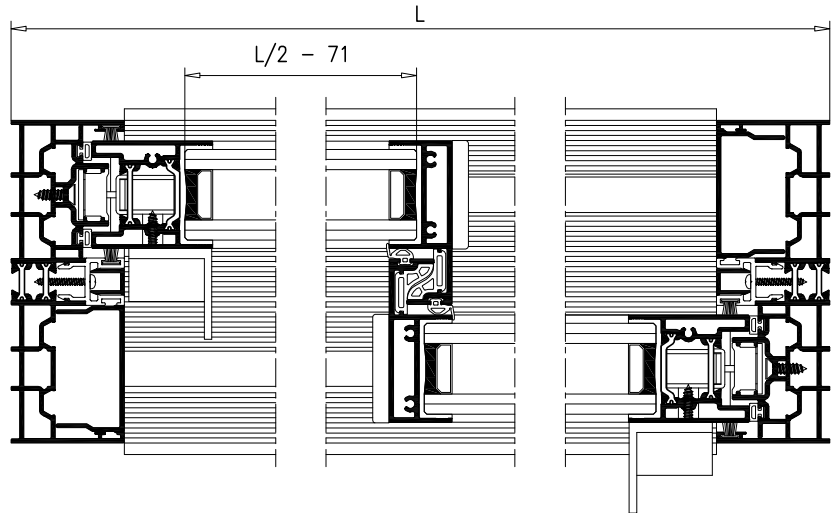
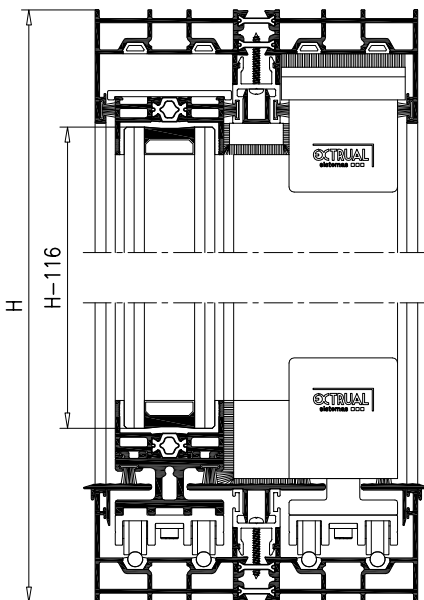

BALCONERA 2 HOJAS

Marco Inferior Oculto Piso Corrido

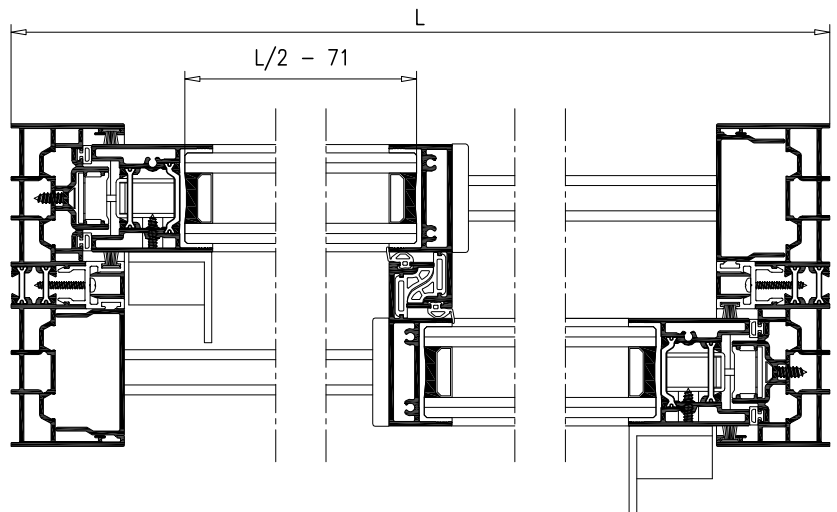
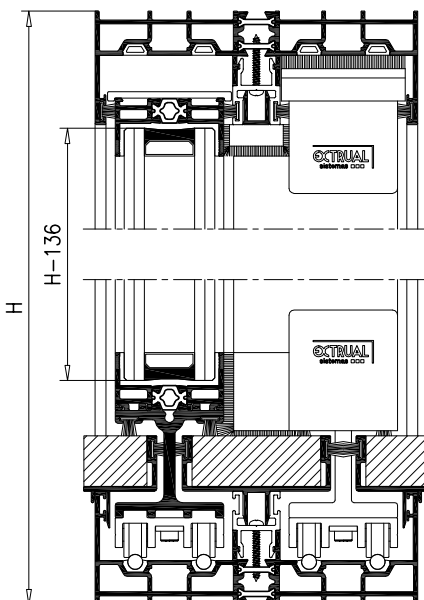

BALCONERA 2 HOJAS

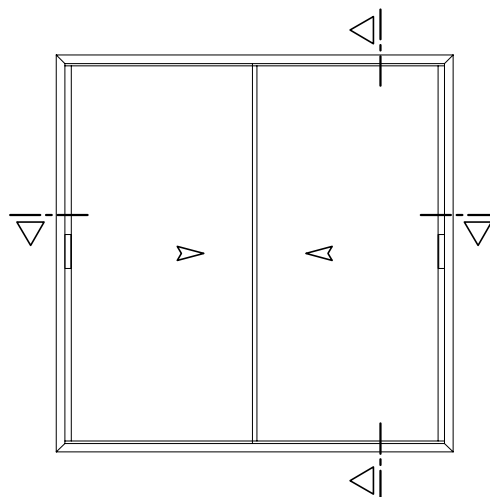

PERFILES

REFERENCIA	DENOMINACION	MARCO INFERIOR VISTO		MARCO INFERIOR OCULTO TAPAS ALUMINIO		MARCO INFERIOR OCULTO PISO CORRIDO	
		CANT.	CORTE	CANT.	CORTE	CANT.	CORTE
R-941	MARCO +38.PP.020	2	L H	2	L H	2	L H
R-943	HOJA LATERAL	2	H-115	2	H-138	2	H-158
R-945	HOJA SUP/INF	4	(L/2)-31	4	(L/2)-31	4	(L/2)-31
16.349	SUPLEMENT. HOJA			2	(L/2)-31		
16.651	SUPLEMENT. HOJA					4	(L/4)-15.5
16.347	HOJA DE CIERRE	2	H-115	2	H-138	2	H-158
16.341	CIERRE LATERAL	2	H-37	2	H-74	2	H-94
16.342	TAPA CANAL	4	(L/2)-58 H-72	2	(L/2)-58 H-72	2	(L/2)-58 H-72
16.343	TAPA MARCO	2	H-36	2	H-36	2	H-36
16.344*	TAPA CENTRAL			1	L-90		
16.345*	TAPA LATERAL			2	L-90		
16.652*	TAPA CENTRAL					1	L-90
16.653*	TAPA LATERAL					2	L-90
R-948	SOLERA	1	L-4	1	L-4	1	L-4
15.686	TAPA CANALETA	1	L-94	1	L-94		
16.351	CANALETA DRENAJE	1	L-94	1	L-94	1	L-94
16.348	REFUERZO TIRADOR	2	H-119	2	H-142	2	H-162
10.466	TAPETA TIRADOR	2	H-119	2	H-142	2	H-162

ACCESORIOS

REFERENCIA	DENOMINACION	M.INF. VISTO	M.INF. OCULTO TAPAS ALUMINIO	M.INF. OCULTO PISO CORRIDO
		UNIDADES	UNIDADES	UNIDADES
04.AC.848	Cremona 3 puntos	2	2	2
04.AC.055.M	Cerradero	6	6	6
04.AC.056	Embellecedor Cerradero	6	6	6
04.AC.853	Manilla Dcha.	1	1	1
04.AC.854	Manilla Izda.	1	1	1
04.AC.067	Kit Hoja Lateral	2	2	2
04.AC.068	Kit Hoja Central	2		
04.AC.069	Kit H.Central M.Inf. Oculto Tapas Aluminio		2	
04.AC.078	Kit H.Central M.Inf. Oculto Piso Corrido			2
04.AC.070	Tapa H.Lateral M.Inf. Oculto Tapas Aluminio		2	
04.AC.079	Tapa H.Lateral M.Inf. Oculto Piso Corrido			2
04.AC.071	Kit Cortavientos	1		
04.AC.080	Kit Cortavientos Marco Inferior Oculto		1	1
04.AC.075	Taco Estanq. M.Inf. Oculto Tapas Aluminio		2	
04.AC.081	Taco Estanq. M.Inf. Oculto Piso Corrido			2
04.ES.083	Escuadra Marco	8	8	8
04.AC.F10	Felpudo Marco	4L+4H	2L+4H	6L+4H
04.AC.F09	Felpudo Suplementos Hoja 16.349 y 16.651		2L	2L
04.JU.004.D	Junta Cierre Lateral	4H	4H	4H
04.JU.062	Junta Cruce Central	2H	2H	2H
04.JU.067	Junta Cruce Central	2H	2H	2H
04.JU.068	Junta Tapa Canal Marco	4L	4L	4L
04.JU.069	Junta Carril	x4	L-200	L-200
04.AC.R150	Carril Acero Inox.	x4	L-200	L-200
04.AC.R151	Rodamiento	4	4	4
04.AC.R153	Kit Angulo Rod. M.Inf. Oculto Tapas Aluminio		2	
04.AC.R154	Kit Angulo Rod. M.Inf. Oculto Piso Corrido			2
04.TA.069	Juego Tapas Tirador	2	2	2
04.TA.070	Tapa para Canaleta	2	2	2
04.TA.071	Tapa para Solera	2	2	2
04.AC.073	Calzo Vidrio	Según dimensiones de Vidrio		

*Se indica la longitud total necesaria. Las tapas se colocan en tramos para permitir el montaje.

El perfil 16.651 se coloca deslizado en la hoja inferior en 2 trozos, para permitir sacar la hoja del marco en caso de necesidad una vez colocado el piso.

BALCONERA 2 HOJAS Con Llave

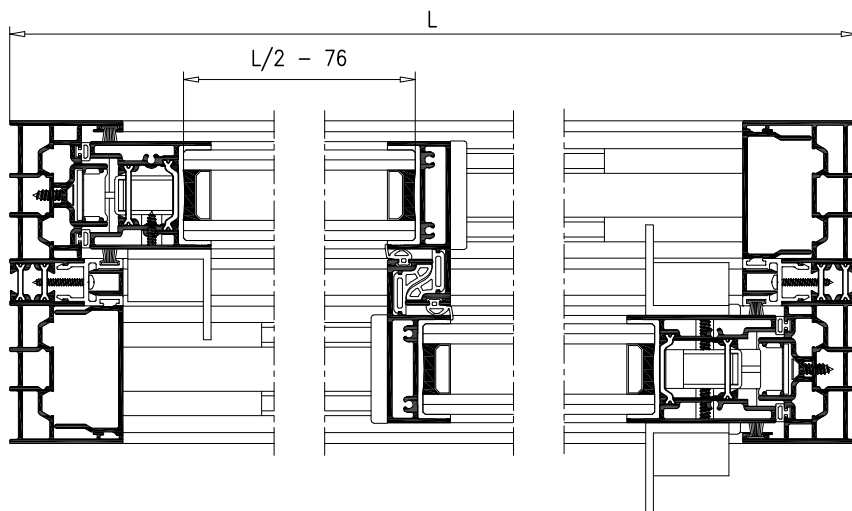
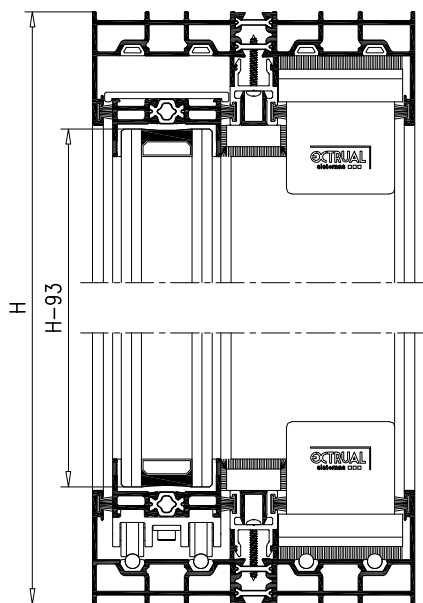

**BALCONERA 2 HOJAS Con Llave
Marco Inferior Oculto Tapas de Aluminio**

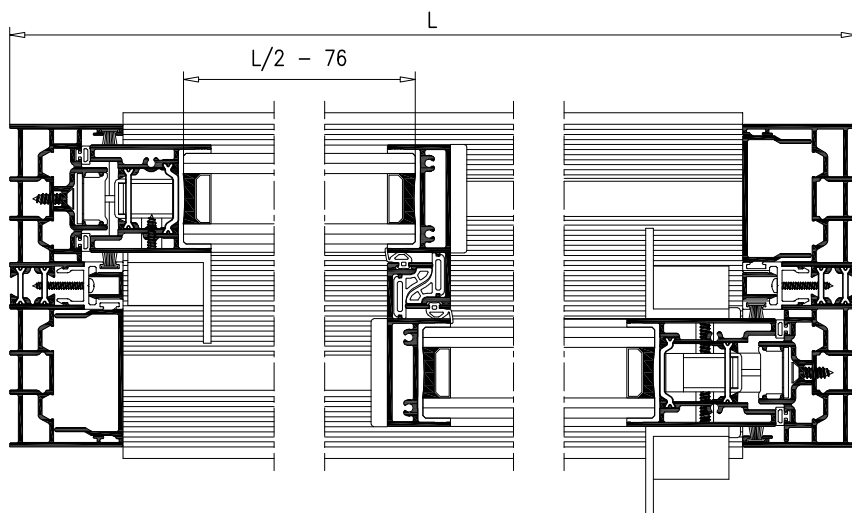
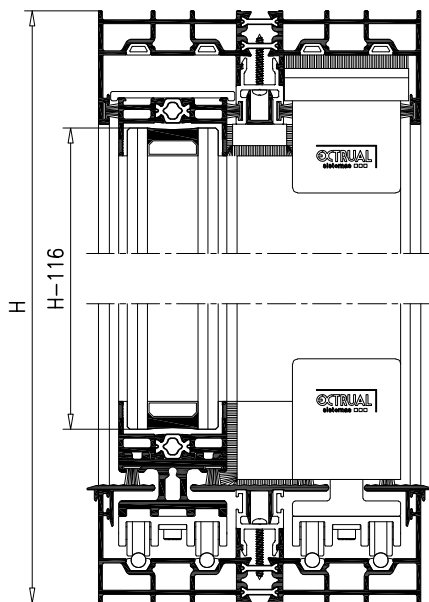



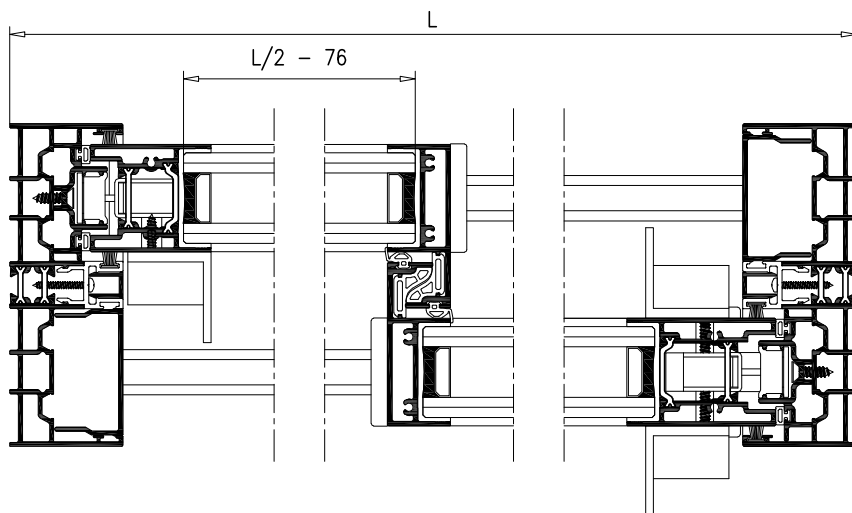
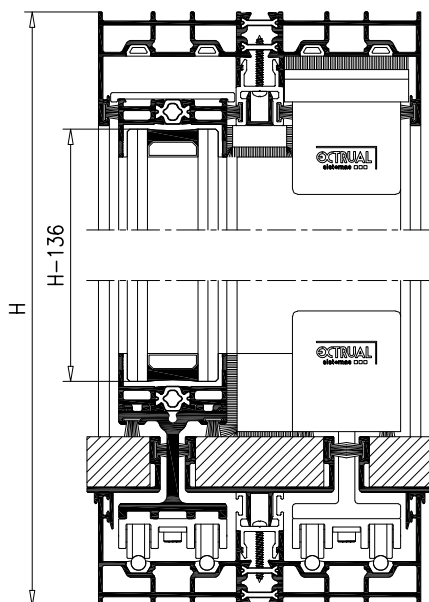



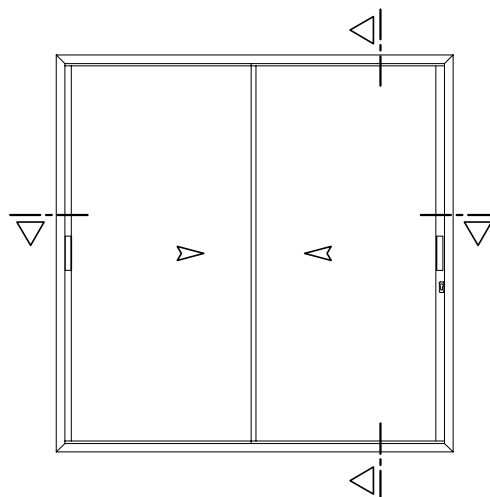











**BALCONERA 2 HOJAS Con Llave
Marco Inferior Oculto Piso Corrido**



BALCONERA 2 HOJAS con Llave

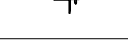

PERFILES

REFERENCIA	DENOMINACION	MARCO INFERIOR VISTO		MARCO INFERIOR OCULTO TAPAS ALUMINIO		MARCO INFERIOR OCULTO PISO CORRIDO		
		CANT.	CORTE	CANT.	CORTE	CANT.	CORTE	
R-941	 +38.PP.020	MARCO	2 2	L H	2 2	L H	2 2	L H
R-943		HOJA LATERAL	1	H-115	1	H-138	1	H-158
R-944		HOJA LATERAL	1	H-115	1	H-138	1	H-158
R-945		HOJA SUP/INF	2 2	(L/2)-36 (L/2)-25	2 2	(L/2)-36 (L/2)-25	2 2	(L/2)-36 (L/2)-25
16.349		SUPLEMENT. HOJA			1 1	(L/2)-36 (L/2)-25		
16.651		SUPLEMENT. HOJA					2 2	(L/4)-18 (L/4)-12.5
16.347		HOJA DE CIERRE	2	H-115	2	H-138	2	H-158
16.341		CIERRE LATERAL	2	H-37	2	H-74	2	H-94
16.342		TAPA CANAL	2 2 2	(L/2)-52 (L/2)-63 H-72	1 1 2	(L/2)-52 (L/2)-63 H-72	1 1 2	(L/2)-52 (L/2)-63 H-72
16.343		TAPA MARCO	2	H-36	2	H-36	2	H-36
16.344*		TAPA CENTRAL			1	L-90		
16.345*		TAPA LATERAL			2	L-90		
16.652*		TAPA CENTRAL					1	L-90
16.653*		TAPA LATERAL					2	L-90
R-948		SOLERA	1	L-4	1	L-4	1	L-4
15.686		TAPA CANALETA	1	L-94	1	L-94		
16.351		CANALETA DRENAJE	1	L-94	1	L-94	1	L-94
16.348		REFUERZO TIRADOR	2	H-119	2	H-142	2	H-162
10.466		TAPETA TIRADOR	2	H-119	2	H-142	2	H-162

ACCESORIOS

REFERENCIA	DENOMINACION	M.INF. VISTO	M.INF. OCULTO TAPAS ALUMINIO	M.INF. OCULTO PISO CORRIDO
		UNIDADES	UNIDADES	UNIDADES
04.AC.848	Cremona 3 puntos	1	1	1
04.AC.850	Cremona 3 puntos con llave	1	1	1
04.AC.055.M	Cerradero	6	6	6
04.AC.056	Embellecedor Cerradero	6	6	6
04.AC.853	Manilla Dcha.	1	1	1
04.AC.856	Manilla Doble	1	1	1
04.CT.150	Cilindro Doble	1	1	1
04.CEP.150	Escudo para cilindro	1	1	1
04.AC.067	Kit Hoja Lateral	2	2	2
04.AC.068	Kit Hoja Central	2		
04.AC.069	Kit H.Central M.Inf. Oculto Tapas Aluminio		2	
04.AC.078	Kit H.Central M.Inf. Oculto Piso Corrido			2
04.AC.070	Tapa H.Lateral M.Inf. Oculto Tapas Aluminio		2	
04.AC.079	Tapa H.Lateral M.Inf. Oculto Piso Corrido			2
04.AC.071	Kit Cortavientos	1		
04.AC.080	Kit Cortavientos Marco Inferior Oculto		1	1
04.AC.075	Taco Estanq. M.Inf. Oculto Tapas Aluminio		2	
04.AC.081	Taco Estanq. M.Inf. Oculto Piso Corrido			2
04.ES.083	Escuadra Marco	8	8	8
04.AC.F10	Felpudo Marco	4L+4H	2L+4H	6L+4H
04.AC.F09	Felpudo Suplementos Hoja 16.349 y 16.651		2L	2L
04.JU.004.D	Junta Cierre Lateral	4H	4H	4H
04.JU.062	Junta Cruce Central	2H	2H	2H
04.JU.067	Junta Cruce Central	2H	2H	2H
04.JU.068	Junta Tapa canal Marco	4L	4L	4L
04.JU.069	Junta Carril	x4	L-200	L-200
04.AC.R150	Carril Acero Inox.	x4	L-200	L-200
04.AC.R151	Rodamiento	4	4	4
04.AC.R153	Kit Angulo Rod. M.Inf. Oculto Tapas Aluminio		2	
04.AC.R154	Kit Angulo Rod. M.Inf. Oculto Piso Corrido			2
04.TA.069	Juego Tapas Tirador	2	2	2
04.TA.070	Tapa para Canaleta	2	2	2
04.TA.071	Tapa para Solera	2	2	2
04.AC.073	Calzo Vidrio	Según dimensiones de Vidrio		

*Se indica la longitud total necesaria. Las tapas se colocan en tramos para permitir el montaje.

El perfil 16.651 se coloca deslizado en la hoja inferior en 2 trozos, para permitir sacar la hoja del marco en caso de necesidad una vez colocado el piso.

BALCONERA 2 HOJAS + FIJO CENTRAL

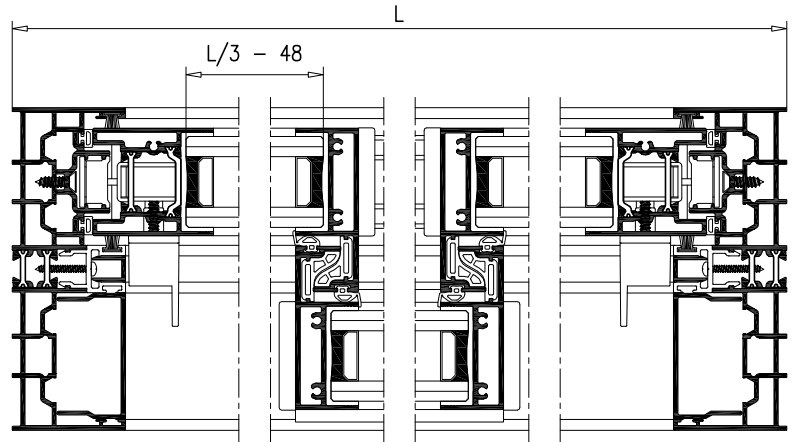
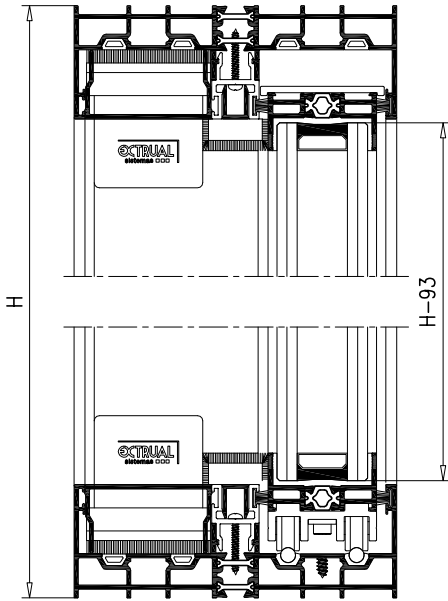

BALCONERA 2 HOJAS + FIJO CENTRAL
Marco Inferior Oculto Tapas de Aluminio

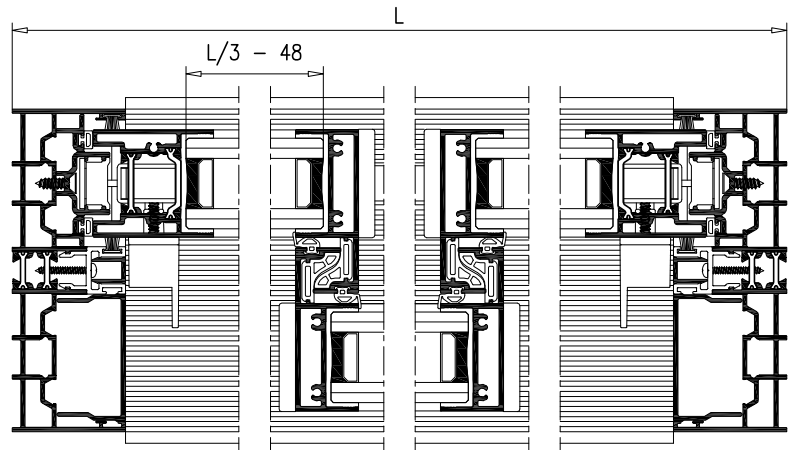
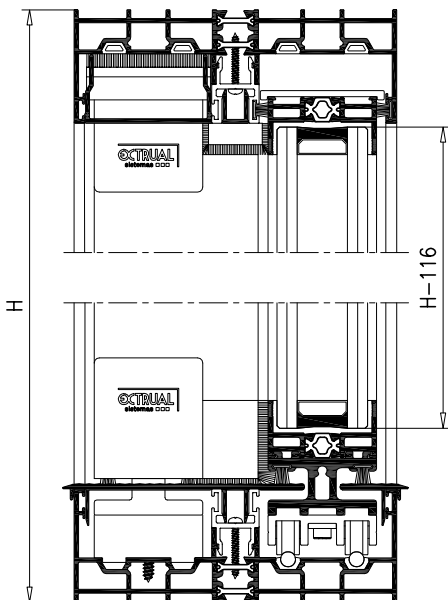



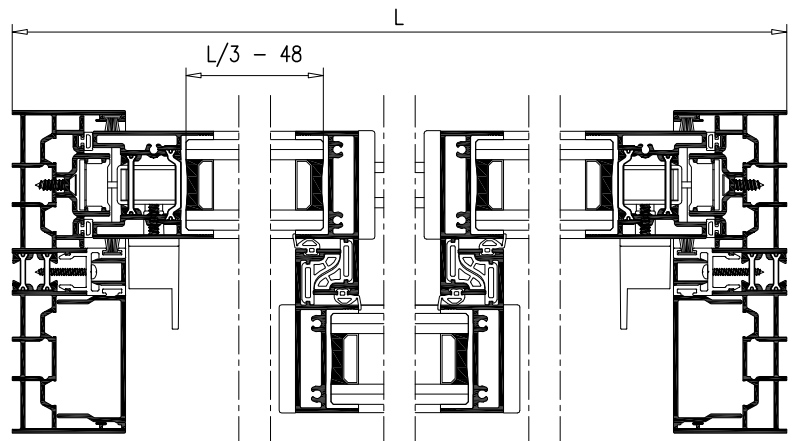
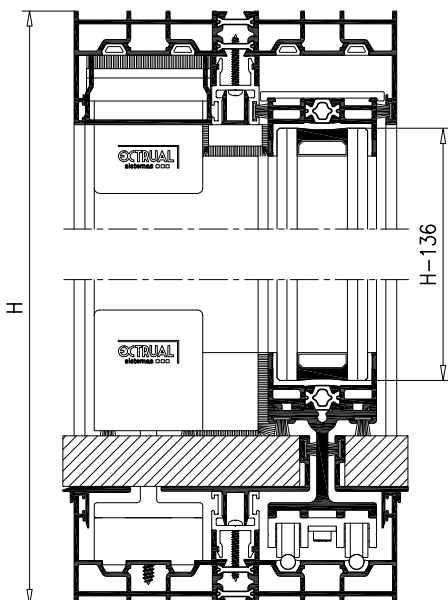









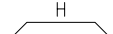
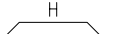
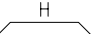

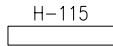
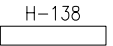
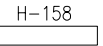

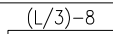
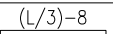
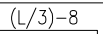
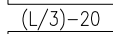
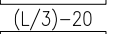
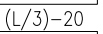

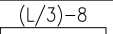
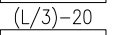

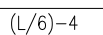
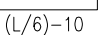

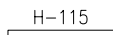
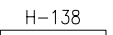
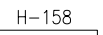

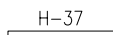
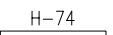
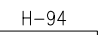

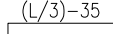
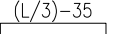
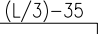
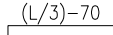
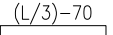
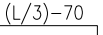
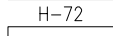
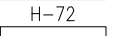
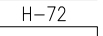

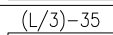
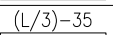
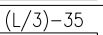
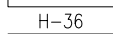
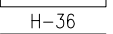
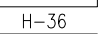

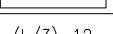

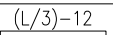

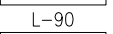

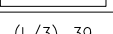

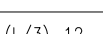

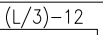
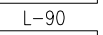

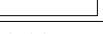

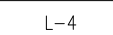
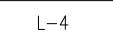
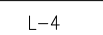
BALCONERA 2 HOJAS + FIJO CENTRAL
Marco Inferior Oculto Piso Corrido

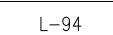
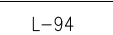

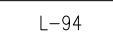
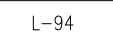
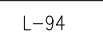
BALCONERA 2 HOJAS + FIJO CENTRAL

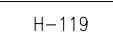
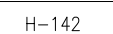
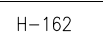
PERFILES

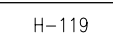
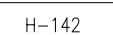
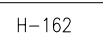
REFERENCIA	DENOMINACION	MARCO INFERIOR VISTO		MARCO INFERIOR OCULTO TAPAS ALUMINIO		MARCO INFERIOR OCULTO PISO CORRIDO	
		CANT.	CORTE	CANT.	CORTE	CANT.	CORTE
R-941	 +38.PP.020	2		2		2	
		2		2		2	
R-943		2		2		2	
R-945		4		4		4	
		2		2		2	
16.349				2			
				1			
16.651						4	
						2	
16.347		4		4		4	
16.341		2		2		2	
16.342		4		2		2	
		2		1		1	
		2		2		2	
16.343		4		2		2	
		2		2		2	
16.344*				1			
16.345*				1		2	
				1			
16.346*				2			
16.652*						1	
16.653*						1	
						1	
16.654*						2	
R-948		1		1		1	
15.686		1		1			
16.351		1		1		1	
16.348		4		4		4	
10.466		4		4		4	

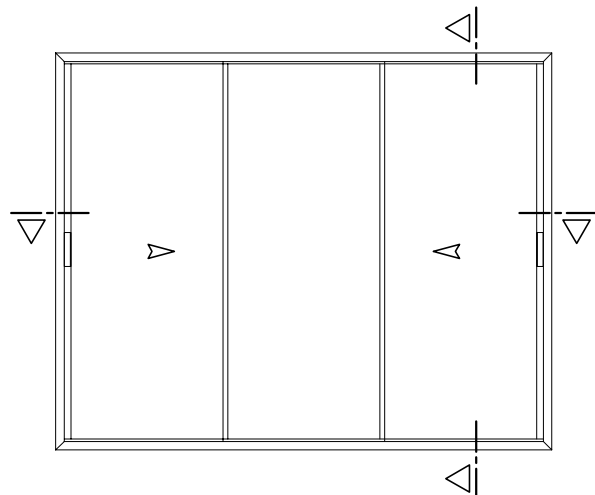

En caso de piso corrido las tapas que ocultan el marco inferior deben de ser registrables para permitir sacar las hojas en caso de necesidad.

ACCESORIOS

REFERENCIA	DENOMINACION	M.INF. VISTO	M.INF. OCULTO TAPAS ALUMINIO	M.INF. OCULTO PISO CORRIDO
		UNIDADES	UNIDADES	UNIDADES
04.AC.848	Cremona 3 puntos	2	2	2
04.AC.055.M	Cerradero	6	6	6
04.AC.056	Embellecedor Cerradero	6	6	6
04.AC.853	Manilla Dcha.	1	1	1
04.AC.854	Manilla Izda.	1	1	1
04.AC.067	Kit Hoja Lateral	2	2	2
04.AC.068	Kit Hoja Central	4		
04.AC.069	Kit H.Central M.Inf. Oculto Tapas Aluminio		4	
04.AC.078	Kit H.Central M.Inf. Oculto Piso Corrido			4
04.AC.070	Tapa H.Lateral M.Inf. Oculto Tapas Aluminio		2	
04.AC.079	Tapa H.Lateral M.Inf. Oculto Piso Corrido			2
04.AC.071	Kit Cortavientos	2		
04.AC.080	Kit Cortavientos Marco Inferior Oculto		2	2
04.AC.075	Taco Estanq. M.Inf. Oculto Tapas Aluminio		2	
04.AC.081	Taco Estanq. M.Inf. Oculto Piso Corrido			2
04.ES.083	Escuadra Marco	8	8	8
04.AC.F10	Felpudo Marco	4L+4H	2+4H	6L+4H
04.AC.F09	Felpudo Suplementos Hoja 16.349 y 16.651		2L	2L
04.JU.004.D	Junta Cierre Lateral	4H	4H	4H
04.JU.062	Junta Cruce Central	4H	4H	4H
04.JU.067	Junta Cruce Central	4H	4H	4H
04.JU.068	Junta Tapacanal Marco	2L	2L	2L
04.JU.069	Junta Carril	x2	L-200	L-200
04.AC.R150	Carril Acero Inox.	x2	L-200	L-200
04.AC.R151	Rodamiento	4	4	4
04.AC.R153	Kit Angulo Rod. M.Inf. Oculto Tapas Aluminio		2	
04.AC.R154	Kit Angulo Rod. M.Inf. Oculto Piso Corrido			2
04.AC.074	Calzo Hoja Fija	2	2	2
04.JA.004	Junta Hoja Fija	4(L/3)	2(L/3)	2(L/3)
04.TA.069	Juego Tapas Tirador	4	4	4
04.TA.070	Tapa para Canaleta	2	2	2
04.TA.071	Tapa para Solera	2	2	2
04.AC.073	Calzo Vidrio	Según dimensiones de Vidrio		

*Se indica la longitud total necesaria. Las tapas se colocan en tramos para permitir el montaje.

El perfil 16.651 se coloca deslizado en la hoja inferior en 2 trozos, para permitir sacar la hoja del marco en caso de necesidad una vez colocado el piso.

BALCONERA 1 HOJAS + 2 FIJOS LATERALES

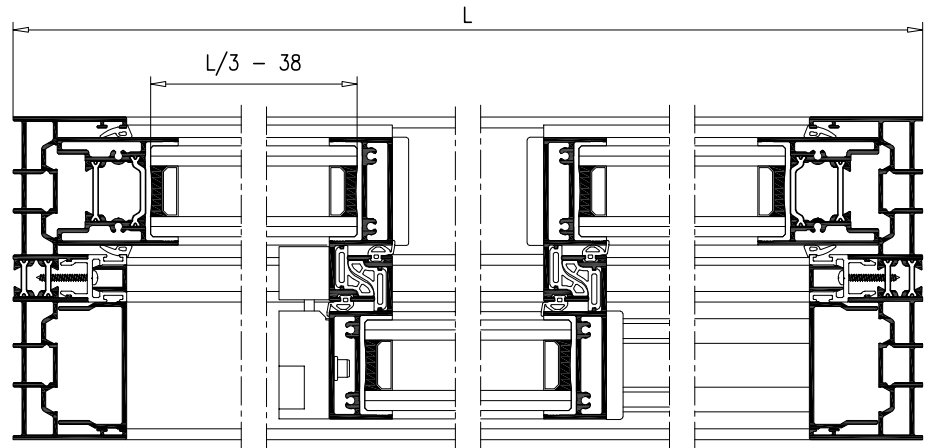
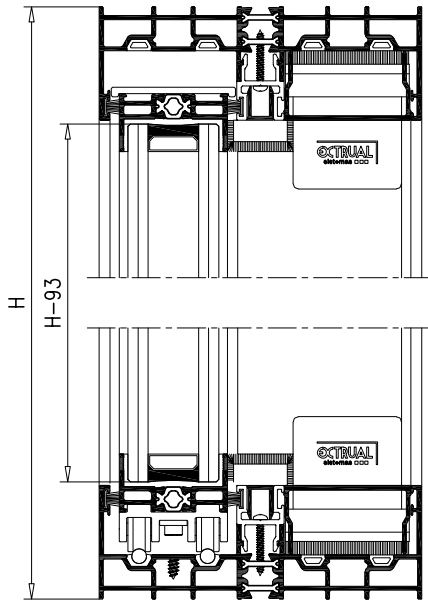

BALCONERA 1 HOJAS + 2 FIJOS LATERALES
Marco Inferior Oculto Tapas de Aluminio

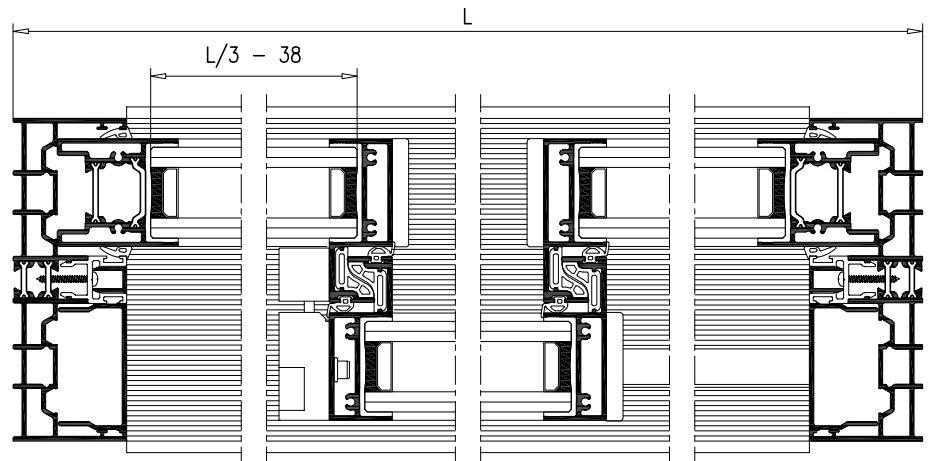
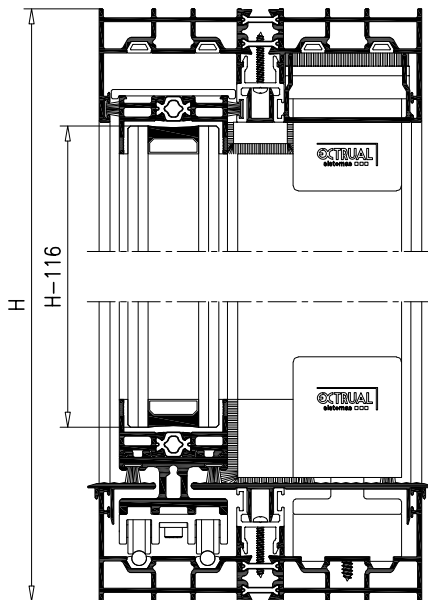



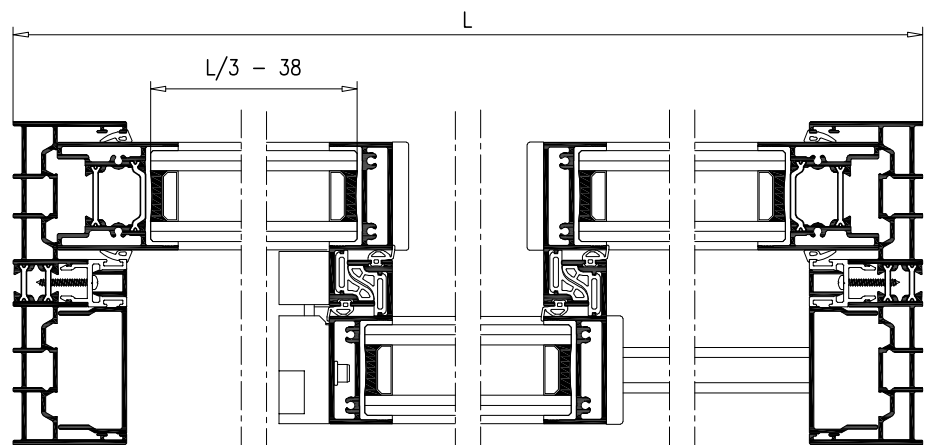
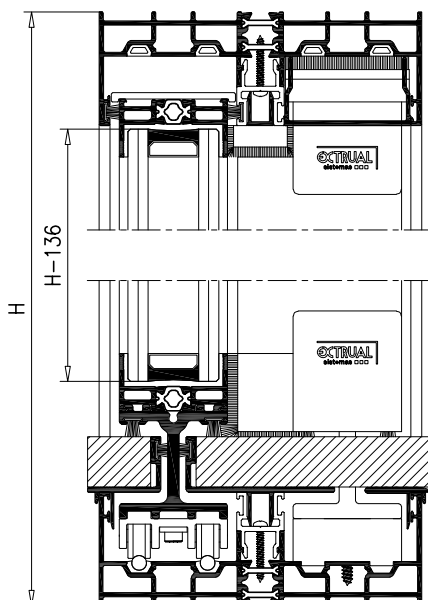





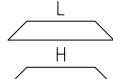
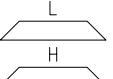
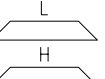

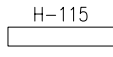
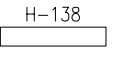
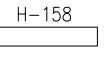

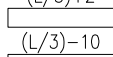
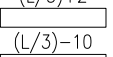
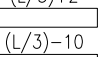
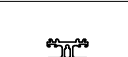
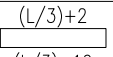

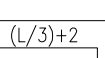
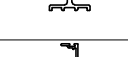
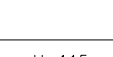
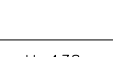
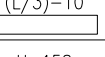
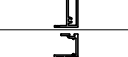
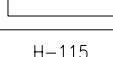
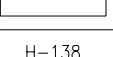
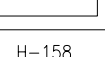

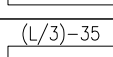
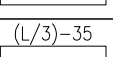
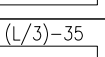
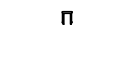
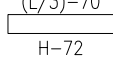
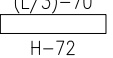
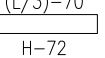

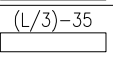
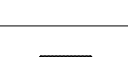
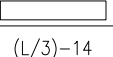

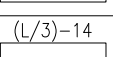

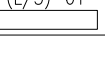
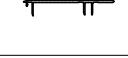

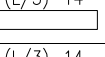

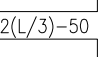

BALCONERA 1 HOJAS + 2 FIJOS LATERALES
Marco Inferior Oculto Piso Corrido

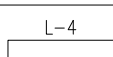
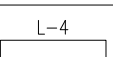
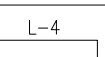

BALCONERA 1 HOJA + 2 FIJOS LATERALES

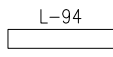
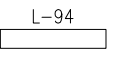
PERFILES

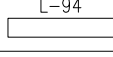
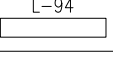
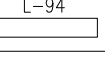
REFERENCIA	DENOMINACION	MARCO INFERIOR VISTO		MARCO INFERIOR OCULTO TAPAS ALUMINIO		MARCO INFERIOR OCULTO PISO CORRIDO	
		CANT.	CORTE	CANT.	CORTE	CANT.	CORTE
R-941	 +38.PP.020	2		2		2	
R-943		2		2		2	
R-945		4		4		4	
16.349				2			
16.651						4	
16.347		2		2		2	
16.738		2		2		2	
16.342		4		2		2	
16.343		4		2		2	
16.344*				1			
16.345*				2		1	
16.346*				1			
16.652*						1	
16.653*						2	
16.654*						1	
R-948		1		1		1	
15.686		1		1			
16.351		1		1		1	
16.348		4		4		4	
10.466		4		4		4	

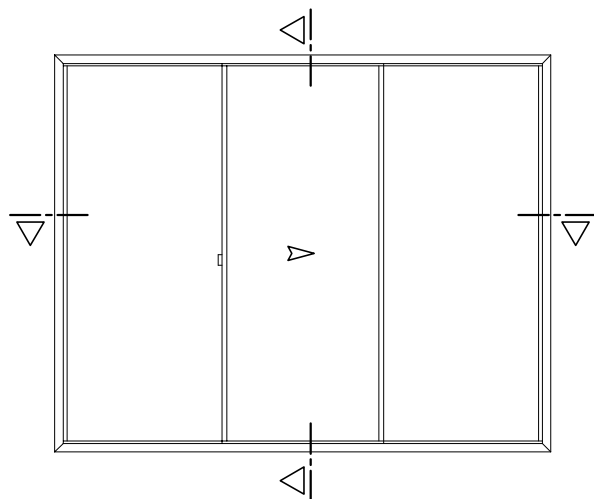

En caso de piso corrido las tapas que ocultan el marco inferior deben de ser registrables para permitir sacar las hojas en caso de necesidad.

ACCESORIOS

REFERENCIA	DENOMINACION	M.INF. VISTO	M.INF. OCULTO TAPAS ALUMINIO	M.INF. OCULTO PISO CORRIDO
		UNIDADES	UNIDADES	UNIDADES
04.AC.855	Manilla Central	1	1	1
04.AC.067	Kit Hoja Lateral	2	2	2
04.AC.068	Kit Hoja Central	4		
04.AC.069	Kit H.Central M.Inf. Oculto Tapas Aluminio		4	
04.AC.078	Kit H.Central M.Inf. Oculto Piso Corrido			4
04.AC.070	Tapa H.Lateral M.Inf. Oculto Tapas Aluminio		2	
04.AC.079	Tapa H.Lateral M.Inf. Oculto Piso Corrido			2
04.AC.071	Kit Cortavientos	2		
04.AC.080	Kit Cortavientos Marco Inferior Oculto		2	2
04.ES.083	Escuadra Marco	8	8	8
04.AC.F10	Felpudo Marco	4(L/3)	2(L/3)	4(L/3)
04.AC.F09	Felpudo Suplementos Hoja 16.349 y 16.651		2(L/3)	2(L/3)
04.JU.062	Junta Cruce Central	4H	4H	4H
04.JU.067	Junta Cruce Central	4H	4H	4H
04.JU.068	Junta Tapacanal Marco	4L	4L	4L
04.JU.069	Junta Carril	x2	2(L/3)-120	2(L/3)-120
04.AC.R150	Carril Acero Inox.	x2	2(L/3)-120	2(L/3)-120
04.AC.R151	Rodamiento	2	2	2
04.AC.R153	Kit Angulo Rod. M.Inf. Oculto Tapas Aluminio		1	
04.AC.R154	Kit Angulo Rod. M.Inf. Oculto Piso Corrido			1
04.AC.074	Calzo Hoja Fija	4	4	4
04.JA.004	Junta Hoja Fija	8(L/3)+4H	8(L/3)+4H	8(L/3)+4H
04.TA.069	Juego Tapas Tirador	4	4	4
04.TA.070	Tapa para Canaleta	2	2	2
04.TA.071	Tapa para Solera	2	2	2
04.AC.073	Calzo Vidrio	Según dimensiones de Vidrio		

*Se indica la longitud total necesaria. Las tapas se colocan en tramos para permitir el montaje.

El perfil 16.651 se coloca deslizado en la hoja inferior en 2 trozos, para permitir sacar la hoja del marco en caso de necesidad una vez colocado el piso.

BALCONERA 2 HOJAS + 2 FIJOS LATERALES

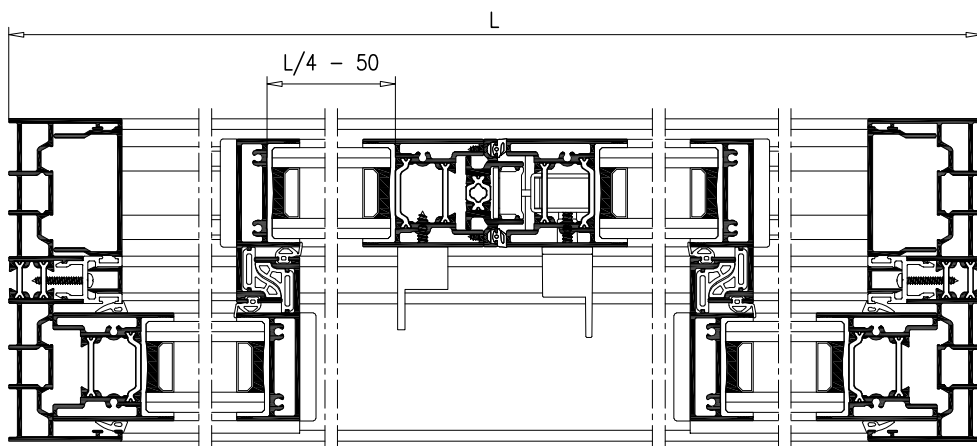
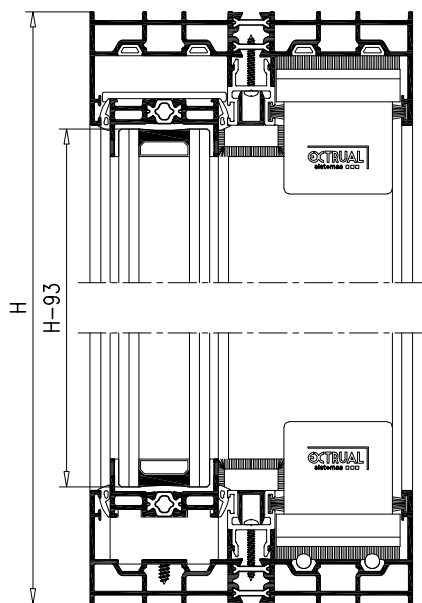

BALCONERA 2 HOJAS + 2 FIJOS LATERALES
Marco Inferior Oculto Tapas de Aluminio

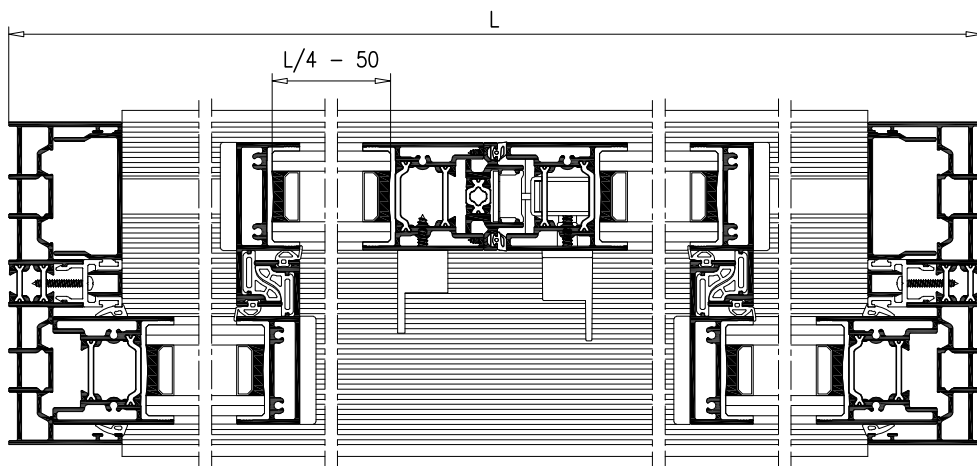
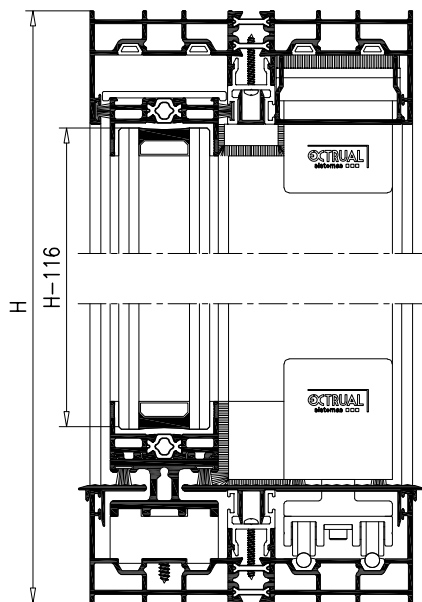



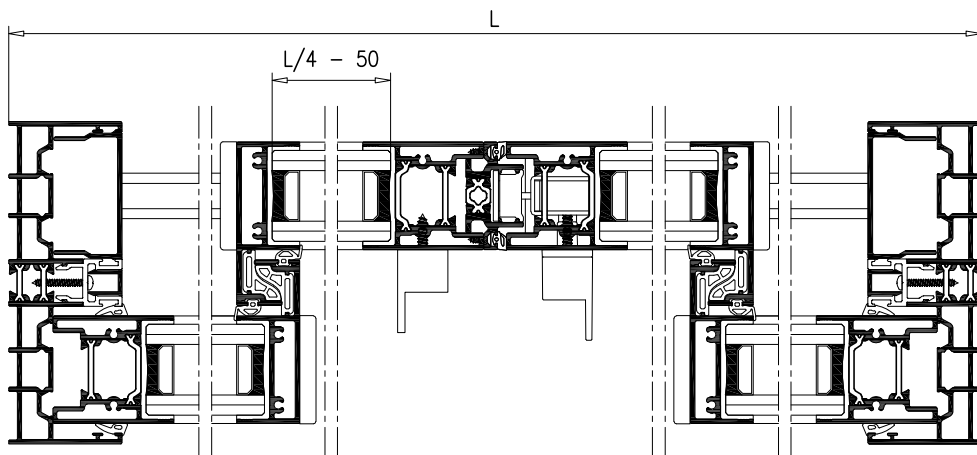
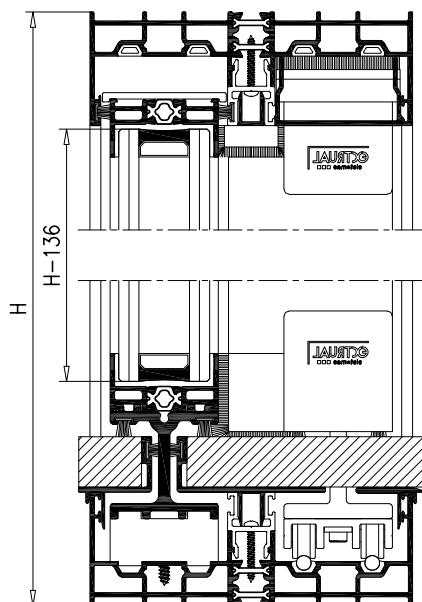















BALCONERA 2 HOJAS + 2 FIJOS LATERALES
Marco Inferior Oculto Piso Corrido

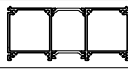

BALCONERA 2 HOJAS + 2 FIJOS LATERALES

PERFILES

REFERENCIA	DENOMINACION	MARCO INFERIOR VISTO		MARCO INFERIOR OCULTO TAPAS ALUMINIO		MARCO INFERIOR OCULTO PISO CORRIDO		
		CANT.	CORTE	CANT.	CORTE	CANT.	CORTE	
R-941	 +38.PP.020	MARCO	2 2	L H	2 2	L H	2 2	L H
R-943		HOJA LATERAL	4	H-115	4	H-138	4	H-158
R-945		HOJA SUP/INF	8	(L/4)-10	8	(L/4)-10	8	(L/4)-10
16.349		SUPLEMENT. HOJA			4	(L/4)-10		
16.651		SUPLEMENT. HOJA					4	(L/4)-10
16.347		HOJA DE CIERRE	4	H-115	4	H-138	4	H-158
R-946		CIERRE 4 HOJAS	1	H-69	1	H-94	1	H-114
16.342		TAPA CANAL	4	(L/4)-51	2	(L/4)-51	2	(L/4)-51
			2	(L/2)-38	1	(L/2)-38	1	(L/2)-38
			2	H-72	2	H-72	2	H-72
16.343		TAPA MARCO	2	(L/2)-38	1	(L/2)-38	1	(L/2)-38
			2	H-36	2	H-36	2	H-36
16.344*		TAPA CENTRAL			2	(L/4)-22		
16.345*		TAPA LATERAL			2	(L/4)-22		(L/2)-46
					1	L-90	1	
16.346*		TAPA DOBLE			1	(L/2)-46		
16.652*		TAPA CENTRAL					2	(L/4)-22
16.653*		TAPA LATERAL					2	(L/4)-22
					1	L-90	1	
16.654*		TAPA MULTIPLE					1	(L/2)-46
R-948		SOLERA	1	L-4	1	L-4	1	L-4
15.686		TAPA CANALETA	1	L-94	1	L-94		
16.351		CANALETA DRENAJE	1	L-94	1	L-94	1	L-94
16.348		REFUERZO TIRADOR	4	H-119	4	H-142	4	H-162
10.466		TAPETA TIRADOR	4	H-119	4	H-142	4	H-162

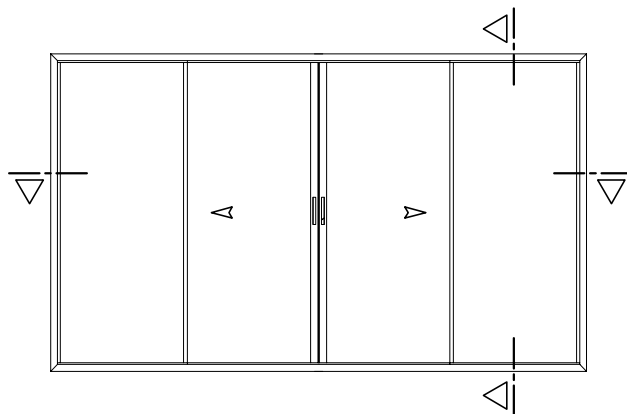

En caso de piso corrido las tapas que ocultan el marco inferior deben de ser registrables para permitir sacar las hojas en caso de necesidad.

ACCESORIOS

REFERENCIA	DENOMINACION	M.INF. VISTO	M.INF. OCULTO TAPAS ALUMINIO	M.INF. OCULTO PISO CORRIDO
		UNIDADES	UNIDADES	UNIDADES
04.AC.848	Cremona 3 puntos	1	1	1
04.AC.055.M	Cerradero	3	3	3
04.AC.056	Embellecedor Cerradero	3	3	3
04.AC.844	Manilla Izda.	1	1	1
04.AC.845	Tirador	1	1	1
04.AC.067	Kit Hoja Lateral	4	4	4
04.AC.068	Kit Hoja Central	4		
04.AC.069	Kit H.Central M.Inf. Oculto Tapas Aluminio		4	
04.AC.078	Kit H.Central M.Inf. Oculto Piso Corrido			4
04.AC.070	Tapa H.Lateral M.Inf. Oculto Tapas Aluminio		4	
04.AC.079	Tapa H.Lateral M.Inf. Oculto Piso Corrido			4
04.AC.071	Kit Cortavientos	2		
04.AC.080	Kit Cortavientos Marco Inferior Oculto		2	2
04.AC.076	Tope Inferior 4 Hojas M.Inf. Oculto		1	1
04.ES.083	Escuadra Marco	8	8	8
04.AC.F10	Felpudo Marco	4L	2L	4L
04.AC.F09	Felpudo Suplementos Hoja 16.349 y 16.651		2L	2L
04.JU.004.E	Junta Cierre 4 Hojas	2H	2H	2H
04.JU.062	Junta Cruce Central	4H	4H	4H
04.JU.067	Junta Cruce Central	4H	4H	4H
04.JU.068	Junta Tapacanal Marco	2L	2L	2L
04.JU.069	Junta Carril	x2	L-200	L-200
04.AC.R150	Carril Acero Inox.	x2	L-200	L-200
04.AC.R151	Rodamiento	4	4	4
04.AC.R153	Kit Angulo Rod. M.Inf. Oculto Tapas Aluminio		2	
04.AC.R154	Kit Angulo Rod. M.Inf. Oculto Piso Corrido			2
04.AC.074	Calzo Hoja Fija	4	4	4
04.JA.004	Junta Hoja Fija	2L+4H	L+4H	L+4H
04.TA.069	Juego Tapas Tirador	4	4	4
04.TA.070	Tapa para Canaleta	2	2	2
04.TA.071	Tapa para Solera	2	2	2
04.AC.073	Calzo Vidrio	Según dimensiones de Vidrio		

*Se indica la longitud total necesaria. Las tapas se colocan en tramos para permitir el montaje.

BALCONERA 4 HOJAS Marco 2 Carriles

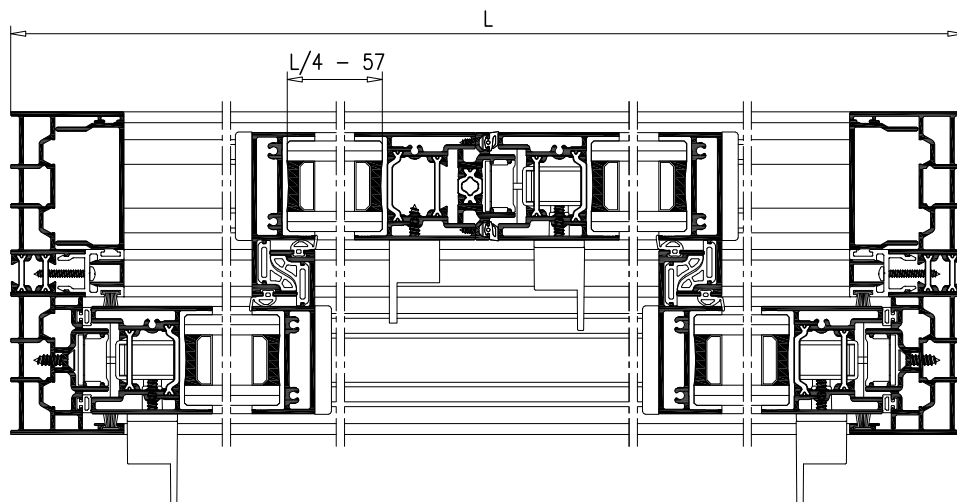
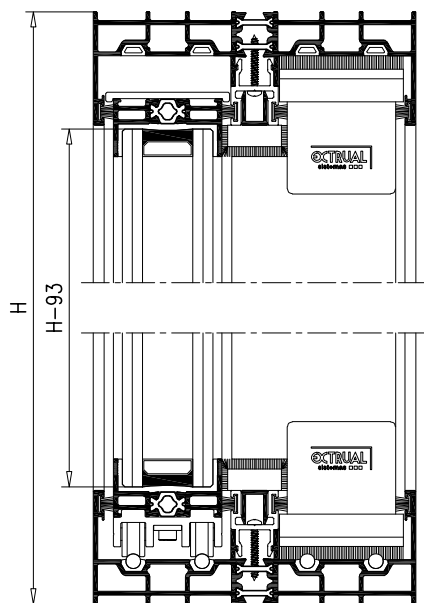

**BALCONERA 4 HOJAS Marco 2 Carriles
Marco Inferior Oculto Tapas de Aluminio**

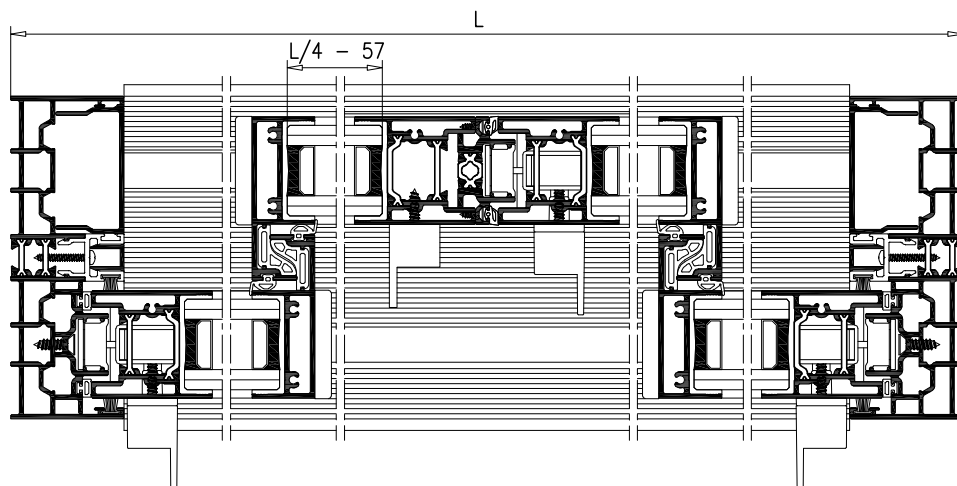
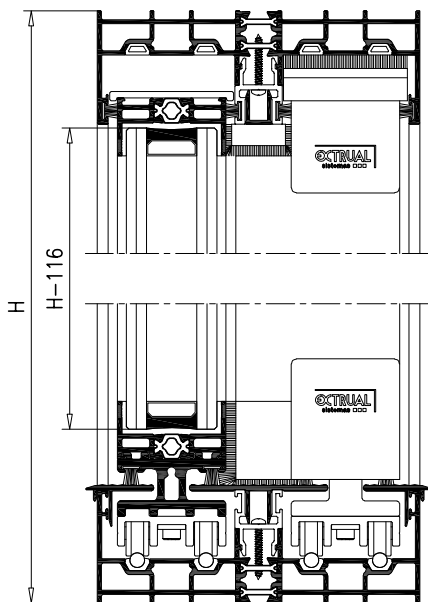

**BALCONERA 4 HOJAS Marco 2 Carriles
Marco Inferior Oculto Piso Corrido**

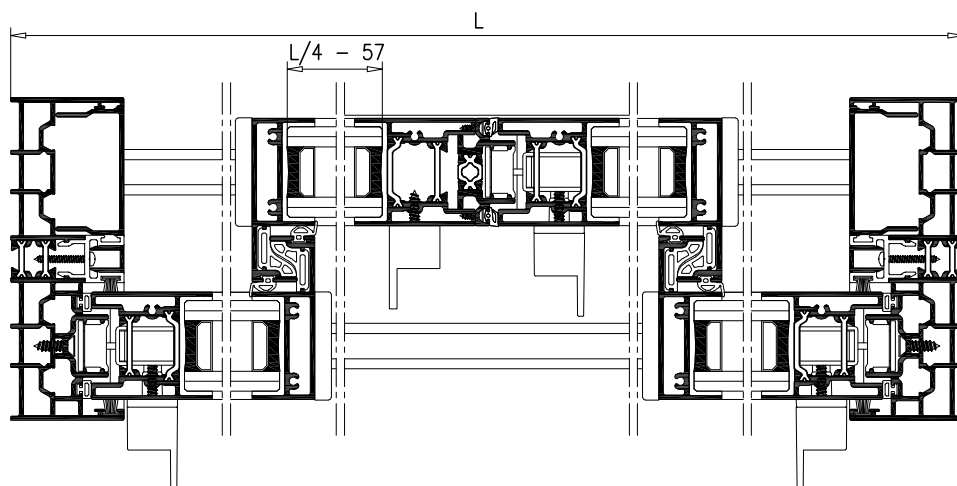
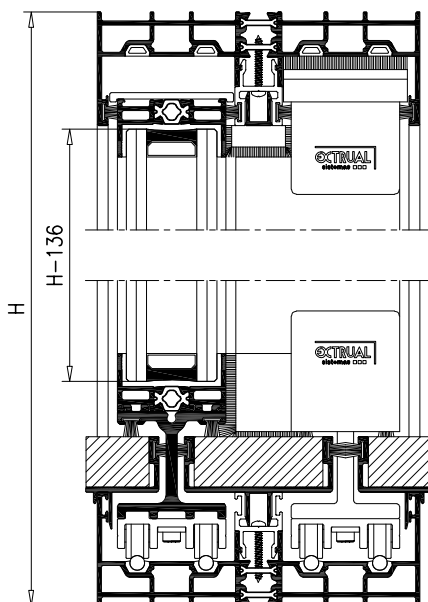

BALCONERA 4 HOJAS Marco 2 Carriles

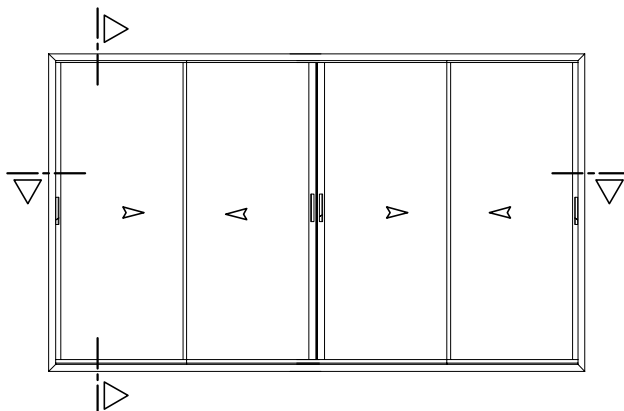

PERFILES

REFERENCIA	DENOMINACION	MARCO INFERIOR VISTO		MARCO INFERIOR OCULTO TAPAS ALUMINIO		MARCO INFERIOR OCULTO PISO CORRIDO	
		CANT.	CORTE	CANT.	CORTE	CANT.	CORTE
R-941	MARCO +38.PP.020	2		2		2	
		2		2		2	
R-943	HOJA LATERAL	4	H-115	4	H-138	4	H-158
R-945	HOJA SUP/INF	8	(L/4)-17	8	(L/4)-17	8	(L/4)-17
16.349	SUPLEMENT. HOJA			4	(L/4)-17		
16.651	SUPLEMENT. HOJA					4	(L/4)-17
16.347	HOJA DE CIERRE	4	H-115	4	H-138	4	H-158
16.341	CIERRE LATERAL	2	H-37	2	H-74	2	H-94
R-946	CIERRE 4 HOJAS	1	H-69	1	H-94	1	H-114
16.342	TAPA CANAL	4	(L/4)-44	2	(L/4)-44	2	(L/4)-44
		2	(L/2)-53	1	(L/2)-53	1	(L/2)-53
		2	H-72	2	H-72	2	H-72
16.343	TAPA MARCO	2	H-36	2	H-36	2	H-36
16.344*	TAPA CENTRAL			1	L-90		
16.345*	TAPA LATERAL			2	L-90		
16.652*	TAPA CENTRAL					1	L-90
16.653*	TAPA LATERAL					2	L-90
R-948	SOLERA	1	L-4	1	L-4	1	L-4
15.686	TAPA CANALETA	1	L-94	1	L-94		
16.351	CANALETA DRENAJE	1	L-94	1	L-94	1	L-94
16.348	REFUERZO TIRADOR	4	H-119	4	H-142	4	H-162
10.466	TAPETA TIRADOR	4	H-119	4	H-142	4	H-162

ACCESORIOS

REFERENCIA	DENOMINACION	M.INF. VISTO	M.INF. OCULTO TAPAS ALUMINIO	M.INF. OCULTO PISO CORRIDO
		UNIDADES	UNIDADES	UNIDADES
04.AC.848	Cremona 3 puntos	3	3	3
04.AC.055.M	Cerradero	9	9	9
04.AC.056	Embellecedor Cerradero	9	9	9
04.AC.843	Manilla Dcha.	2	2	2
04.AC.844	Manilla Izda.	1	1	1
04.AC.845	Tirador	1	1	1
04.AC.067	Kit Hoja Lateral	4	4	4
04.AC.068	Kit Hoja Central	4		
04.AC.069	Kit H.Central M.Inf. Oculto Tapas Aluminio		4	
04.AC.078	Kit H.Central M.Inf. Oculto Piso Corrido			4
04.AC.070	Tapa H.Lateral M.Inf. Oculto Tapas Aluminio		4	
04.AC.079	Tapa H.Lateral M.Inf. Oculto Piso Corrido			4
04.AC.071	Kit Cortavientos	2		
04.AC.080	Kit Cortavientos Marco Inferior Oculto		2	2
04.AC.076	Tope Inferior 4 Hojas M.Inf. Oculto		1	1
04.AC.075	Taco Estanq. M.Inf. Oculto Tapas Aluminio		1	
04.AC.081	Taco Estanq. M.Inf. Oculto Piso Corrido			1
04.ES.083	Escuadra Marco	8	8	8
04.AC.F10	Felpudo Marco	4L+4H	2L+4H	4L+4H
04.AC.F09	Felpudo Suplementos Hoja 16.349 y 16.651		2L	2L
04.JU.004.D	Junta Cierre Lateral	4H	4H	4H
04.JU.004.E	Junta Cierre 4 Hojas	2H	2H	2H
04.JU.062	Junta Cruce Central	4H	4H	4H
04.JU.067	Junta Cruce Central	4H	4H	4H
04.JU.068	Junta Tapa Canal Marco	4L	4L	4L
04.JU.069	Junta Carril	x4	L-200	L-200
04.AC.R150	Carril Acero Inox.	x4	L-200	L-200
04.AC.R151	Rodamiento	8	8	8
04.AC.R153	Kit Angulo Rod. M.Inf. Oculto Tapas Aluminio		4	
04.AC.R154	Kit Angulo Rod. M.Inf. Oculto Piso Corrido			4
04.TA.069	Juego Tapas Tirador	4	4	4
04.TA.070	Tapa para Canaleta	2	2	2
04.TA.071	Tapa para Solera	2	2	2
04.AC.073	Calzo Vidrio	Según dimensiones de Vidrio		

*Se indica la longitud total necesaria. Las tapas se colocan en tramos para permitir el montaje.

BALCONERA 4 HOJAS Marco 2 Carriles

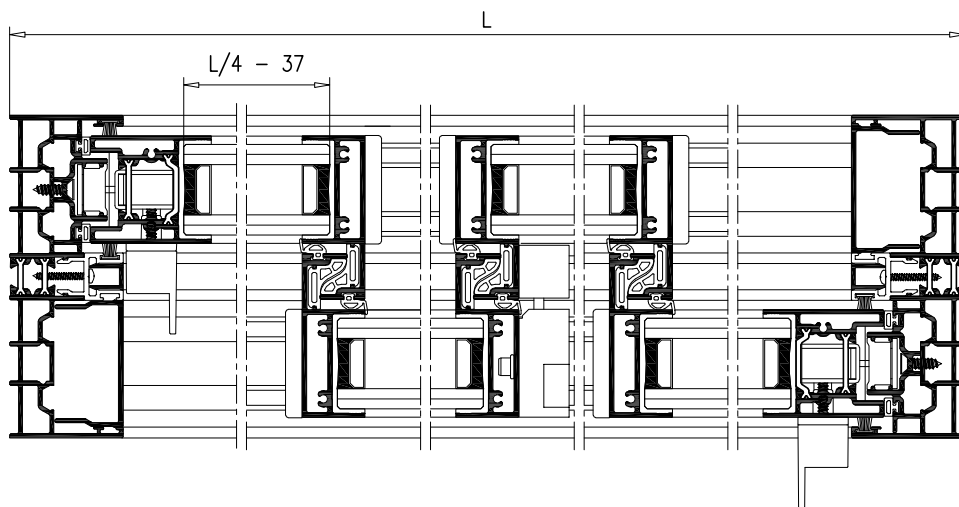
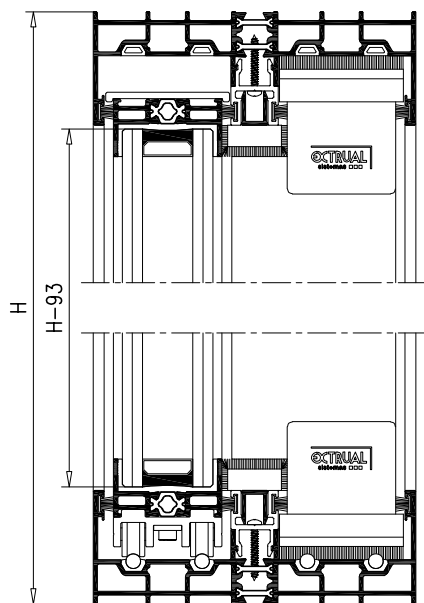

**BALCONERA 4 HOJAS Marco 2 Carriles
Marco Inferior Oculto Tapas de Aluminio**

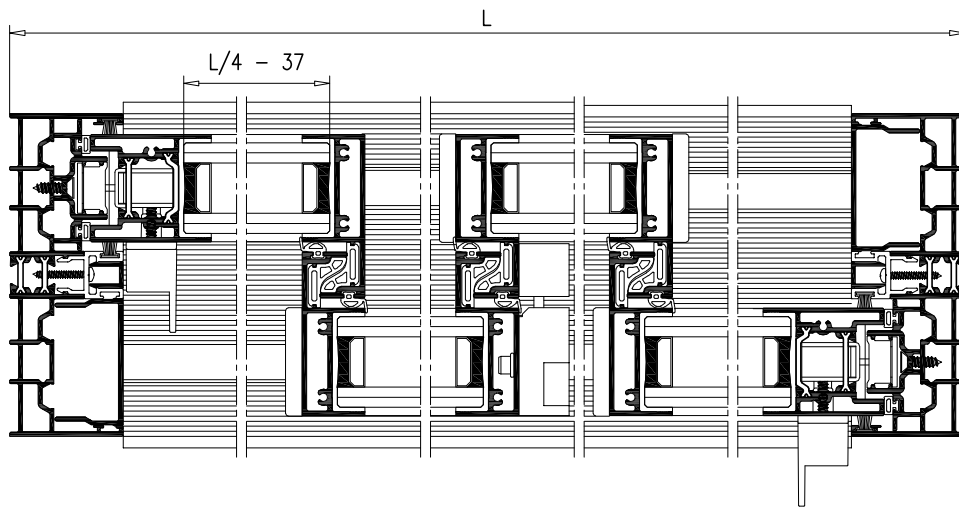
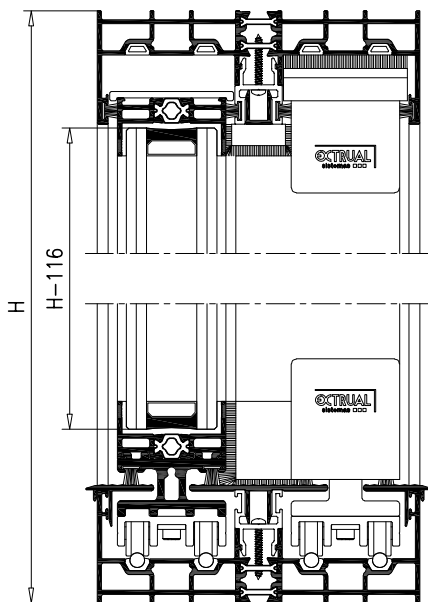



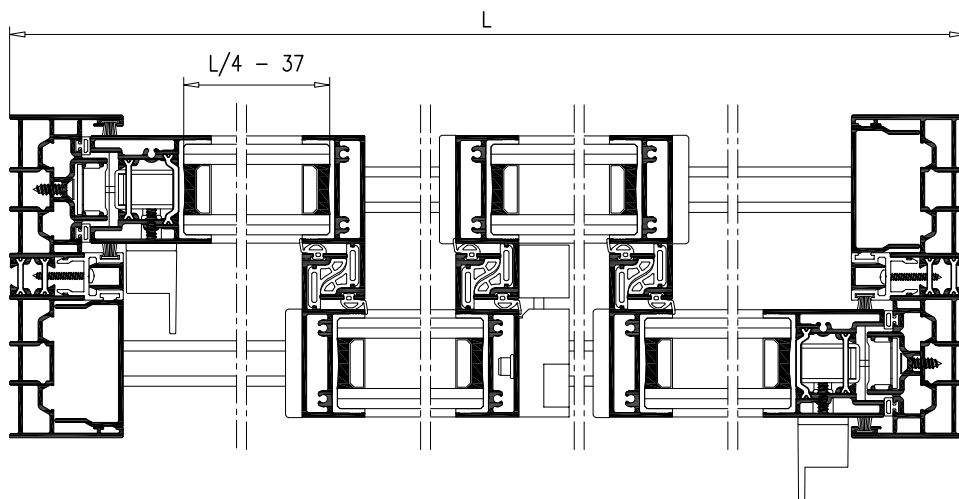
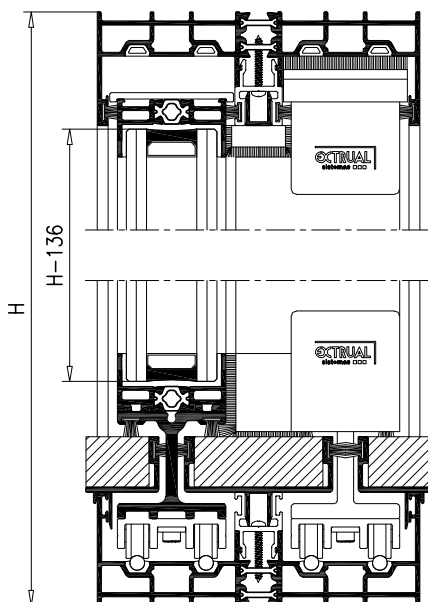



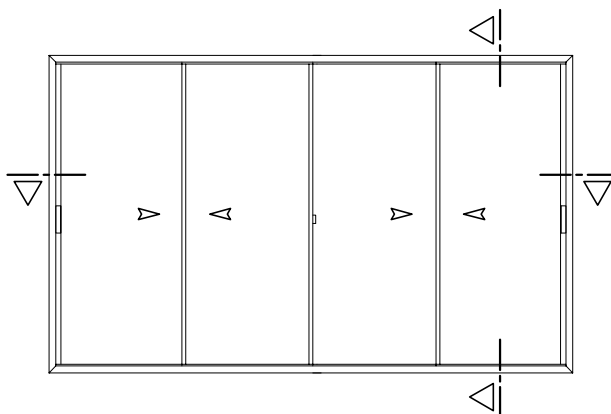





























































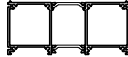







**BALCONERA 4 HOJAS Marco 2 Carriles
Marco Inferior Oculto Piso Corrido**



BALCONERA 4 HOJAS Marco 2 Carriles



PERFILES

REFERENCIA	DENOMINACION	MARCO INFERIOR VISTO		MARCO INFERIOR OCULTO TAPAS ALUMINIO		MARCO INFERIOR OCULTO PISO CORRIDO	
		CANT.	CORTE	CANT.	CORTE	CANT.	CORTE
R-941	MARCO  +38.PP.020	2		2		2	
		2		2		2	
R-943	HOJA LATERAL 	2	H-115 	2	H-138 	2	H-158 
R-945	HOJA SUP/INF 	4	(L/4)+3 	4	(L/4)+3 	4	(L/4)+3 
		4	(L/4)-9 	4	(L/4)-9 	4	(L/4)-9 
16.349	SUPLEMENT. HOJA 			2	(L/4)+3 		
				2	(L/4)-9 		
16.651	SUPLEMENT. HOJA 					2	(L/4)+3 
						2	(L/4)-9 
16.347	HOJA DE CIERRE 	4	H-115 	4	H-138 	4	H-158 
16.738	HOJA INVERTIDA 	2	H-115 	2	H-138 	2	H-158 
16.341	CIERRE LATERAL 	2	H-37 	2	H-74 	2	H-94 
16.342	TAPA CANAL 	4	(L/4)-44 	2	(L/4)-44 	2	(L/4)-44 
		2	(L/2)-53 	1	(L/2)-53 	1	(L/2)-53 
		2	H-72 	2	H-72 	2	H-72 
16.343	TAPA MARCO 	2	H-36 	2	H-36 	2	H-36 
16.344*	TAPA CENTRAL 			1	L-90 		
16.345*	TAPA LATERAL 			2	L-90 		
16.652*	TAPA CENTRAL 					1	L-90 
16.653*	TAPA LATERAL 					2	L-90 
R-948	SOLERA 	1	L-4 	1	L-4 	1	L-4 
15.686	TAPA CANALETA 	1	L-94 	1	L-94 		
16.351	CANALETA DRENAJE 	1	L-94 	1	L-94 	1	L-94 
16.348	REFUERZO TIRADOR 	6	H-119 	6	H-142 	6	H-162 
10.466	TAPETA TIRADOR 	6	H-119 	6	H-142 	6	H-162 

ACCESORIOS

REFERENCIA	DENOMINACION	M.INF. VISTO	M.INF. OCULTO TAPAS ALUMINIO	M.INF. OCULTO PISO CORRIDO
		UNIDADES	UNIDADES	UNIDADES
04.AC.848	Cremona 3 puntos	2	2	2
04.AC.055.M	Cerradero	6	6	6
04.AC.056	Embellecedor Cerradero	6	6	6
04.AC.853	Manilla Dcha.	1	1	1
04.AC.854	Manilla Izda.	1	1	1
04.AC.855	Manilla Central	1	1	1
04.AC.067	Kit Hoja Lateral	2	2	2
04.AC.068	Kit Hoja Central	6		
04.AC.069	Kit H.Central M.Inf. Oculto Tapas Aluminio		6	
04.AC.070	Kit H.Central M.Inf. Oculto Piso Corrido			6
04.AC.070	Tapa H.Lateral M.Inf. Oculto Tapas Aluminio		2	
04.AC.079	Tapa H.Lateral M.Inf. Oculto Piso Corrido			2
04.AC.071	Kit Cortavientos	3		
04.AC.080	Kit Cortavientos Marco Inferior Oculto		3	3
04.AC.075	Taco Estanq. M.Inf. Oculto Tapas Aluminio		2	
04.AC.081	Taco Estanq. M.Inf. Oculto Piso Corrido			2
04.ES.083	Escuadra Marco	8	8	8
04.AC.F10	Felpudo Marco	4L+4H	2L+4H	4L+4H
04.AC.F09	Felpudo Suplementos Hoja 16.349 y 16.651		2L	2L
04.JU.004.D	Junta Cierre Lateral	4H	4H	4H
04.JU.062	Junta Cruce Central	6H	6H	6H
04.JU.067	Junta Cruce Central	6H	6H	6H
04.JU.068	Junta Tapa Canal Marco	4L	4L	4L
04.JU.069	Junta Carril	x4	L-200	L-200
04.AC.R150	Carril Acero Inox.	x4	L-200	L-200
04.AC.R151	Rodamiento	8	8	8
04.AC.R153	Kit Angulo Rod. M.Inf. Oculto Tapas Aluminio		4	
04.AC.R154	Kit Angulo Rod. M.Inf. Oculto Piso Corrido			4
04.TA.069	Juego Tapas Tirador	6	6	6
04.TA.070	Tapa para Canaleta	2	2	2
04.TA.071	Tapa para Solera	2	2	2
04.AC.073	Calzo Vidrio	Según dimensiones de Vidrio		

*Se indica la longitud total necesaria. Las tapas se colocan en tramos para permitir el montaje.

BALCONERA 3 HOJAS Marco 3 Carriles

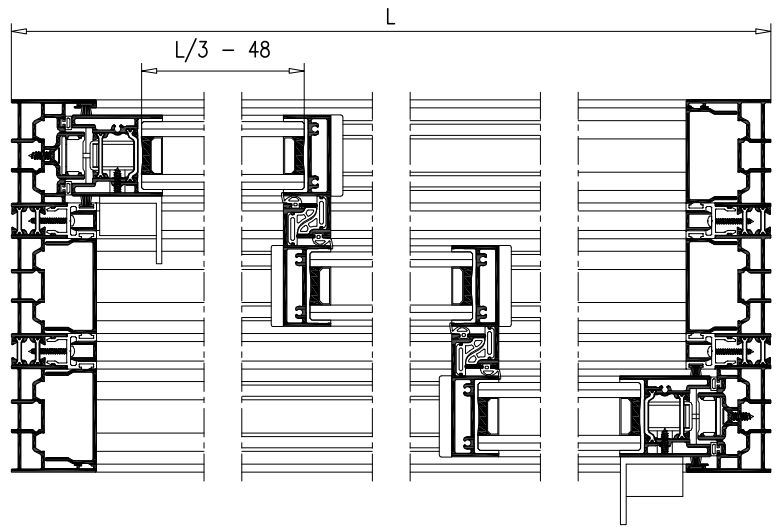
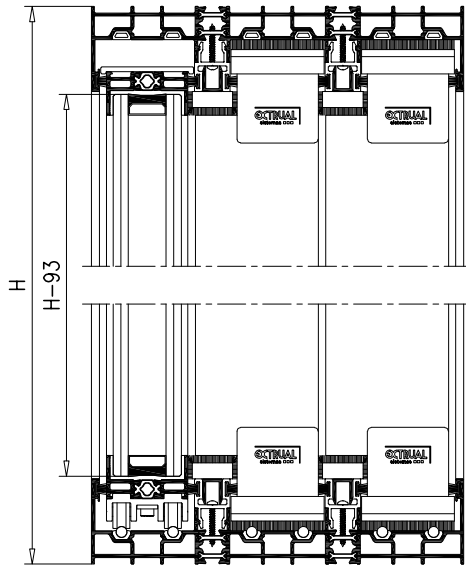

**BALCONERA 3 HOJAS Marco 3 Carriles
Marco Inferior Oculto Tapas de Aluminio**

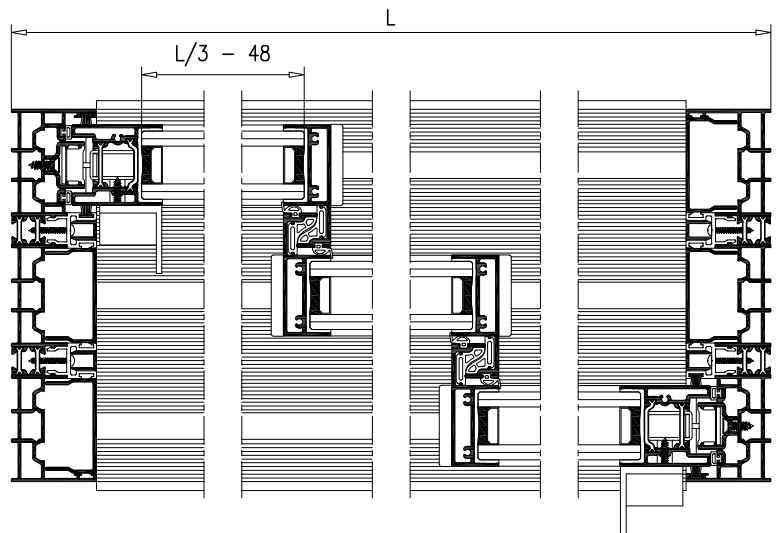
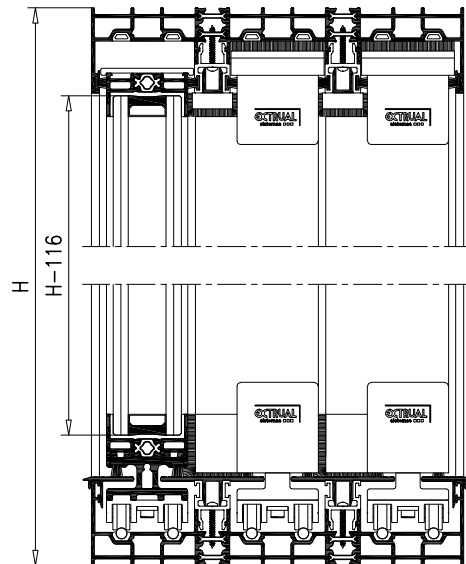



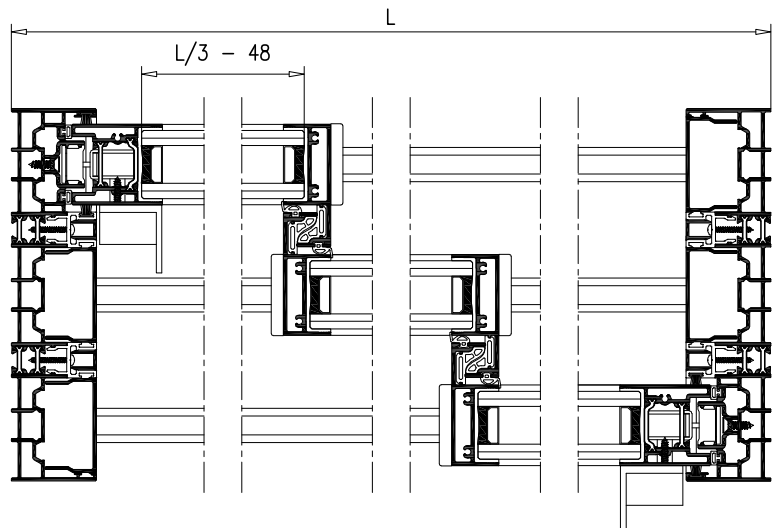
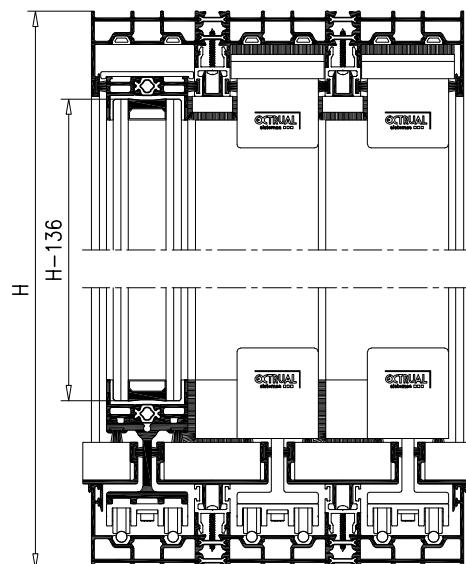





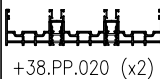
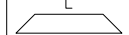
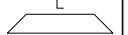
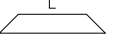
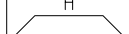
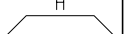
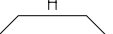

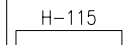
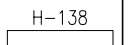
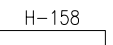

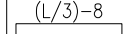
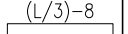
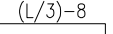
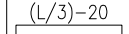
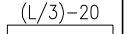
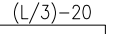

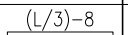
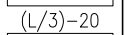

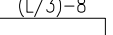
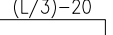

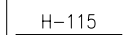
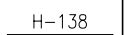
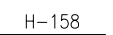

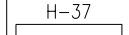
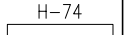
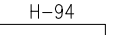

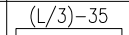
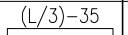
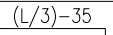
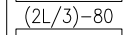
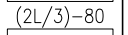
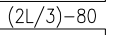
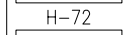
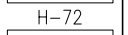
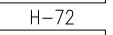

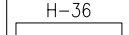
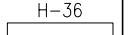
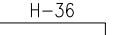

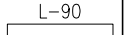

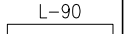

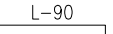

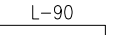
**BALCONERA 3 HOJAS Marco 3 Carriles
Marco Inferior Oculto Piso Corrido**

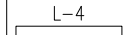
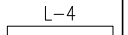
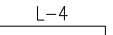

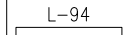
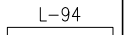
BALCONERA 3 HOJAS Marco 3 Carriles

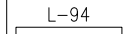
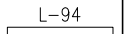
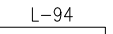
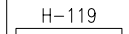
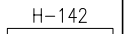
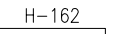
PERFILES

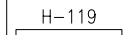
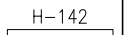
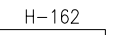
REFERENCIA	DENOMINACION	MARCO INFERIOR VISTO		MARCO INFERIOR OCULTO TAPAS ALUMINIO		MARCO INFERIOR OCULTO PISO CORRIDO	
		CANT.	CORTE	CANT.	CORTE	CANT.	CORTE
R-942	 MARCO +38.PP.020 (x2)	2		2		2	
		2		2		2	
R-943	 HOJA LATERAL	2		2		2	
R-945	 HOJA SUP/INF	4		4		4	
		2		2		2	
16.349	 SUPLEMENT. HOJA			2			
				1			
16.651	 SUPLEMENT. HOJA					2	
						1	
16.347	 HOJA DE CIERRE	4		4		4	
16.341	 CIERRE LATERAL	2		2		2	
16.342	 TAPA CANAL	4		2		2	
		4		2		2	
		4		4		4	
16.343	 TAPA MARCO	4		4		4	
16.344*	 TAPA CENTRAL			2			
16.345*	 TAPA LATERAL			2			
16.652*	 TAPA CENTRAL					2	
16.653*	 TAPA LATERAL					2	
R-949	 SOLERA	1		1		1	
15.686	 TAPA CANALETA	1		1			
16.351	 CANALETA DRENAJE	1		1		1	
16.348	 REFUERZO TIRADOR	4		4		4	
10.466	 TAPETA TIRADOR	4		4		4	

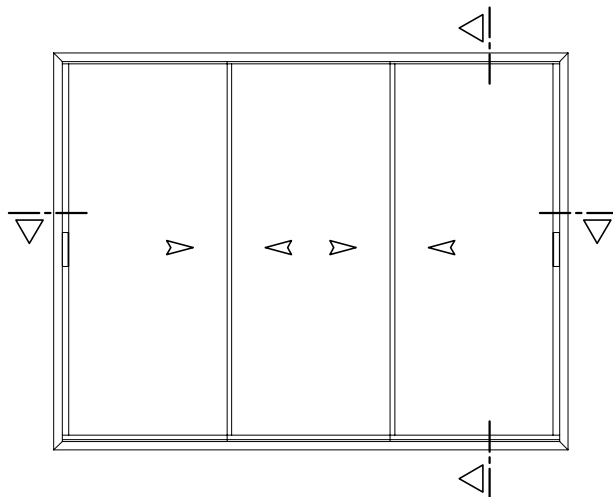

ACCESORIOS

REFERENCIA	DENOMINACION	M.INF. VISTO	M.INF. OCULTO TAPAS ALUMINIO	M.INF. OCULTO PISO CORRIDO
		UNIDADES	UNIDADES	UNIDADES
04.AC.848	Cremona 3 puntos	2	2	2
04.AC.055.M	Cerradero	6	6	6
04.AC.056	Embellecedor Cerradero	6	6	6
04.AC.853	Manilla Dcha.	1	1	1
04.AC.854	Manilla Izda.	1	1	1
04.AC.067	Kit Hoja Lateral	2	2	2
04.AC.068	Kit Hoja Central	4		
04.AC.069	Kit H.Central M.Inf. Oculto Tapas Aluminio		4	
04.AC.078	Kit H.Central M.Inf. Oculto Piso Corrido			4
04.AC.070	Tapa H.Lateral M.Inf. Oculto Tapas Aluminio		2	
04.AC.079	Tapa H.Lateral M.Inf. Oculto Piso Corrido			2
04.AC.071	Kit Cortavientos	2		
04.AC.080	Kit Cortavientos Marco Inferior Oculto		2	2
04.AC.075	Taco Estanq. M.Inf. Oculto Tapas Aluminio		2	
04.AC.081	Taco Estanq. M.Inf. Oculto Piso Corrido			2
04.ES.083	Escuadra Marco	12	12	12
04.AC.F10	Felpudo Marco	4L+4H	2L+4H	8L+4H
04.AC.F09	Felpudo Suplementos Hoja 16.349 y 16.651		2L	2L
04.JU.004.D	Junta Cierre Lateral	4H	4H	4H
04.JU.062	Junta Cruce Central	4H	4H	4H
04.JU.067	Junta Cruce Central	4H	4H	4H
04.JU.068	Junta Tapacanal Marco	6L	6L	6L
04.JU.069	Junta Carril	x6	L-200	L-200
04.AC.R150	Carril Acero Inox.	x6	L-200	L-200
04.AC.R151	Rodamiento	6	6	6
04.AC.R153	Kit Angulo Rod. M.Inf. Oculto Tapas Aluminio		3	
04.AC.R154	Kit Angulo Rod. M.Inf. Oculto Piso Corrido			3
04.TA.069	Juego Tapas Tirador	4	4	4
04.TA.070	Tapa para Canaleta	2	2	2
04.TA.072	Tapa para Solera	2	2	2
04.AC.073	Calzo Vidrio	Según dimensiones de Vidrio		

*Se indica la longitud total necesaria. Las tapas se colocan en tramos para permitir el montaje.

BALCONERA 6 HOJAS Marco 3 Carriles

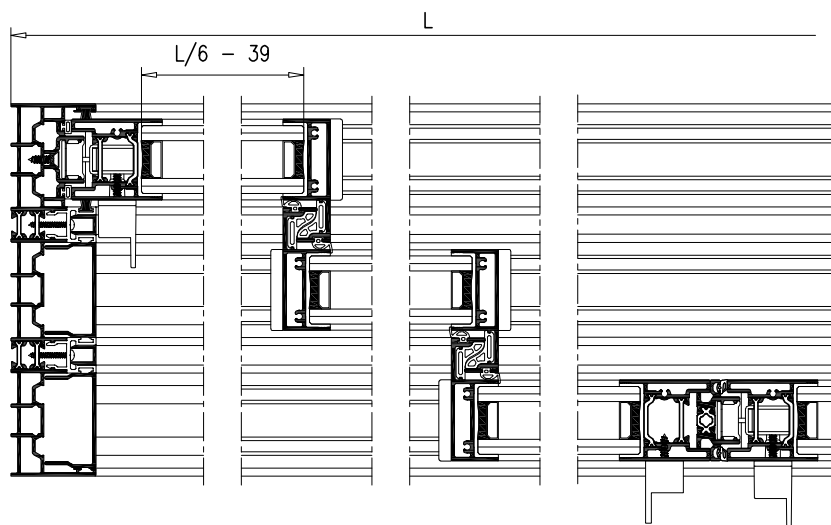
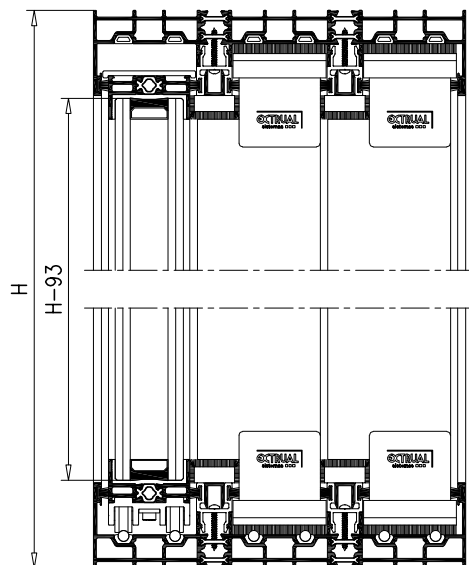

**BALCONERA 6 HOJAS Marco 3 Carriles
Marco Inferior Oculto Tapas de Aluminio**

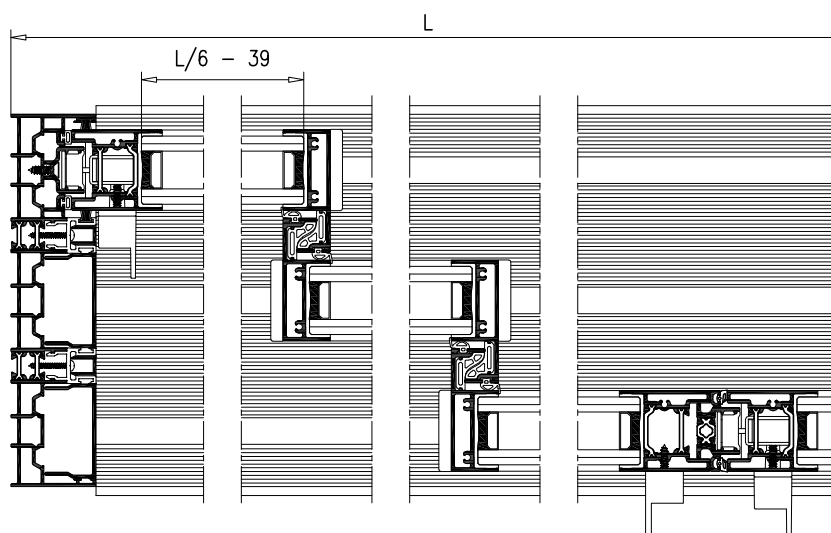
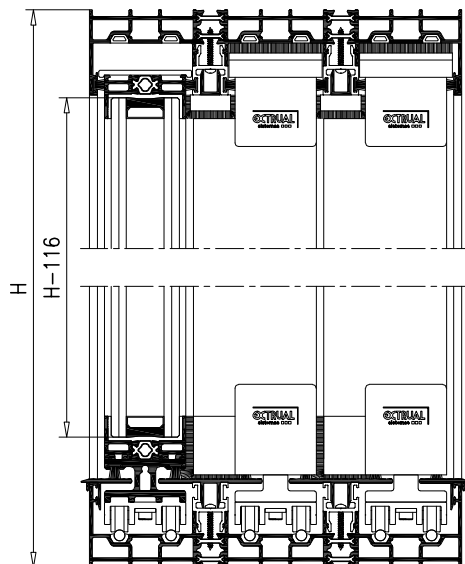



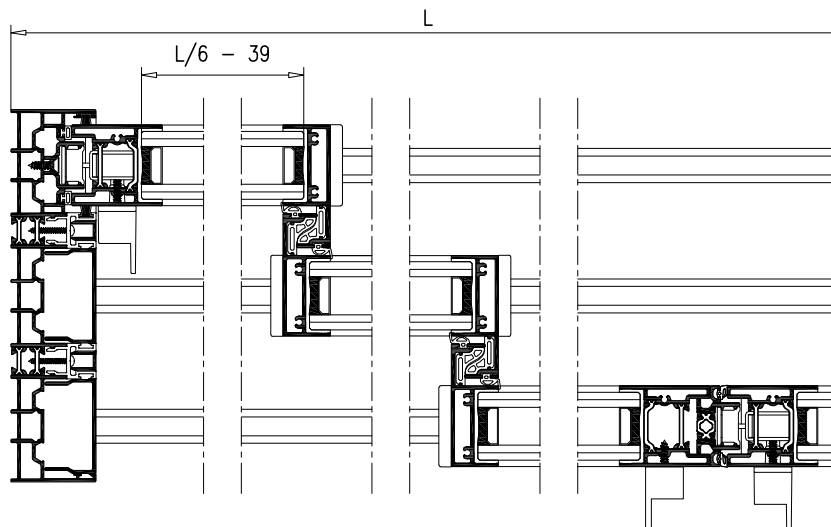
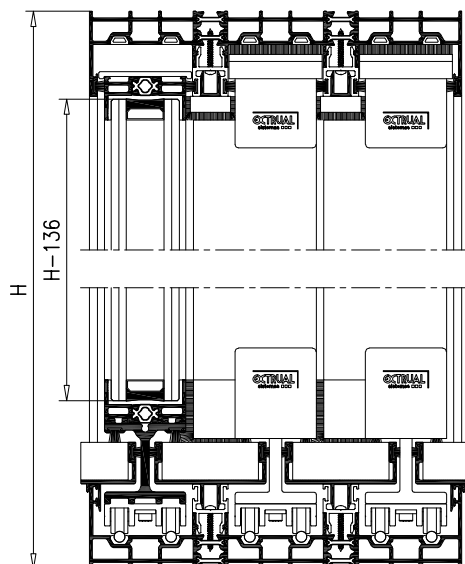





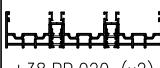



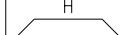
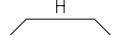









**BALCONERA 6 HOJAS Marco 3 Carriles
Marco Inferior Oculto Piso Corrido**

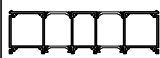

BALCONERA 6 HOJAS Marco 3 Carriles

PERFILES

REFERENCIA	DENOMINACION	MARCO INFERIOR VISTO		MARCO INFERIOR OCULTO TAPAS ALUMINIO		MARCO INFERIOR OCULTO PISO CORRIDO	
		CANT.	CORTE	CANT.	CORTE	CANT.	CORTE
R-942	 +38.PP.020 (x2)	2		2		2	
		2		2		2	
R-943		4	H-115	4	H-138	4	H-158
R-945		8	(L/6)+1	8	(L/6)+1	8	(L/6)+1
		4	(L/6)-11	4	(L/6)-11	4	(L/6)-11
16.349				4	(L/6)+1		
				2	(L/6)-11		
16.651						4	(L/6)+1
						2	(L/6)-11
16.347		8	H-115	8	H-138	8	H-158
16.341		2	H-37	2	H-74	2	H-94
R-946		1	H-69	1	H-94	1	H-114
16.342		4	(L/6)-26	2	(L/6)-26	2	(L/6)-26
		2	(4L/6)-89	1	(4L/6)-89	1	(4L/6)-89
		4	(L/3)-62	2	(L/3)-62	2	(L/3)-62
		2	(L/3)-17	1	(L/3)-17	1	(L/3)-17
		4	H-72	4	H-72	4	H-72
16.343		4	H-36	4	H-36	4	H-36
16.344*				2	L-90		
16.345*				2	L-90		
16.652*						2	L-90
16.653*						2	L-90
R-949		1	L-4	1	L-4	1	L-4
15.686		1	L-94	1	L-94		
16.351		1	L-94	1	L-94	1	L-94
16.348		10	H-119	10	H-142	10	H-162
10.466		10	H-119	10	H-142	10	H-162

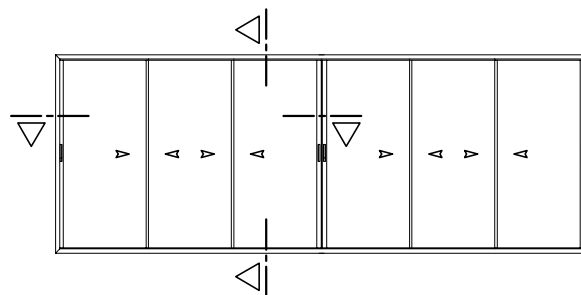

ACCESORIOS

REFERENCIA	DENOMINACION	M.INF. VISTO	M.INF. OCULTO TAPAS ALUMINIO	M.INF. OCULTO PISO CORRIDO
		UNIDADES	UNIDADES	UNIDADES
04.AC.848	Cremona 3 puntos	3	3	3
04.AC.055.M	Cerradero	9	9	9
04.AC.056	Embellecedor Cerradero	9	9	9
04.AC.843	Manilla Dcha.	2	2	2
04.AC.844	Manilla Izda.	1	1	1
04.AC.845	Tirador	1	1	1
04.AC.067	Kit Hoja Lateral	4	4	4
04.AC.068	Kit Hoja Central	8		
04.AC.069	Kit H.Central M.Inf. Oculto Tapas Aluminio		8	
04.AC.070	Kit H.Central M.Inf. Oculto Piso Corrido			8
04.AC.070	Tapa H.Lateral M.Inf. Oculto Tapas Aluminio		4	
04.AC.079	Tapa H.Lateral M.Inf. Oculto Piso Corrido			4
04.AC.071	Kit Cortavientos	4		
04.AC.080	Kit Cortavientos Marco Inferior Oculto		4	4
04.AC.076	Tope Inferior 4 Hojas M.Inf. Oculto		1	1
04.AC.075	Taco Estanq. M.Inf. Oculto Tapas Aluminio		2	
04.AC.081	Taco Estanq. M.Inf. Oculto Piso Corrido			2
04.ES.083	Escuadra Marco	12	12	12
04.AC.F10	Felpudo Marco	4L+4H	2L+4H	8L+4H
04.AC.F09	Felpudo Suplementos Hoja 16.349 y 16.651		2L	2L
04.JU.004.D	Junta Cierre Lateral	4H	4H	4H
04.JU.004.E	Junta Cierre 4 Hojas	2H	2H	2H
04.JU.062	Junta Cruce Central	8H	8H	8H
04.JU.067	Junta Cruce Central	8H	8H	8H
04.JU.068	Junta Tapa Canal Marco	6L	6L	6L
04.JU.069	Junta Carril	x6 L-200	L-200	L-200
04.AC.R150	Carril Acero Inox.	x6 L-200	L-200	L-200
04.AC.R151	Rodamiento	12	12	12
04.AC.R153	Kit Angulo Rod. M.Inf. Oculto Tapas Aluminio		6	
04.AC.R154	Kit Angulo Rod. M.Inf. Oculto Piso Corrido			6
04.TA.069	Juego Tapas Tirador	10	10	10
04.TA.070	Tapa para Canaleta	2	2	2
04.TA.072	Tapa para Solera	2	2	2
04.AC.073	Calzo Vidrio	Según dimensiones de Vidrio		

*Se indica la longitud total necesaria. Las tapas se colocan en tramos para permitir el montaje.

BALCONERA 4 HOJAS Marco 4 Carriles

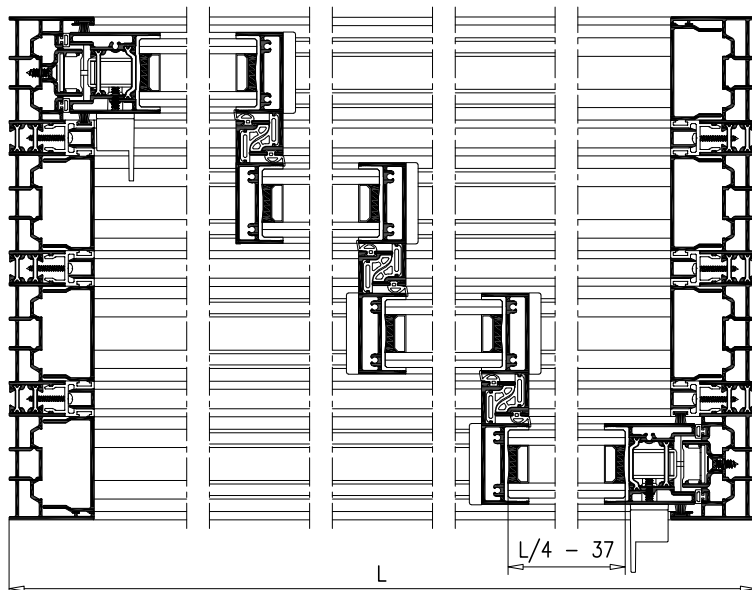
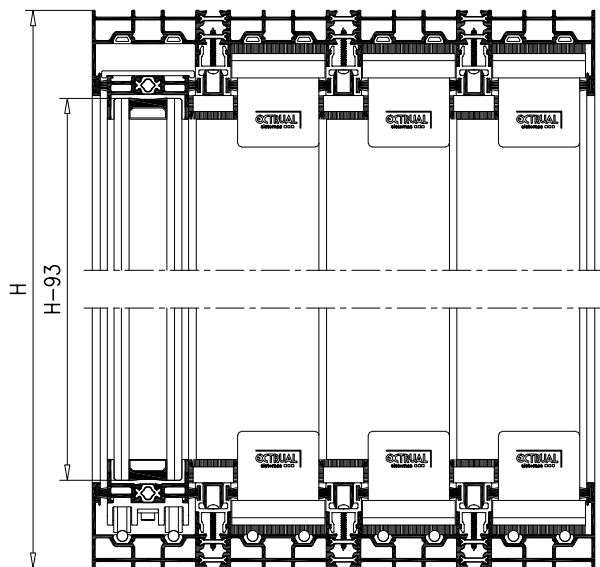

BALCONERA 4 HOJAS Marco 4 Carriles Marco Inferior Oculto Tapas de Aluminio

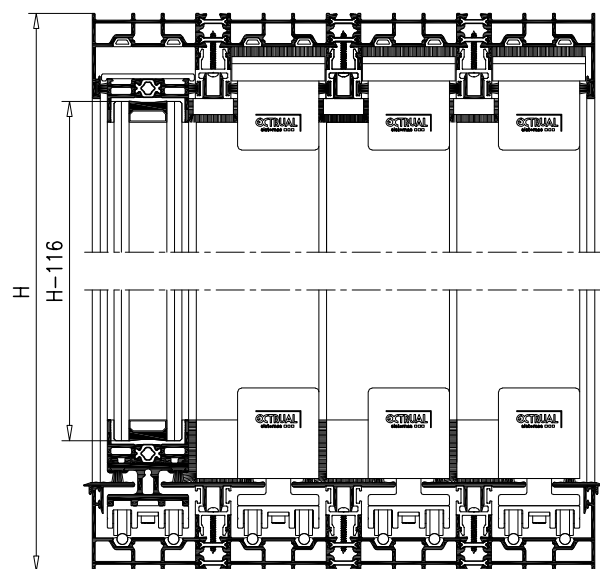



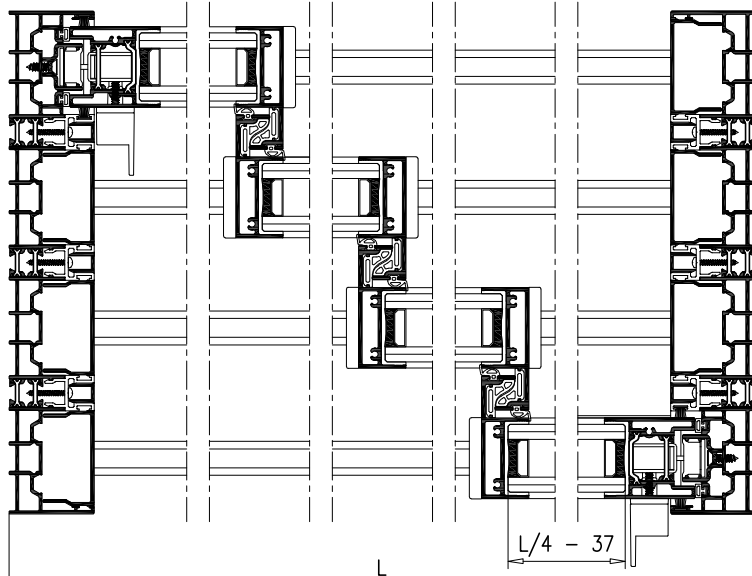
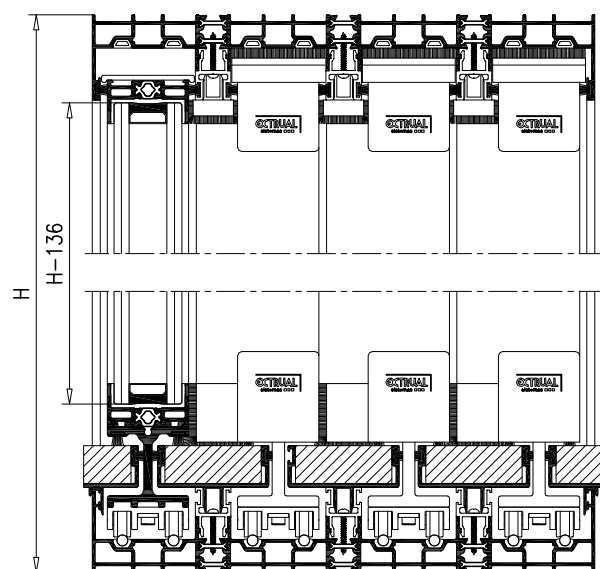



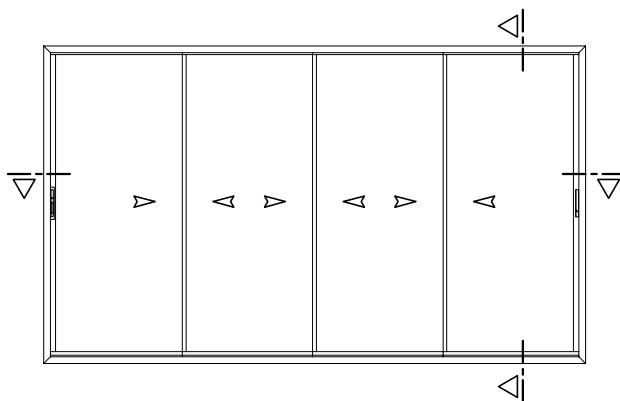



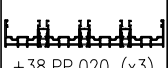

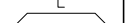
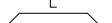
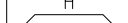
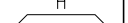
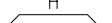

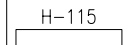
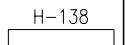
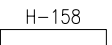

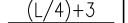
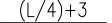
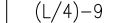
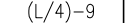
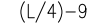

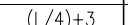
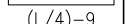

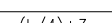
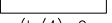

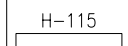
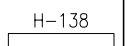
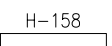

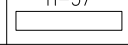
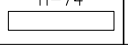
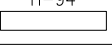

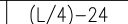
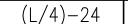
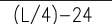
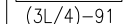
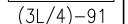
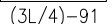
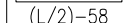
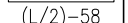
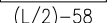
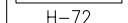
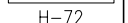
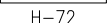

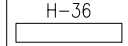
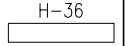
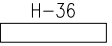

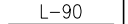





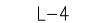
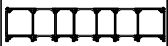
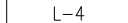
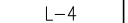
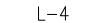

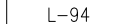
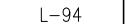
BALCONERA 4 HOJAS Marco 4 Carriles Marco Inferior Oculto Piso Corrido



BALCONERA 4 HOJAS Marco 4 Carriles

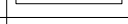
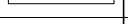
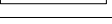

PERFILES

REFERENCIA	DENOMINACION	MARCO INFERIOR VISTO		MARCO INFERIOR OCULTO TAPAS ALUMINIO		MARCO INFERIOR OCULTO PISO CORRIDO	
		CANT.	CORTE	CANT.	CORTE	CANT.	CORTE
R-952	 +38.PP.020 (x3)	2		2		2	
		2		2		2	
R-943	 HOJA LATERAL	2		2		2	
R-945	 HOJA SUP/INF	4		4		4	
		4		4		4	
16.349	 SUPLEMENT. HOJA			2			
				2			
16.651	 SUPLEMENT. HOJA					2	
						2	
16.347	 HOJA DE CIERRE	6		6		6	
16.341	 CIERRE LATERAL	2		2		2	
16.342	 TAPA CANAL	4		2		2	
		4		2		2	
		4		2		2	
		6		6		6	
16.343	 TAPA MARCO	6		6		6	
16.344*	 TAPA CENTRAL			3			
16.345*	 TAPA LATERAL			2			
16.652*	 TAPA CENTRAL					3	
16.653*	 TAPA LATERAL					2	
R-953	 SOLERA	1		1		1	
15.686	 TAPA CANALETA	1		1			
16.351	 CANALETA DRENAJE	1		1		1	
16.348	 REFUERZO TIRADOR	6		6		6	
10.466	 TAPETA TIRADOR	6		6		6	

ACCESORIOS

REFERENCIA	DENOMINACION	M.INF. VISTO	M.INF. OCULTO TAPAS ALUMINIO	M.INF. OCULTO PISO CORRIDO
		UNIDADES	UNIDADES	UNIDADES
04.AC.848	Cremona 3 puntos	2	2	2
04.AC.055.M	Cerradero	6	6	6
04.AC.056	Embellecedor Cerradero	6	6	6
04.AC.843	Manilla Dcha.	1	1	1
04.AC.844	Manilla Izda.	1	1	1
04.AC.067	Kit Hoja Lateral	2	2	2
04.AC.068	Kit Hoja Central	6		
04.AC.069	Kit H.Central M.Inf. Oculto Tapas Aluminio		6	
04.AC.078	Kit H.Central M.Inf. Oculto Piso Corrido			6
04.AC.070	Tapa H.Lateral M.Inf. Oculto Tapas Aluminio		2	
04.AC.079	Tapa H.Lateral M.Inf. Oculto Piso Corrido			2
04.AC.071	Kit Cortavientos	3		
04.AC.080	Kit Cortavientos Marco Inferior Oculto		3	3
04.AC.075	Taco Estanq. M.Inf. Oculto Tapas Aluminio		2	
04.AC.081	Taco Estanq. M.Inf. Oculto Piso Corrido			2
04.ES.083	Escuadra Marco	16	16	16
04.AC.F10	Felpudo Marco	4L+4H	2L+4H	10L+4H
04.AC.F09	Felpudo Suplementos Hoja 16.349 y 16.651		2L	2L
04.JU.004.D	Junta Cierre Lateral	4H	4H	4H
04.JU.062	Junta Cruce Central	6H	6H	6H
04.JU.067	Junta Cruce Central	6H	6H	6H
04.JU.068	Junta Tapacanal Marco	8L	8L	8L
04.JU.069	Junta Carril	x8	L-200	L-200
04.AC.R150	Carril Acero Inox.	x8	L-200	L-200
04.AC.R151	Rodamiento	8	8	8
04.AC.R153	Kit Angulo Rod. M.Inf. Oculto Tapas Aluminio		4	
04.AC.R154	Kit Angulo Rod. M.Inf. Oculto Piso Corrido			4
04.TA.069	Juego Tapas Tirador	6	6	6
04.TA.070	Tapa para Canaleta	2	2	2
04.TA.075	Tapa para Solera	2	2	2
04.AC.073	Calzo Vidrio	Según dimensiones de Vidrio		

*Se indica la longitud total necesaria. Las tapas se colocan en tramos para permitir el montaje.

BALCONERA 8 HOJAS Marco 4 Carriles

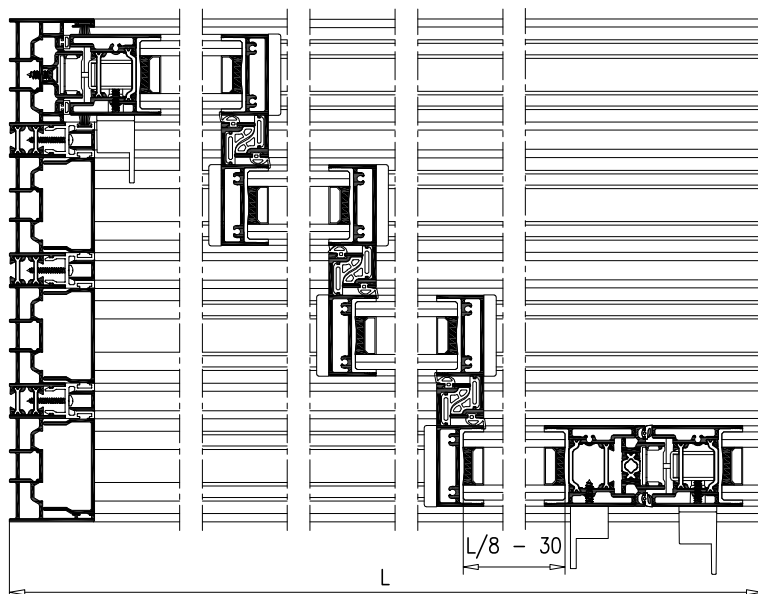
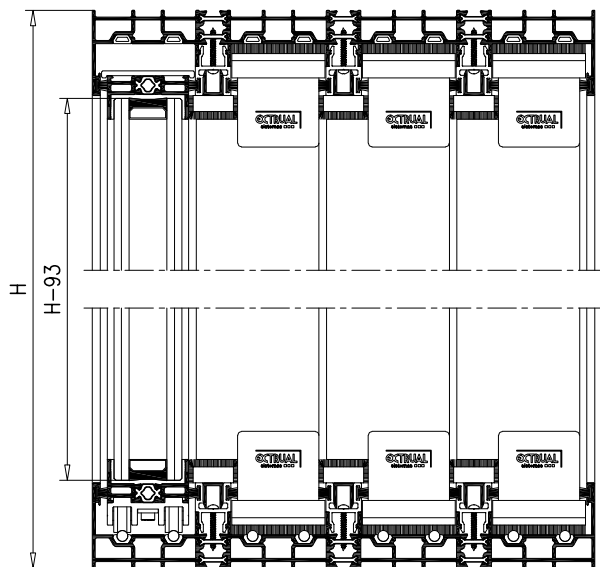

BALCONERA 4 HOJAS Marco 8 Carriles Marco Inferior Oculto Tapas de Aluminio

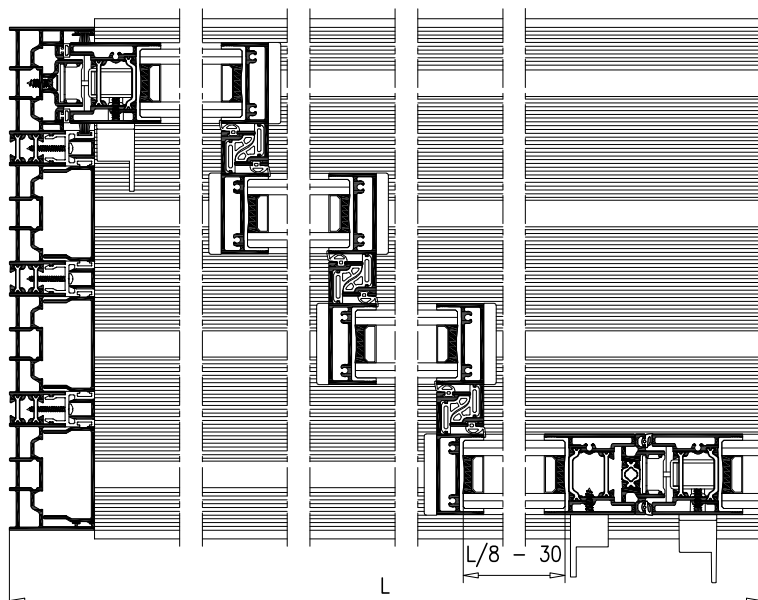
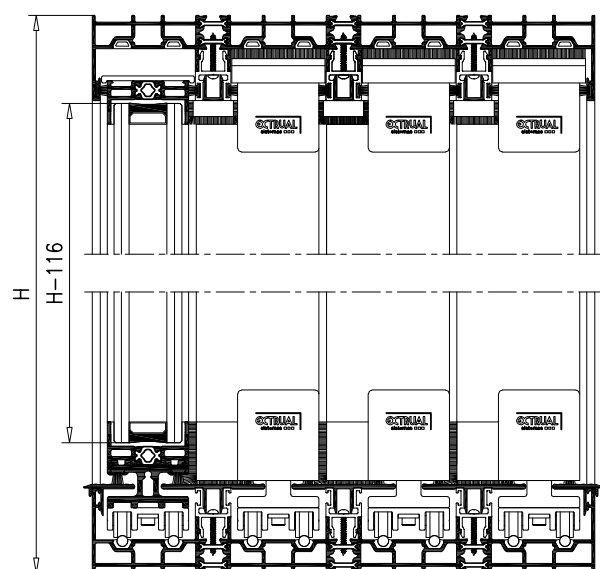



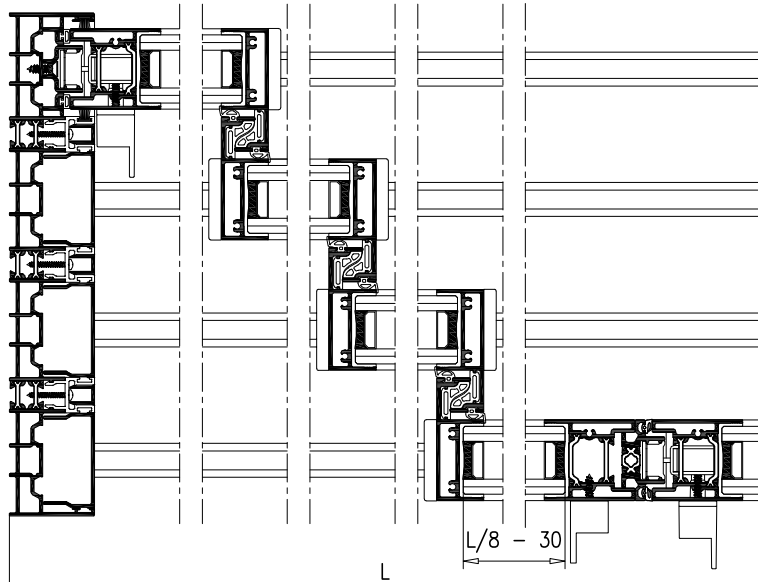
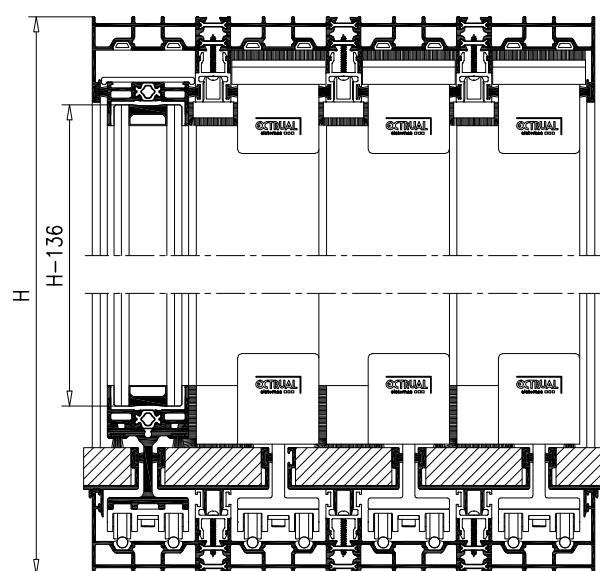





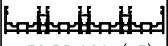







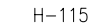
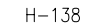

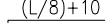
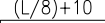
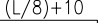
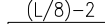
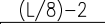
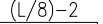

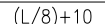
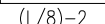

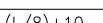
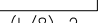

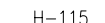
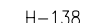

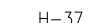
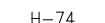
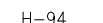

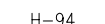
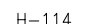

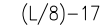
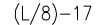
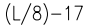
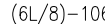
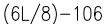
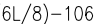
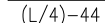
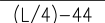
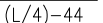
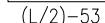
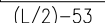
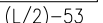
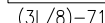
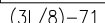
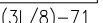
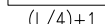
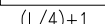
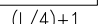
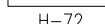
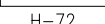
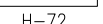

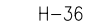
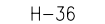
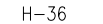

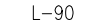

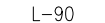

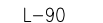

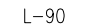

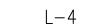
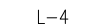
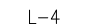
BALCONERA 4 HOJAS Marco 8 Carriles Marco Inferior Oculto Piso Corrido

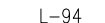
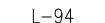

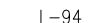
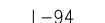
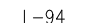
BALCONERA 8 HOJAS Marco 4 Carriles

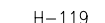
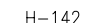
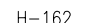
PERFILES

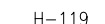
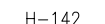
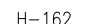
REFERENCIA	DENOMINACION	MARCO INFERIOR VISTO		MARCO INFERIOR OCULTO TAPAS ALUMINIO		MARCO INFERIOR OCULTO PISO CORRIDO	
		CANT.	CORTE	CANT.	CORTE	CANT.	CORTE
R-952	 MARCO +38.PP.020 (x3)	2		2		2	
		2		2		2	
R-943	 HOJA LATERAL	4		4		4	
R-945	 HOJA SUP/INF	8		8		8	
		8		8		8	
16.349	 SUPLEMENT. HOJA			4			
				4			
16.651	 SUPLEMENT. HOJA					4	
						4	
16.347	 HOJA DE CIERRE	12		12		12	
16.341	 CIERRE LATERAL	2		2		2	
R-946	 CIERRE 4 HOJAS	1		1		1	
16.342	 TAPA CANAL	4		2		2	
		2		1		1	
		4		2		2	
		2		1		1	
		4		2		2	
		2		1		1	
		6		6		6	
16.343	 TAPA MARCO	6		6		6	
16.344*	 TAPA CENTRAL			3			
16.345*	 TAPA LATERAL			2			
16.652*	 TAPA CENTRAL					3	
16.653*	 TAPA LATERAL					2	
R-949	 SOLERA	1		1		1	
15.686	 TAPA CANALETA	1		1			
16.351	 CANALETA DRENAJE	1		1		1	
16.348	 REFUERZO TIRADOR	12		12		12	
10.466	 TAPETA TIRADOR	12		12		12	

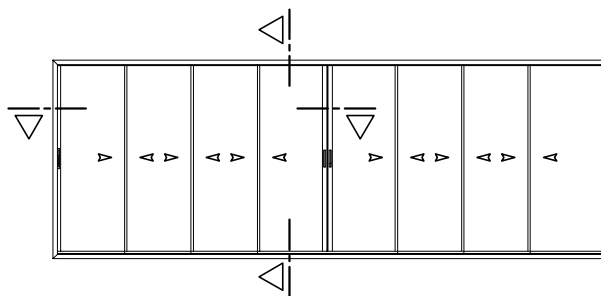

ACCESORIOS

REFERENCIA	DENOMINACION	M.INF. VISTO	M.INF. OCULTO TAPAS ALUMINIO	M.INF. OCULTO PISO CORRIDO
		UNIDADES	UNIDADES	UNIDADES
04.AC.848	Cremona 3 puntos	3	3	3
04.AC.055.M	Cerradero	9	9	9
04.AC.056	Embellecedor Cerradero	9	9	9
04.AC.843	Manilla Dcha.	2	2	2
04.AC.844	Manilla Izda.	1	1	1
04.AC.845	Tirador	1	1	1
04.AC.067	Kit Hoja Lateral	4	4	4
04.AC.068	Kit Hoja Central	12		
04.AC.069	Kit H.Central M.Inf. Oculto Tapas Aluminio		12	
04.AC.078	Kit H.Central M.Inf. Oculto Piso Corrido			12
04.AC.070	Tapa H.Lateral M.Inf. Oculto Tapas Aluminio		4	
04.AC.079	Tapa H.Lateral M.Inf. Oculto Piso Corrido			4
04.AC.071	Kit Cortavientos	6		
04.AC.080	Kit Cortavientos Marco Inferior Oculto		6	6
04.AC.076	Tope Inferior 4 Hojas M.Inf. Oculto		1	1
04.AC.075	Taco Estanq. M.Inf. Oculto Tapas Aluminio		2	
04.AC.081	Taco Estanq. M.Inf. Oculto Piso Corrido			2
04.ES.083	Escuadra Marco	16	16	16
04.AC.F10	Felpudo Marco	4L+4H	2L+4H	10L+4H
04.AC.F09	Felpudo Suplementos Hoja 16.349 y 16.651		2L	2L
04.JU.004.D	Junta Cierre Lateral	4H	4H	4H
04.JU.004.E	Junta Cierre 4 Hojas	2H	2H	2H
04.JU.062	Junta Cruce Central	12H	12H	12H
04.JU.067	Junta Cruce Central	12H	12H	12H
04.JU.068	Junta Tapa Canal Marco	8L	8L	8L
04.JU.069	Junta Carril	x8	L-200	L-200
04.AC.R150	Carril Acero Inox.	x8	L-200	L-200
04.AC.R151	Rodamiento	16	16	16
04.AC.R153	Kit Angulo Rod. M.Inf. Oculto Tapas Aluminio		8	
04.AC.R154	Kit Angulo Rod. M.Inf. Oculto Piso Corrido			8
04.TA.069	Juego Tapas Tirador	12	12	12
04.TA.070	Tapa para Canaleta	2	2	2
04.TA.075	Tapa para Solera	2	2	2
04.AC.073	Calzo Vidrio	Según dimensiones de Vidrio		

*Se indica la longitud total necesaria. Las tapas se colocan en tramos para permitir el montaje.

BALCONERA 1 HOJA ENTREMUROS

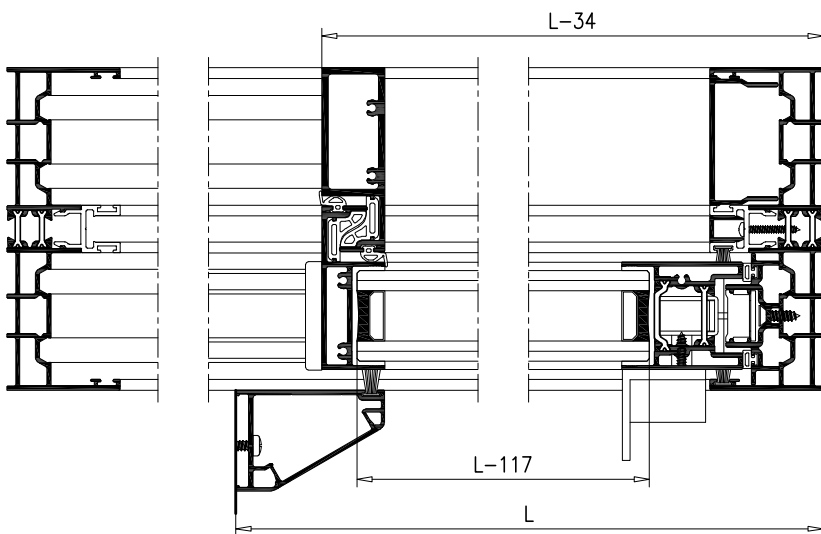
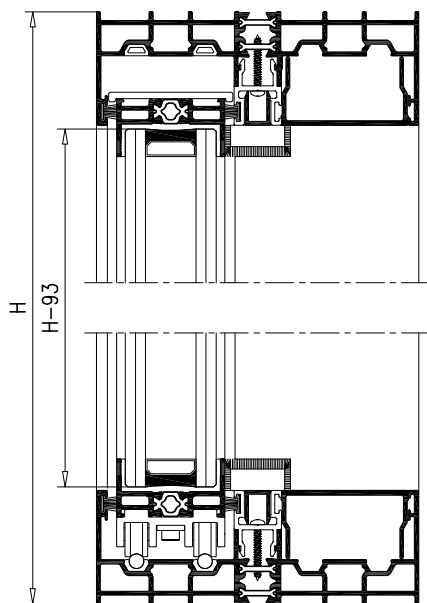

BALCONERA 1 HOJA ENTREMUROS
Marco Inferior Oculto Tapas de Aluminio

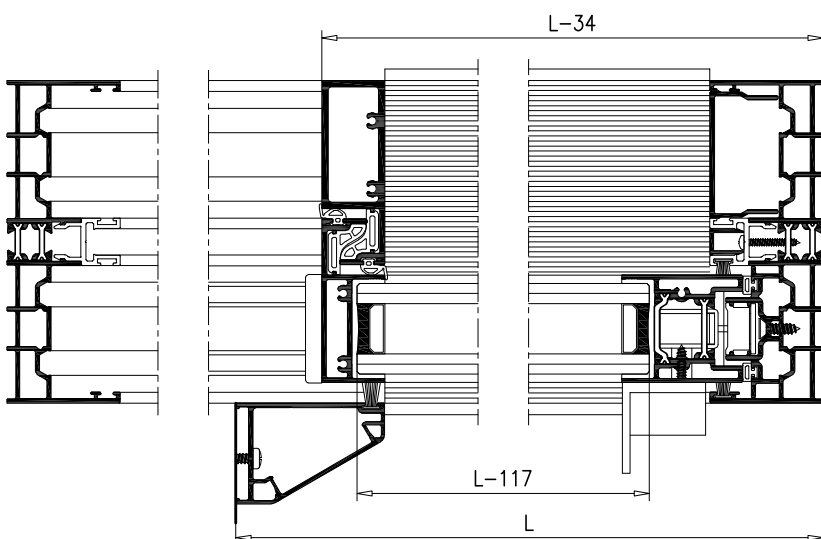
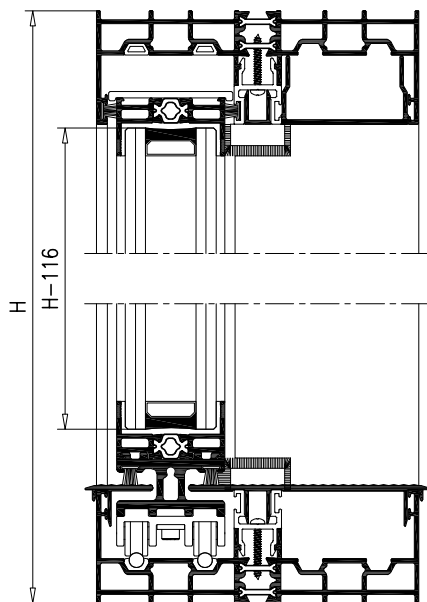

BALCONERA 1 HOJA ENTREMUROS
Marco Inferior Oculto Piso Corrido

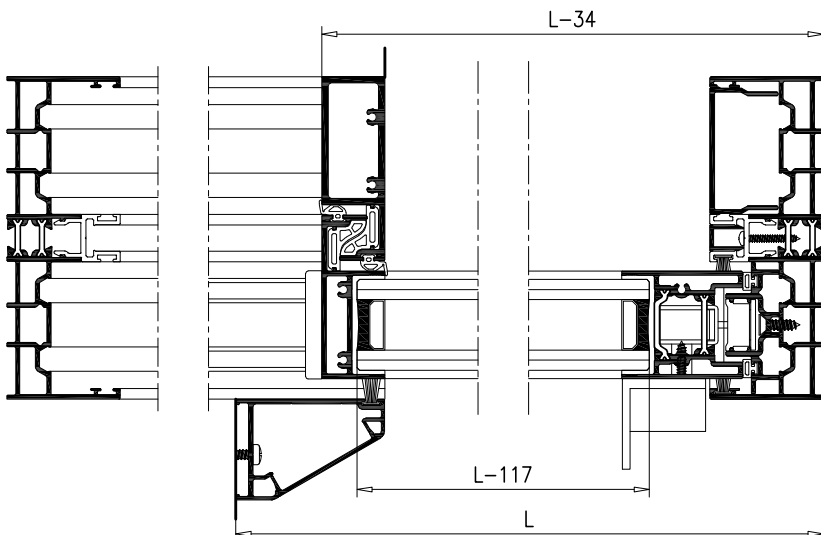
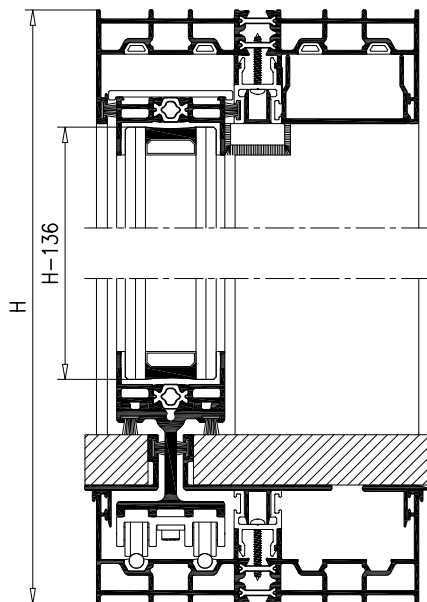

BALCONERA 1 HOJA ENTREMUROS

PERFILES

REFERENCIA	DENOMINACION	MARCO INFERIOR VISTO		MARCO INFERIOR OCULTO TAPAS ALUMINIO		MARCO INFERIOR OCULTO PISO CORRIDO	
		CANT.	CORTE	CANT.	CORTE	CANT.	CORTE
R-941	MARCO +38.PP.020	2	(2L)-130 H	2	(2L)-130 H	2	(2L)-130 H
16.350	PERFIL DE CIERRE	1	H-35	1	H-35	1	H-35
R-943	HOJA LATERAL	1	H-115	1	H-138	1	H-158
R-945	HOJA SUP/INF	2	L-77	2	L-77	2	L-77
16.349	SUPLEMENT. HOJA			1	L-77		
16.651	SUPLEMENT. HOJA					1	L-77
16.347	HOJA DE CIERRE	1	H-115	1	H-138	1	H-158
16.341	CIERRE LATERAL	1	H-37	1	H-74	1	H-94
13.248	CIERRE ENTREMUROS	1	H-90	1	H-90	1	H-112
7.438	TAPETA PARA 13.248	1	H-90	1	H-90	1	H-112
16.342	TAPA CANAL	2	L-104	1	L-104	1	L-104
		1	H-72	1	H-72	1	H-72
16.343	TAPA MARCO	2	L-104	1	L-104	1	L-104
		2	H-36	1	H-36	1	H-36
16.345*	TAPA LATERAL			1	L-104	1	L-104
16.346*	TAPA DOBLE			1	L-104		
16.653*	TAPA LATERAL					1	L-104
16.654*	TAPA MULTIPLE					1	L-104
R-948	SOLERA	1	(2L)-134	1	(2L)-134	1	(2L)-134
15.686	TAPA CANALETA	1	L-61	1	L-61		
16.351	CANALETA DRENAJE	1	L-61	1	L-61	1	L-61

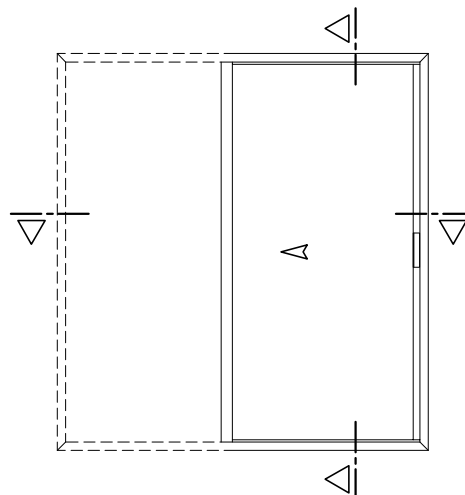

En caso de piso corrido las tapas que ocultan el marco inferior deben de ser registrables para permitir sacar las hojas en caso de necesidad.

ACCESORIOS

REFERENCIA	DENOMINACION	M.INF. VISTO	M.INF. OCULTO TAPAS ALUMINIO	M.INF. OCULTO PISO CORRIDO
		UNIDADES	UNIDADES	UNIDADES
04.AC.848	Cremona 3 puntos	1	1	1
04.AC.055.M	Cerradero	3	3	3
04.AC.056	Embellecedor Cerradero	3	3	3
04.AC.854	Manilla Izda.	1	1	1
04.AC.067	Kit Hoja Lateral	1	1	1
04.AC.068	Kit Hoja Central	1		
04.AC.069	Kit H.Central M.Inf. Oculto Tapas Aluminio		1	
04.AC.078	Kit H.Central M.Inf. Oculto Piso Corrido			1
04.AC.070	Tapa H.Lateral M.Inf. Oculto Tapas Aluminio		1	
04.AC.079	Tapa H.Lateral M.Inf. Oculto Piso Corrido			1
04.AC.071	Kit Cortavientos	1	1	1
04.AC.075	Taco Estanq. M.Inf. Oculto Tapas Aluminio		1	
04.AC.081	Taco Estanq. M.Inf. Oculto Piso Corrido			1
04.ES.083	Escuadra Marco	8	8	8
04.AC.F10	Felpudo Marco	4L+2H	2L+2H	4L+2H
04.AC.F09	Felpudo Suplementos Hoja 16.349 y 16.651		2L	2L
04.AC.F11	Felpudo Cierre Entremuros	H	H	H
04.JU.004.D	Junta Cierre Lateral	2H	2H	2H
04.JU.062	Junta Cruce Central	2H	2H	2H
04.JU.067	Junta Cruce Central	2H	2H	2H
04.JU.068	Junta Tapacanal Marco	2L	2L	2L
04.JU.069	Junta Carril	x2 (2L)-330	(2L)-330	(2L)-330
04.AC.R150	Carril Acero Inox.	x2 (2L)-330	(2L)-330	(2L)-330
04.AC.R151	Rodamiento	2	2	2
04.AC.R153	Kit Angulo Rod. M.Inf. Oculto Tapas Aluminio		1	
04.AC.R154	Kit Angulo Rod. M.Inf. Oculto Piso Corrido			1
04.TA.070	Tapa para Canaleta	2	2	2
04.TA.071	Tapa para Solera	2	2	2
04.AC.073	Calzo Vidrio	Según dimensiones de Vidrio		

*Se indica la longitud total necesaria. Las tapas se colocan en tramos para permitir el montaje.

En caso de piso corrido las tapas que ocultan el marco inferior deben de ser registrables para permitir sacar la hoja en caso de necesidad.

BALCONERA 2 HOJAS 1 Carril ENTREMUROS

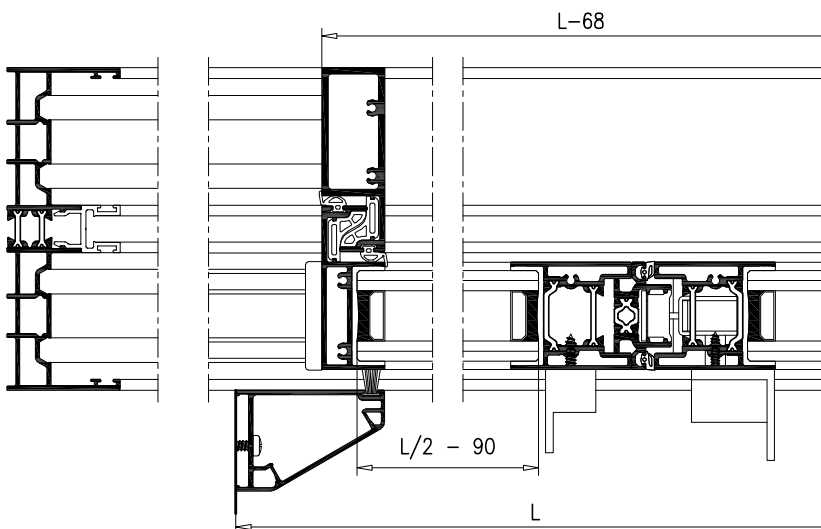
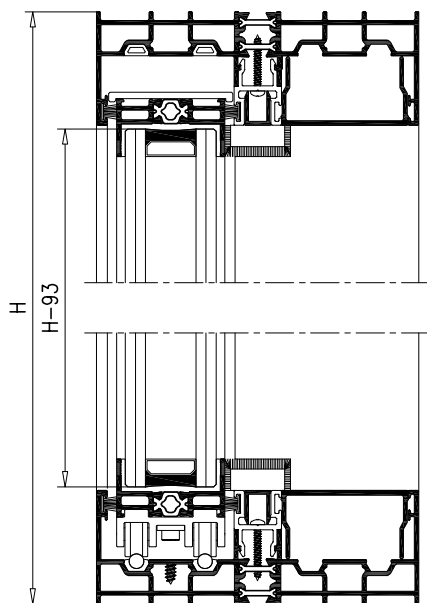

**BALCONERA 2 HOJAS 1 Carril ENTREMUROS
Marco Inferior Oculto Tapas de Aluminio**

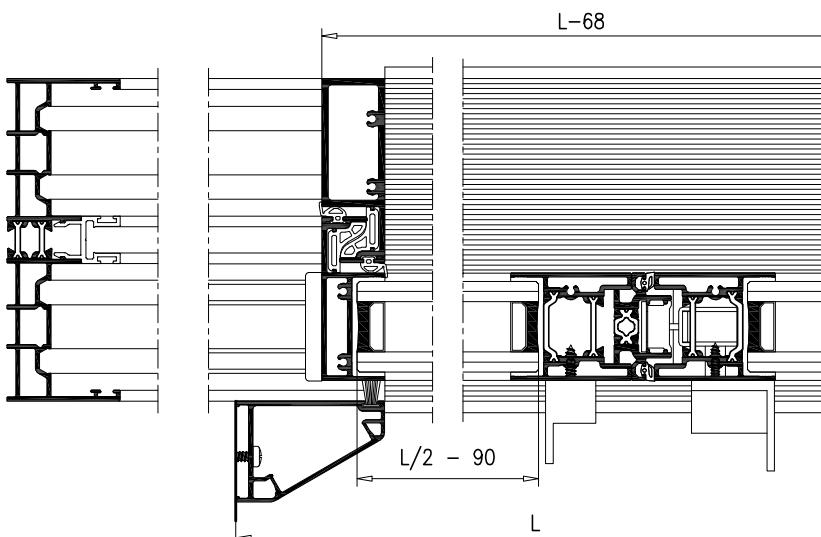
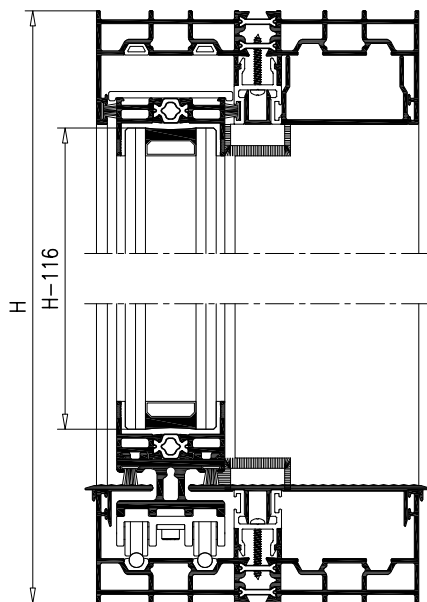

**BALCONERA 2 HOJAS 1 Carril ENTREMUROS
Marco Inferior Oculto Piso Corrido**

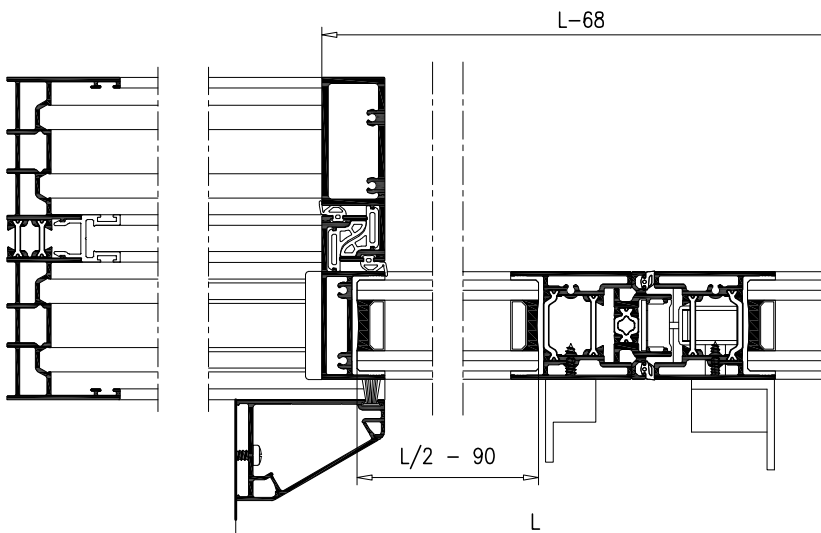
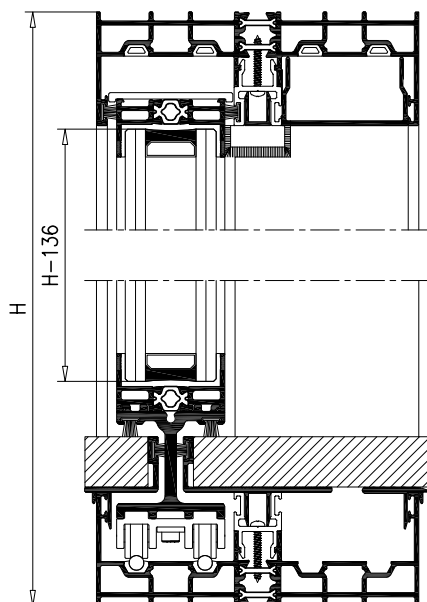

BALCONERA 2 HOJAS 1 Carril ENTREMUROS

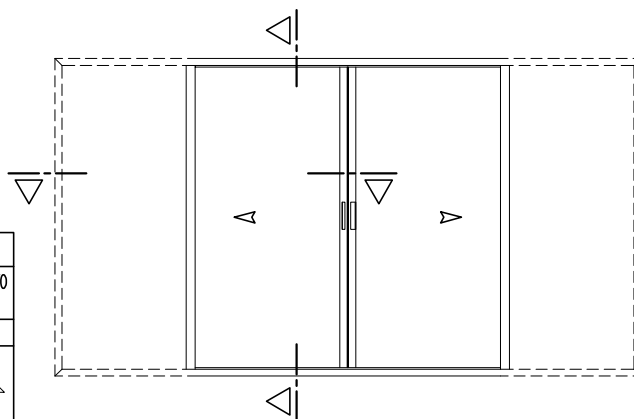

PERFILES

REFERENCIA	DENOMINACION	MARCO INFERIOR VISTO		MARCO INFERIOR OCULTO TAPAS ALUMINIO		MARCO INFERIOR OCULTO PISO CORRIDO	
		CANT.	CORTE	CANT.	CORTE	CANT.	CORTE
R-941	MARCO +38.PP.020	2	(2L)-205 H	2	(2L)-205 H	2	(2L)-205 H
16.350	PERFIL DE CIERRE	2	H-35	2	H-35	2	H-35
R-943	HOJA LATERAL	2	H-115	2	H-138	2	H-158
R-945	HOJA SUP/INF	4	(L/2)-50	4	(L/2)-50	4	(L/2)-50
16.349	SUPLEMENT. HOJA			2	(L/2)-50		
16.651	SUPLEMENT. HOJA					2	(L/2)-50
16.347	HOJA DE CIERRE	2	H-115	2	H-138	2	H-158
R-946	CIERRE 4 HOJAS	1	H-69	1	H-94	1	H-114
13.248	CIERRE ENTREMUROS	2	H-90	2	H-90	2	H-112
7.438	TAPETA PARA 13.248	2	H-90	2	H-90	2	H-112
16.342	TAPA CANAL	2	L-118	1	L-118	1	L-118
16.343	TAPA MARCO	2	L-118	1	L-118	1	L-118
16.345*	TAPA LATERAL			1	L-118	1	L-118
16.346*	TAPA DOBLE			1	L-118		
16.653*	TAPA LATERAL					1	L-118
16.654*	TAPA MULTIPLE					1	L-118
R-948	SOLERA	1	(2L)-209	1	(2L)-209	1	(2L)-209
15.686	TAPA CANALETA	1	L-122	1	L-122		
16.351	CANALETA DRENAJE	1	L-122	1	L-122	1	L-122

ACCESORIOS

REFERENCIA	DENOMINACION	M.INF. VISTO	M.INF. OCULTO TAPAS ALUMINIO	M.INF. OCULTO PISO CORRIDO
		UNIDADES	UNIDADES	UNIDADES
04.AC.848	Cremona 3 puntos	1	1	1
04.AC.055.M	Cerradero	3	3	3
04.AC.056	Embellecedor Cerradero	3	3	3
04.AC.853	Manilla Dcha.	1	1	1
04.AC.845	Tirador	1	1	1
04.AC.067	Kit Hoja Lateral	2	2	2
04.AC.068	Kit Hoja Central	2		
04.AC.069	Kit H.Central M.Inf. Oculto Tapas Aluminio		2	
04.AC.078	Kit H.Central M.Inf. Oculto Piso Corrido			2
04.AC.070	Tapa H.Lateral M.Inf. Oculto Tapas Aluminio		2	
04.AC.079	Tapa H.Lateral M.Inf. Oculto Piso Corrido			2
04.AC.071	Kit Cortavientos	1	1	1
04.AC.076	Tope Inferior 4 Hojas M.Inf. Oculto		1	1
04.ES.083	Escuadra Marco	8	8	8
04.AC.F10	Felpudo Marco	4L	2L	4L
04.AC.F09	Felpudo Suplementos Hoja 16.349 y 16.651		2L	2L
04.AC.F11	Felpudo Cierre Entremuros	2H	2H	2H
04.JU.004.E	Junta Cierre 4 Hojas	2H	2H	2H
04.JU.062	Junta Cruce Central	4H	4H	4H
04.JU.067	Junta Cruce Central	4H	4H	4H
04.JU.068	Junta Tapacanal Marco	2L	2L	2L
04.JU.069	Junta Carril	x2	(2L)-400	(2L)-400
04.AC.R150	Carril Acero Inox.	x2	(2L)-400	(2L)-400
04.AC.R151	Rodamiento	4	4	4
04.AC.R153	Kit Angulo Rod. M.Inf. Oculto Tapas Aluminio		2	
04.AC.R154	Kit Angulo Rod. M.Inf. Oculto Piso Corrido			2
04.TA.070	Tapa para Canaleta	2	2	2
04.TA.071	Tapa para Solera	2	2	2
04.AC.073	Calzo Vidrio	Según dimensiones de Vidrio		

*Se indica la longitud total necesaria. Las tapas se colocan en tramos para permitir el montaje.

En caso de piso corrido las tapas que ocultan el marco inferior deben de ser registrables para permitir sacar la hoja en caso de necesidad.

BALCONERA 2 HOJAS ENTREMUROS

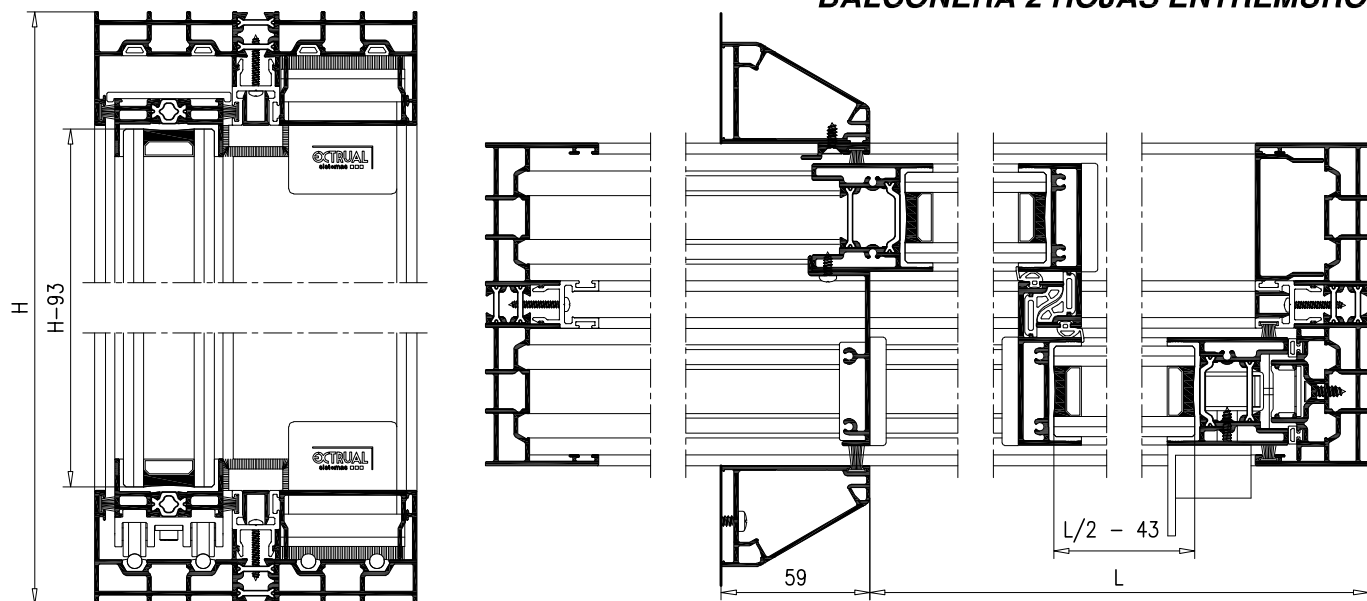

BALCONERA 2 HOJAS ENTREMUROS Marco Inferior Oculto Tapas de Aluminio

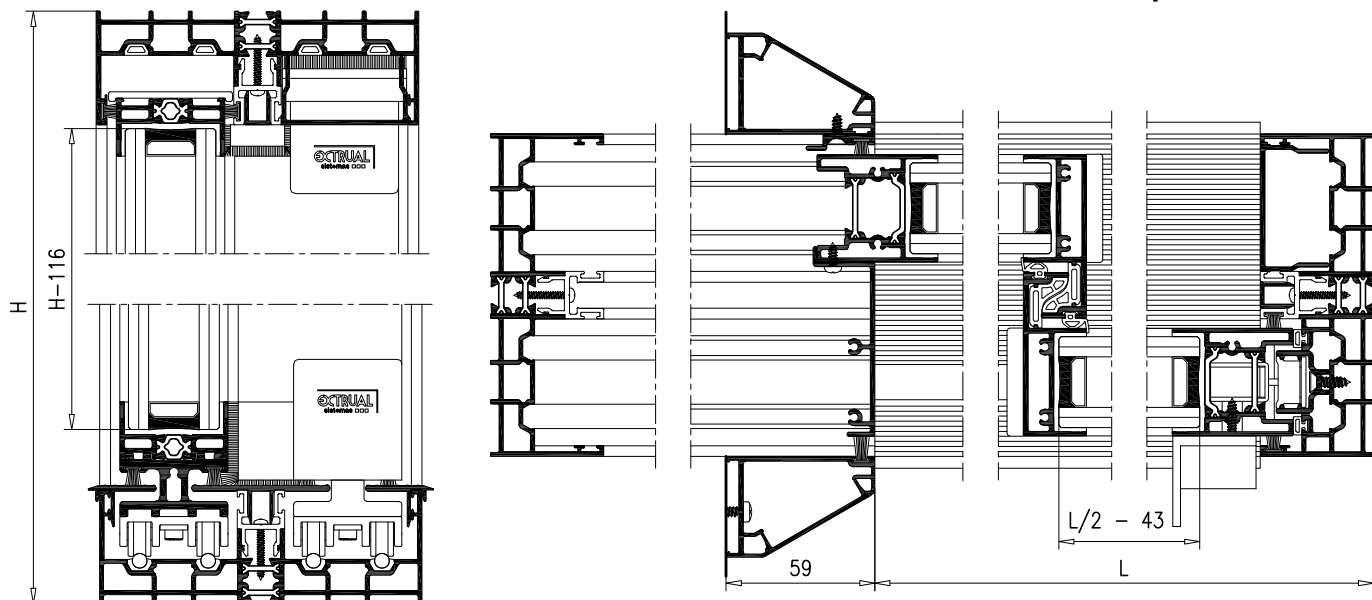

BALCONERA 2 HOJAS ENTREMUROS Marco Inferior Oculto Piso Corrido

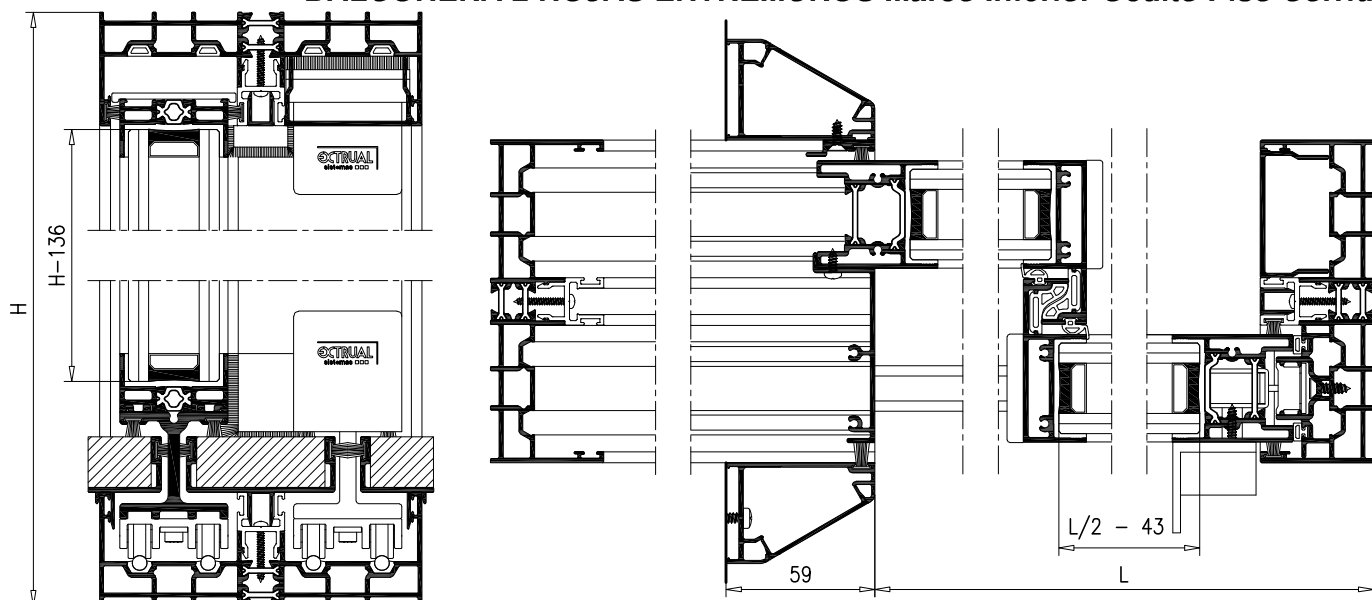

BALCONERA 2 HOJAS ENTREMUROS

PERFILES

REFERENCIA	DENOMINACION	MARCO INFERIOR VISTO		MARCO INFERIOR OCULTO TAPAS ALUMINIO		MARCO INFERIOR OCULTO PISO CORRIDO	
		CANT.	CORTE	CANT.	CORTE	CANT.	CORTE
R-941	MARCO +38.PP.020	2		2		2	
R-943	HOJA LATERAL	2		2		2	
R-945	HOJA SUP/INF	4		4		4	
16.349	SUPLEMENT. HOJA			2			
16.651	SUPLEMENT. HOJA					4	
16.347	HOJA DE CIERRE	2		2		2	
16.341	CIERRE LATERAL	1		1		1	
16.657	CRUCE ENTREMUROS	1		1		1	
16.658	TAPA LAT. ENTREMUROS	1		1		1	
13.248	CIERRE ENTREMUROS	2		2		2	
7.438	TAPETA PARA 13.248	2		2		2	
16.342	TAPA CANAL	2		1		1	
		2		1		1	
		1		1		1	
16.343	TAPA MARCO	2		1		1	
		2		1		1	
16.344*	TAPA CENTRAL			1			
16.345*	TAPA LATERAL			1		1	
				1			
16.346*	TAPA DOBLE			1			
16.652*	TAPA CENTRAL					1	
16.653*	TAPA LATERAL					1	
						1	
16.654*	TAPA MULTIPLE					1	
R-948	SOLERA	1		1		1	
15.686	TAPA CANALETA	1		1			
16.351	CANALETA DRENAJE	1		1		1	

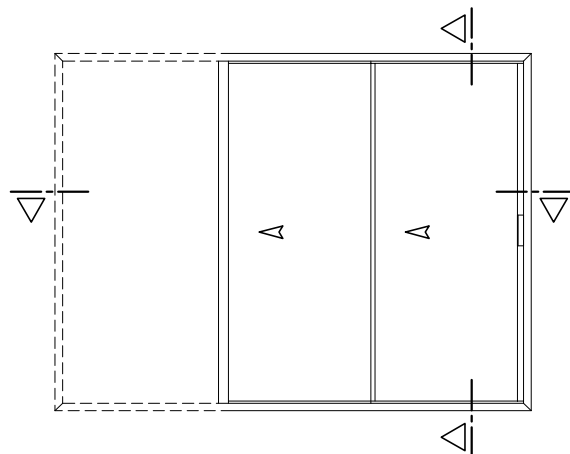

En caso de piso corrido las tapas que ocultan el marco inferior deben de ser registrables para permitir sacar las hojas en caso de necesidad.

ACCESORIOS

REFERENCIA	DENOMINACION	M.INF. VISTO	M.INF. OCULTO TAPAS ALUMINIO	M.INF. OCULTO PISO CORRIDO
		UNIDADES	UNIDADES	UNIDADES
04.AC.848	Cremona 3 puntos	1	1	1
04.AC.055.M	Cerradero	3	3	3
04.AC.056	Embellecedor Cerradero	3	3	3
04.AC.854	Manilla Izda.	1	1	1
04.AC.067	Kit Hoja Lateral	2	2	2
04.AC.068	Kit Hoja Central	3		
04.AC.069	Kit H.Central M.Inf. Oculto Tapas Aluminio		3	
04.AC.078	Kit H.Central M.Inf. Oculto Piso Corrido			3
04.AC.070	Tapa H.Lateral M.Inf. Oculto Tapas Aluminio		2	
04.AC.079	Tapa H.Lateral M.Inf. Oculto Piso Corrido			2
04.AC.071	Kit Cortavientos Entremuros	2		
04.AC.080	Kit Cortavientos M.Inf. Oculto		2	2
04.AC.075	Taco Estanq. M.Inf. Oculto Tapas Aluminio		1	
04.AC.081	Taco Estanq. M.Inf. Oculto Piso Corrido			1
04.ES.083	Escuadra Marco	8	8	8
04.AC.F10	Felpudo Marco	4L+3H	2L+3H	4L+3H
04.AC.F09	Felpudo Suplementos Hoja 16.349 y 16.651		2L	2L
04.AC.F11	Felpudo Cierre Entremuros	H	H	H
04.JU.004.D	Junta Cierre Lateral	2H	2H	2H
04.JU.062	Junta Cruce Central	2H	2H	2H
04.JU.067	Junta Cruce Central	2H	2H	2H
04.JU.068	Junta Tapa canal Marco	3L	3L	3L
04.JU.069	Junta Carril	x4	3(L/2)-230	3(L/2)-230
04.AC.R150	Carril Acero Inox.	x4	3(L/2)-230	3(L/2)-230
04.AC.R151	Rodamiento	4	4	4
04.AC.R153	Kit Angulo Rod. M.Inf. Oculto Tapas Aluminio		2	
04.AC.R154	Kit Angulo Rod. M.Inf. Oculto Piso Corrido			2
04.TA.070	Tapa para Canaleta	2	2	2
04.TA.071	Tapa para Solera	2	2	2
04.AC.073	Calzo Vidrio	Según dimensiones de Vidrio		

*Se indica la longitud total necesaria. Las tapas se colocan en tramos para permitir el montaje.

El perfil 16.651 se coloca deslizado en la hoja inferior en 2 trozos, para permitir sascar la hoja del marco en caso de necesidad una vez colocado el piso.

BALCONERA 4 HOJAS ENTREMUROS Marco 2 Carriles

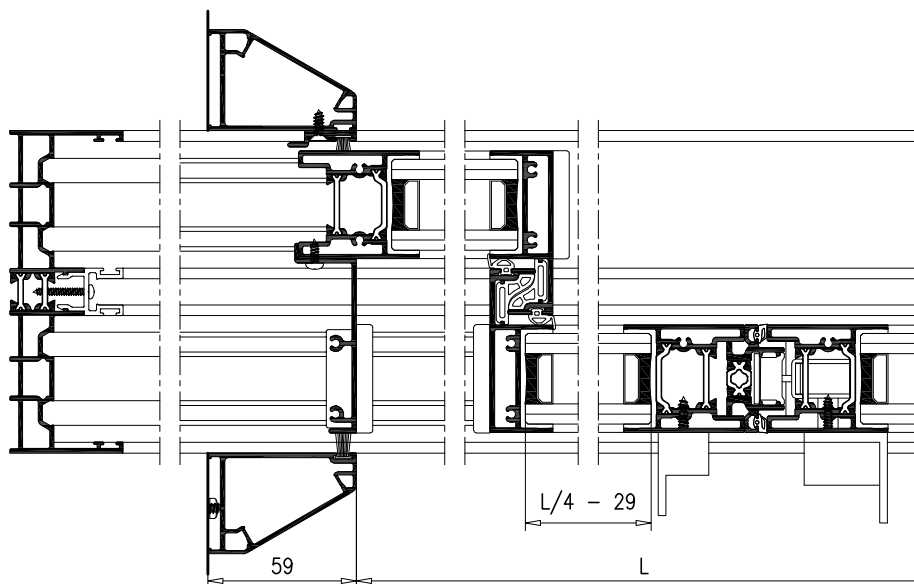
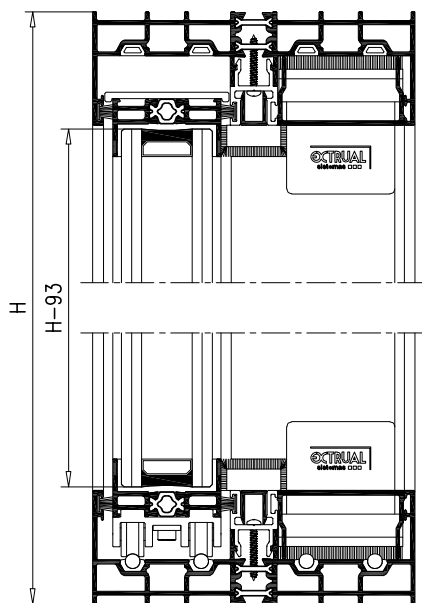

BALCONERA 4 HOJAS ENTREMUROS Marco Inferior Oculto Tapas de Aluminio Marco 2 Carriles

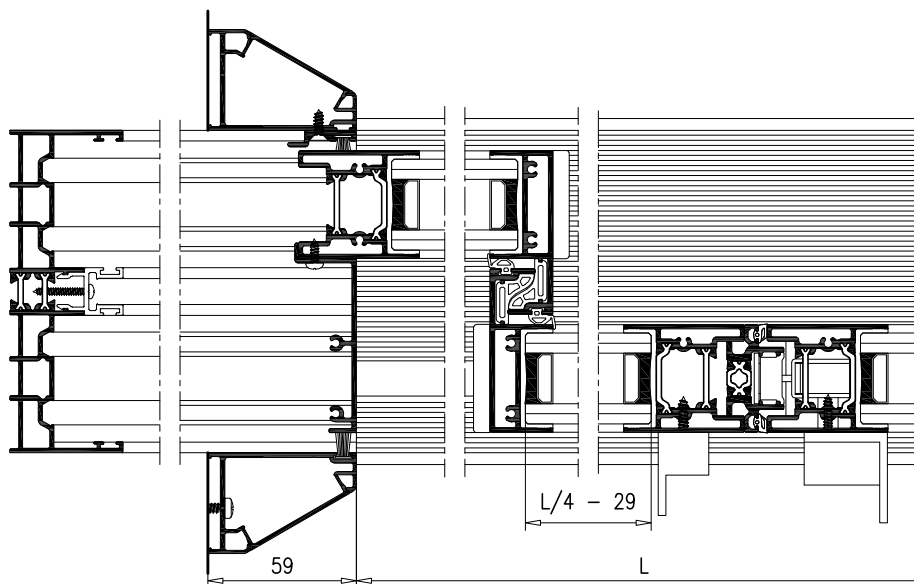
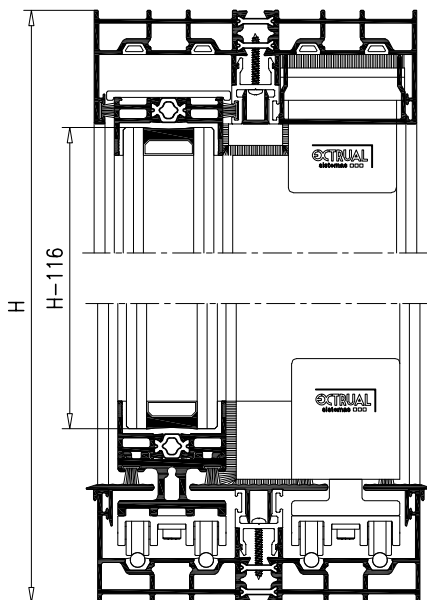

BALCONERA 4 HOJAS ENTREMUROS Marco Inferior Oculto Piso Corrido Marco 2 Carriles

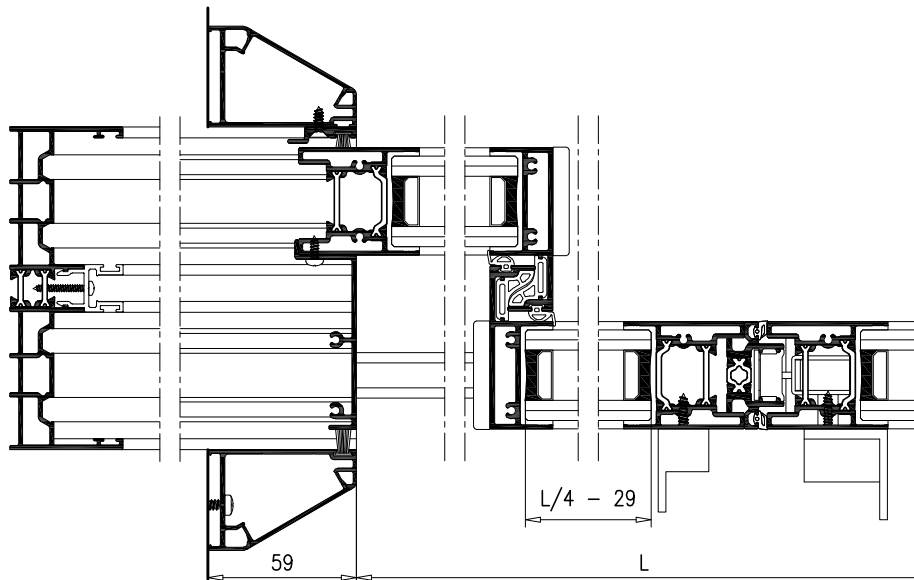
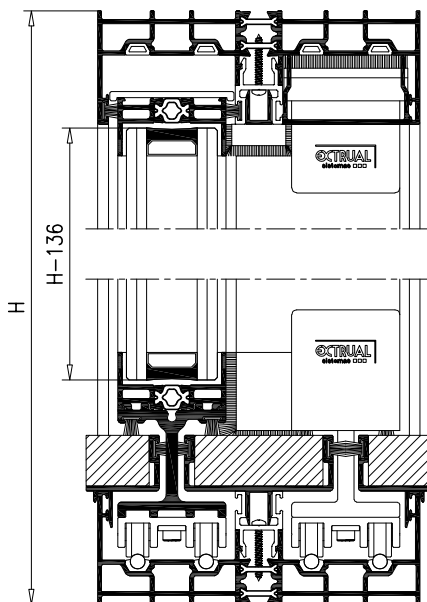

BALCONERA 4 HOJAS ENTREMUROS Marco 2 Carriles

PERFILES

REFERENCIA	DENOMINACION	MARCO INFERIOR VISTO		MARCO INFERIOR OCULTO TAPAS ALUMINIO		MARCO INFERIOR OCULTO PISO CORRIDO	
		CANT.	CORTE	CANT.	CORTE	CANT.	CORTE
R-941	MARCO +38.PP.020	2	$3(L/2)+95$	2	$3(L/2)+95$	2	$3(L/2)+95$
		2	H	2	H	2	H
R-943	HOJA LATERAL	4	H-115	4	H-138	4	H-158
R-945	HOJA SUP/INF	8	$(L/4)+11$	8	$(L/4)+11$	8	$(L/4)+11$
16.349	SUPLEMENT. HOJA			4	$(L/4)+11$		
16.651	SUPLEMENT. HOJA					4	$(L/4)+11$
16.347	HOJA DE CIERRE	4	H-115	4	H-138	4	H-158
R-946	CIERRE 4 HOJAS	1	H-69	1	H-94	1	H-114
16.657	CRUCE ENTREMUROS	2	H-90	2	H-90	2	H-90
16.658	TAPA LAT. ENTREMUROS	2	H-115	2	H-106	2	H-126
13.248	CIERRE ENTREMUROS	4	H-90	4	H-90	4	H-112
7.438	TAPETA PARA 13.248	4	H-90	4	H-90	4	H-112
16.342	TAPA CANAL	2	$(L/2)+2$	1	$(L/2)+2$	1	$(L/2)+2$
		4	$(L/4)-26$	2	$(L/4)-26$	2	$(L/4)-26$
16.343	TAPA MARCO	2	$(L/2)+2$	1	$(L/2)+2$	1	$(L/2)+2$
16.344*	TAPA CENTRAL			2	$(L/4)+8$		
16.345*	TAPA LATERAL			2	$(L/4)+3$	1	$(L/2)-6$
				1	L+10		
16.346*	TAPA DOBLE			1	$(L/2)-6$		
16.652*	TAPA CENTRAL					1	$(L/4)+8$
16.653*	TAPA LATERAL					1	$(L/4)+3$
						1	L
16.654*	TAPA MULTIPLE					1	$(L/2)-6$
R-948	SOLERA	1	$3(L/2)+91$	1	$3(L/2)+91$	1	$3(L/2)+91$
15.686	TAPA CANALETA	1	L-4	1	L-4		
16.351	CANALETA DRENAJE	1	L-4	1	L-4	1	L-4

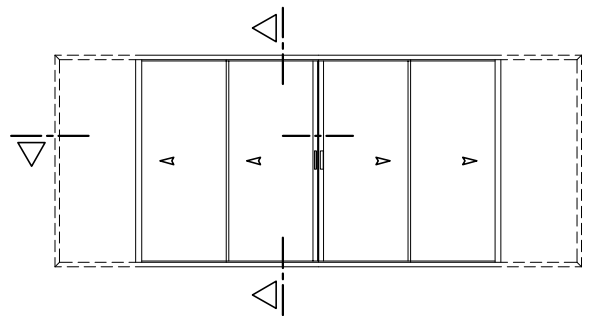

ACCESORIOS

REFERENCIA	DENOMINACION	M.INF. VISTO	M.INF. OCULTO TAPAS ALUMINIO	M.INF. OCULTO PISO CORRIDO
		UNIDADES	UNIDADES	UNIDADES
04.AC.848	Cremona 3 puntos	1	1	1
04.AC.055.M	Cerradero	3	3	3
04.AC.056	Embellecedor Cerradero	3	3	3
04.AC.853	Manilla Dcha.	1	1	1
04.AC.845	Tirador	1	1	1
04.AC.067	Kit Hoja Lateral	4	4	4
04.AC.068	Kit Hoja Central	6		
04.AC.069	Kit H.Central M.Inf. Oculto Tapas Aluminio		6	
04.AC.078	Kit H.Central M.Inf. Oculto Piso Corrido			6
04.AC.070	Tapa H.Lateral M.Inf. Oculto Tapas Aluminio		4	
04.AC.079	Tapa H.Lateral M.Inf. Oculto Piso Corrido			4
04.AC.071	Kit Cortavientos	4		
04.AC.080	Kit Cortavientos M.Inf. Oculto		4	4
04.AC.076	Tope Inferior 4 Hojas M.Inf. Oculto		1	1
04.ES.083	Escuadra Marco	8	8	8
04.AC.F10	Felpudo Marco	4L+2H	2L+2H	6L+2H
04.AC.F09	Felpudo Suplementos Hoja 16.349 y 16.651		2L	2L
04.AC.F11	Felpudo Cierre Entremuros	2H	2H	2H
04.JU.004.E	Junta Cierre 4 Hojas	2H	2H	2H
04.JU.062	Junta Cruce Central	4H	4H	4H
04.JU.067	Junta Cruce Central	4H	4H	4H
04.JU.068	Junta Tapacanal Marco	4L	4L	4L
04.JU.069	Junta Carril	x4	$3(L/2)-230$	$3(L/2)-230$
04.AC.R150	Carril Acero Inox.	x4	$3(L/2)-230$	$3(L/2)-230$
04.AC.R151	Rodamiento	8	8	8
04.AC.R153	Kit Angulo Rod. M.Inf. Oculto Tapas Aluminio		4	
04.AC.R154	Kit Angulo Rod. M.Inf. Oculto Piso Corrido			4
04.TA.070	Tapa para Canaleta	2	2	2
04.TA.071	Tapa para Solera	2	2	2
04.AC.073	Calzo Vidrio	Según dimensiones de Vidrio		

*Se indica la longitud total necesaria. Las tapas se colocan en tramos para permitir el montaje.

En caso de piso corrido las tapas que ocultan el marco inferior deben de ser registrables para permitir sacar la hoja en caso de necesidad.

BALCONERA 3 HOJAS ENTREMUROS Marco 3 Carriles

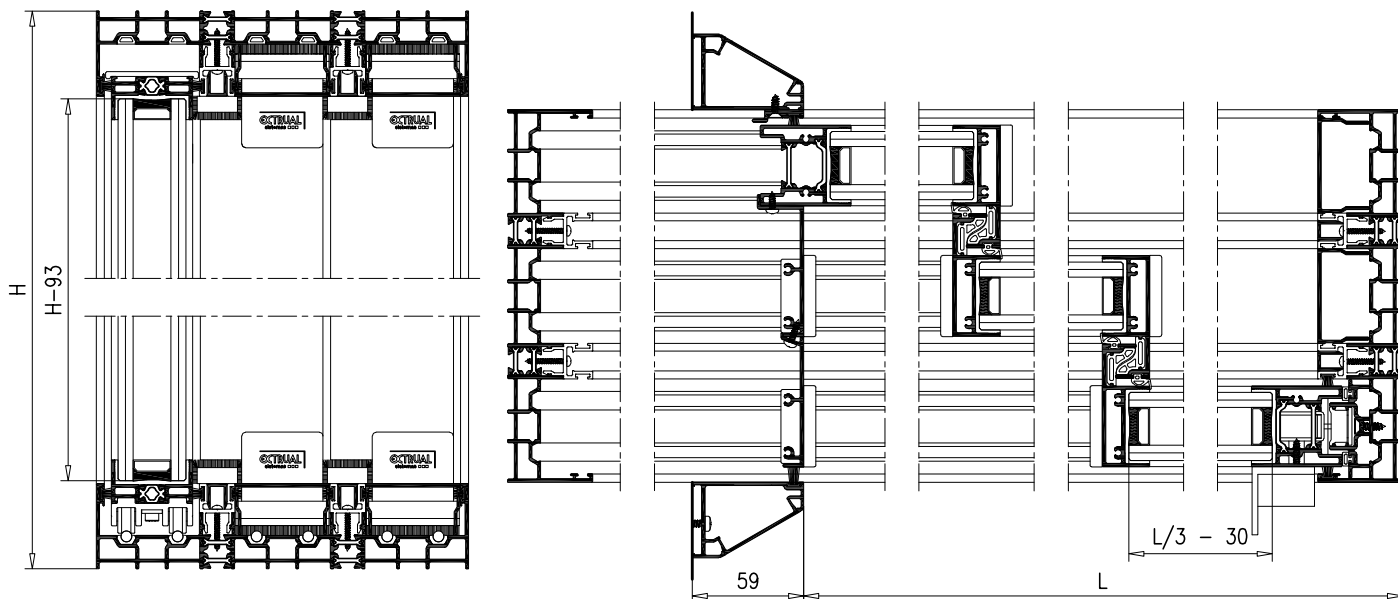



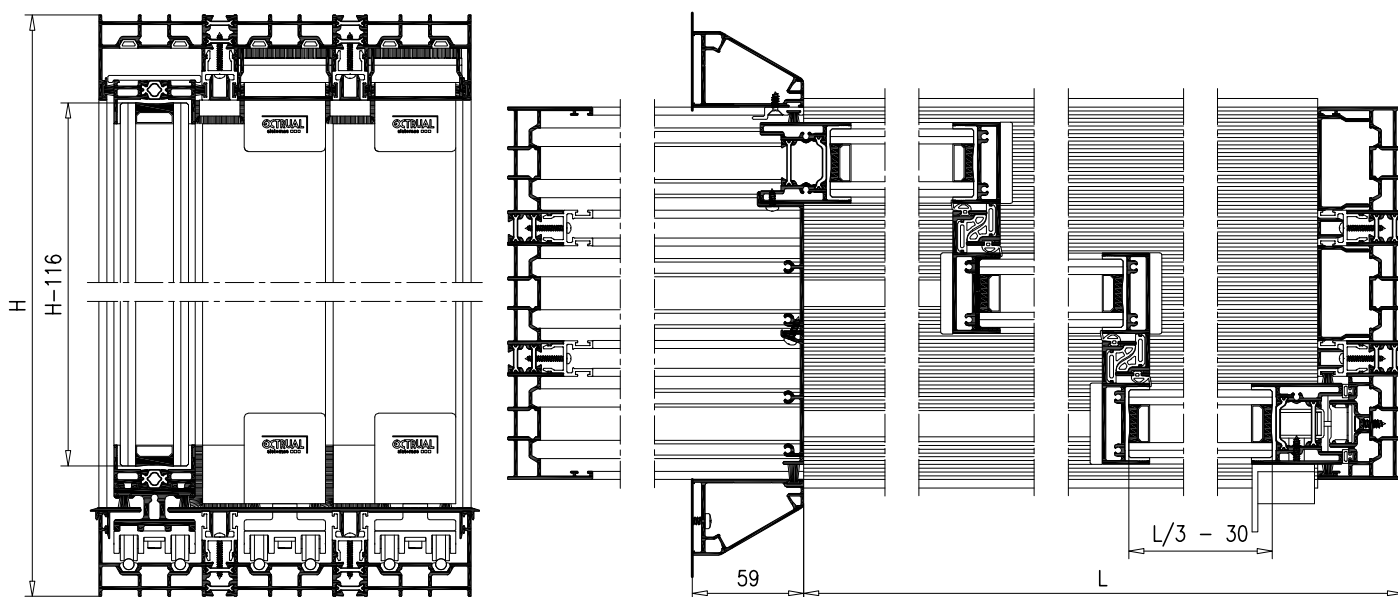



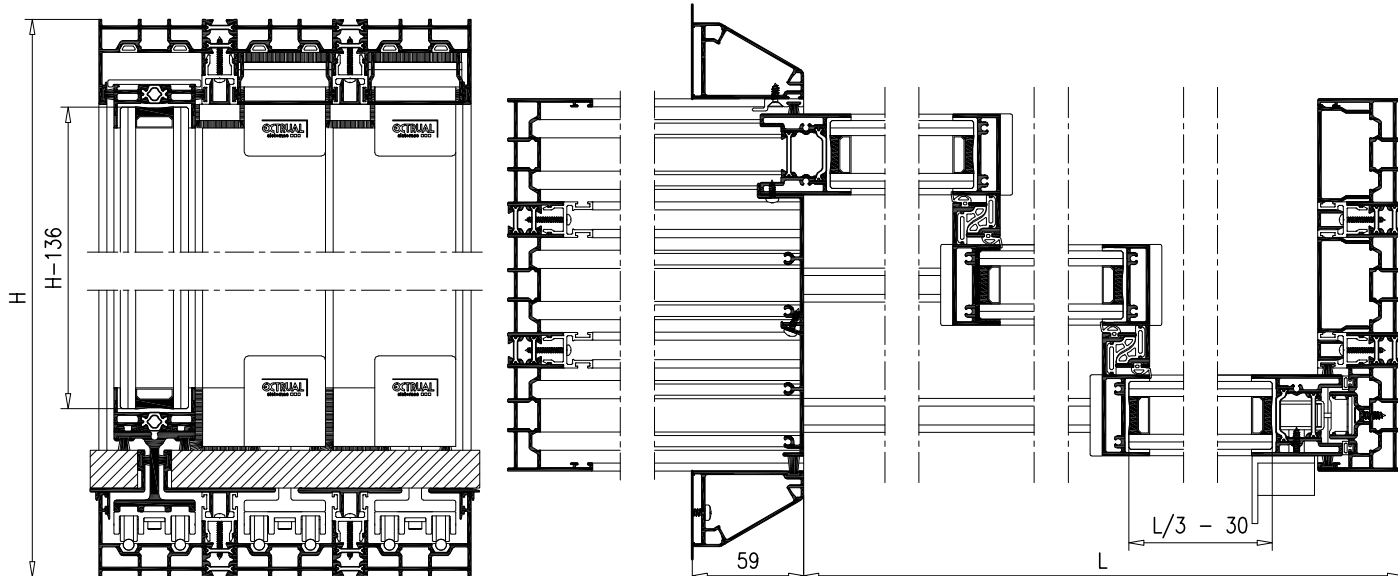



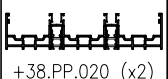
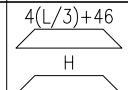
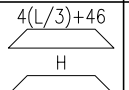
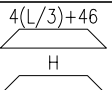

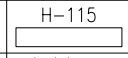
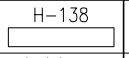
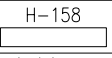

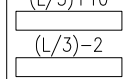
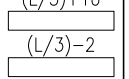
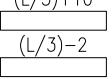

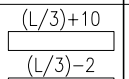

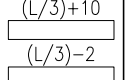

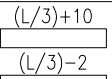
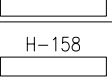

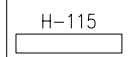
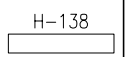
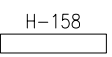

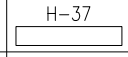
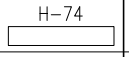
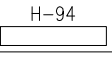

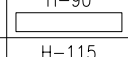
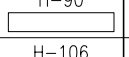
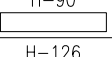

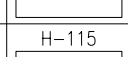
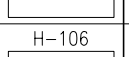
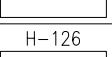

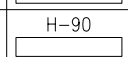
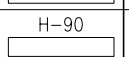
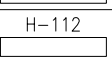

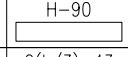
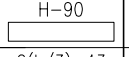
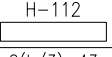

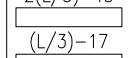
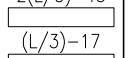
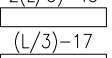

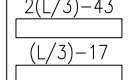
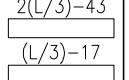
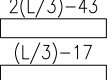
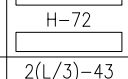
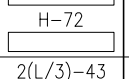
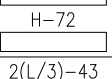
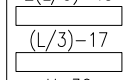
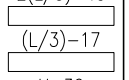
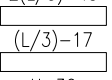

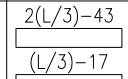
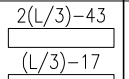
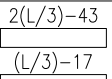
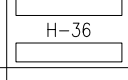
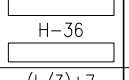
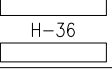

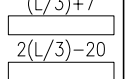

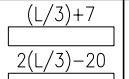
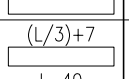

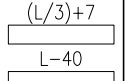
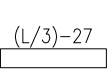
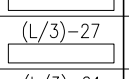

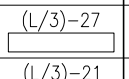
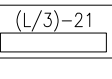

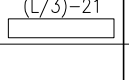
BALCONERA 3 HOJAS ENTREMUROS Marco Inferior Oculto Tapas de Aluminio Marco 3 Carriles

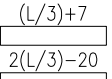
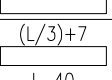

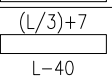
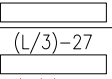
BALCONERA 3 HOJAS ENTREMUROS Marco Inferior Oculto Piso Corrido Marco 3 Carriles

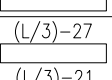
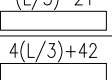
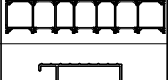
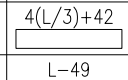
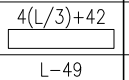
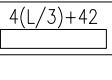

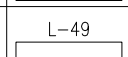
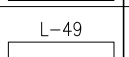
PERFILES

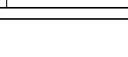
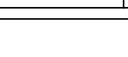
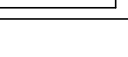
REFERENCIA	DENOMINACION	MARCO INFERIOR VISTO		MARCO INFERIOR OCULTO TAPAS ALUMINIO		MARCO INFERIOR OCULTO PISO CORRIDO	
		CANT.	CORTE	CANT.	CORTE	CANT.	CORTE
R-942	 +38.PP.020 (x2)	2	4(L/3)+46 	2	4(L/3)+46 	2	4(L/3)+46 
R-943		2	H-115 	2	H-138 	2	H-158 
R-945		4	(L/3)+10 	4	(L/3)+10 	4	(L/3)+10 
		2	(L/3)-2 	2	(L/3)-2 	2	(L/3)-2 
16.349				2	(L/3)+10 		
				1	(L/3)-2 		
16.651						2	(L/3)+10 
						1	(L/3)-2 
16.347		4	H-115 	4	H-138 	4	H-158 
16.341		1	H-37 	1	H-74 	1	H-94 
16.657		1	H-90 	1	H-90 	1	H-90 
16.658		1	H-115 	1	H-106 	1	H-126 
16.659		1	H-115 	1	H-106 	1	H-126 
13.248		2	H-90 	2	H-90 	2	H-112 
7.438		2	H-90 	2	H-90 	2	H-112 
16.342		4	2(L/3)-43 	2	2(L/3)-43 	2	2(L/3)-43 
		4	(L/3)-17 	2	(L/3)-17 	2	(L/3)-17 
		2	H-72 	2	H-72 	2	H-72 
16.343		2	2(L/3)-43 	1	2(L/3)-43 	1	2(L/3)-43 
		2	(L/3)-17 	1	(L/3)-17 	1	(L/3)-17 
		2	H-36 	2	H-36 	2	H-36 
16.344*				1	(L/3)+7 		
				1	2(L/3)-20 		
16.345*				1	(L/3)+7 	1	(L/3)-27 
				1	L-40 		
16.346*				1	(L/3)-27 	1	(L/3)-21 
16.608*				1	(L/3)-21 		
16.652*						1	(L/3)+7 
						1	2(L/3)-20 
16.653*						1	(L/3)+7 
						1	L-40 
16.654*						1	(L/3)-27 
						1	(L/3)-21 
R-949		1	4(L/3)+42 	1	4(L/3)+42 	1	4(L/3)+42 
15.686		1	L-49 	1	L-49 		
16.351		1	L-49 	1	L-49 	1	L-49 

BALCONERA 3 HOJAS ENTREMUROS
Marco 3 Carriles

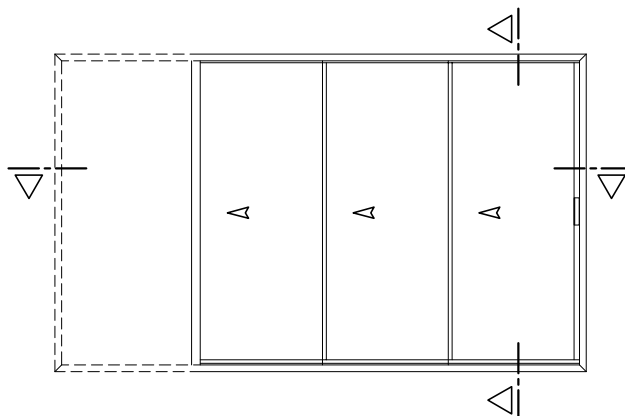

ACCESORIOS

REFERENCIA	DENOMINACION	M.INF. VISTO	M.INF. OCULTO TAPAS ALUMINIO	M.INF. OCULTO PISO CORRIDO
		UNIDADES	UNIDADES	UNIDADES
04.AC.848	Cremona 3 puntos	1	1	1
04.AC.055.M	Cerradero	3	3	3
04.AC.056	Embellecedor Cerradero	3	3	3
04.AC.854	Manilla Izda.	1	1	1
04.AC.067	Kit Hoja Lateral	2	2	2
04.AC.068	Kit Hoja Central	6		
04.AC.069	Kit H.Central M.Inf. Oculto Tapas Aluminio		6	
04.AC.070	Kit H.Central M.Inf. Oculto Piso Corrido			6
04.AC.078	Tapa H.Lateral M.Inf. Oculto Tapas Aluminio		2	
04.AC.079	Tapa H.Lateral M.Inf. Oculto Piso Corrido			2
04.AC.071	Kit Cortavientos	4	1	1
04.AC.080	Kit Cortavientos M.Inf. Oculto		2	2
04.AC.075	Taco Estanq. M.Inf. Oculto Tapas Aluminio		1	
04.AC.081	Taco Estanq. M.Inf. Oculto Piso Corrido			1
04.ES.083	Escuadra Marco	12	12	12
04.AC.F10	Felpudo Marco	4L+3H	2L+3H	6L+3H
04.AC.F09	Felpudo Suplementos Hoja 16.349 y 16.651		2L	2L
04.AC.F11	Felpudo Cierre Entremuros	H	H	H
04.JU.004.D	Junta Cierre Lateral	2H	2H	2H
04.JU.062	Junta Cruce Central	4H	4H	4H
04.JU.067	Junta Cruce Central	4H	4H	4H
04.JU.068	Junta Tapa canal Marco	4L	4L	4L
04.JU.069	Junta Carril	x6 4(L/3)-205	4(L/3)-205	4(L/3)-205
04.AC.R150	Carril Acero Inox.	x6 4(L/3)-205	4(L/3)-205	4(L/3)-205
04.AC.R151	Rodamiento	6	6	6
04.AC.R153	Kit Angulo Rod. M.Inf. Oculto Tapas Aluminio		3	
04.AC.R154	Kit Angulo Rod. M.Inf. Oculto Piso Corrido			3
04.TA.070	Tapa para Canaleta	2	2	2
04.TA.072	Tapa para Solera	2	2	2
04.AC.073	Calzo Vidrio	Según dimensiones de Vidrio		

*Se indica la longitud total necesaria. Las tapas se colocan en tramos para permitir el montaje.

En caso de piso corrido las tapas que ocultan el marco inferior deben de ser registrables para permitir sacar la hoja en caso de necesidad.

BALCONERA 4 HOJAS ENTREMUROS Marco 4 Carriles

$5(L/4)+69$

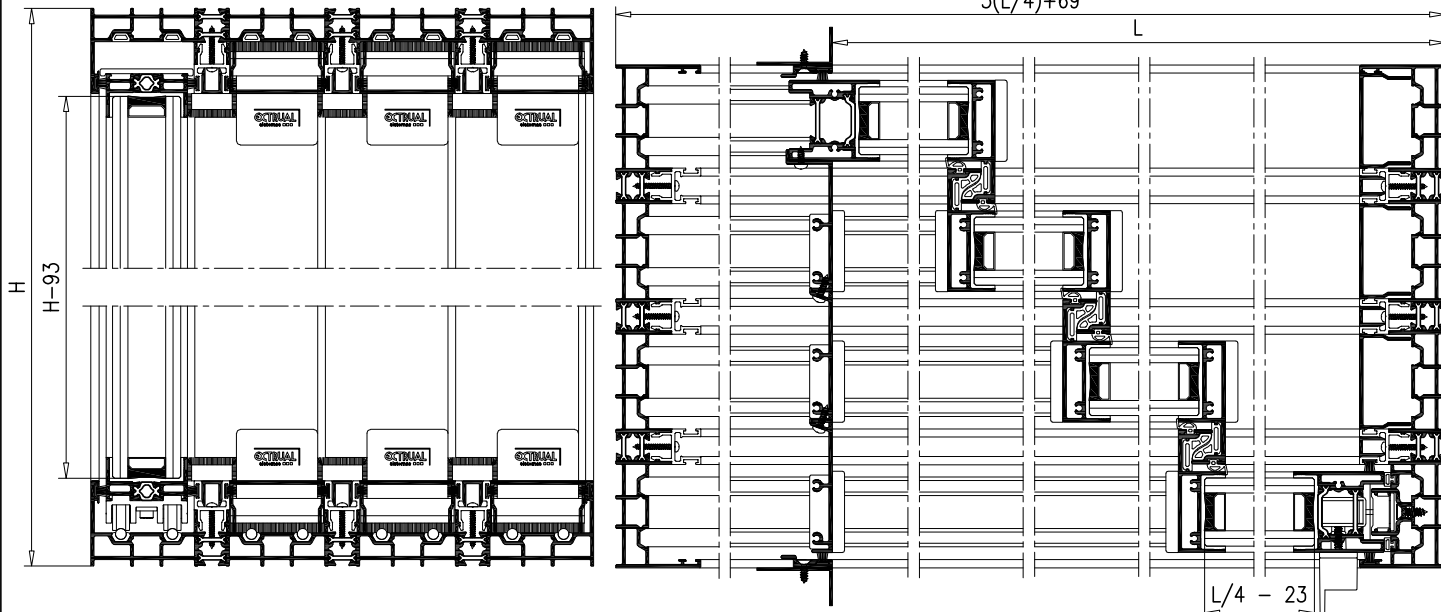

BALCONERA 4 HOJAS ENTREMUROS Marco Inferior Oculto Tapas de Aluminio Marco 4 Carriles

$5(L/4)+69$

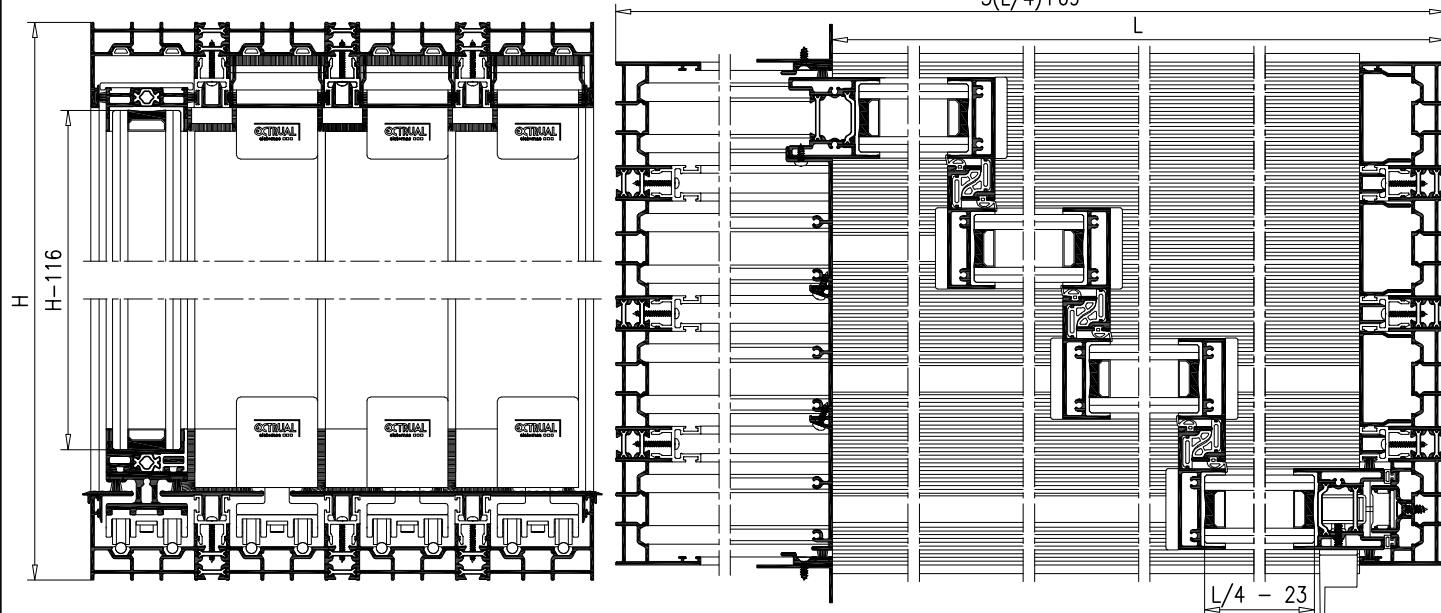





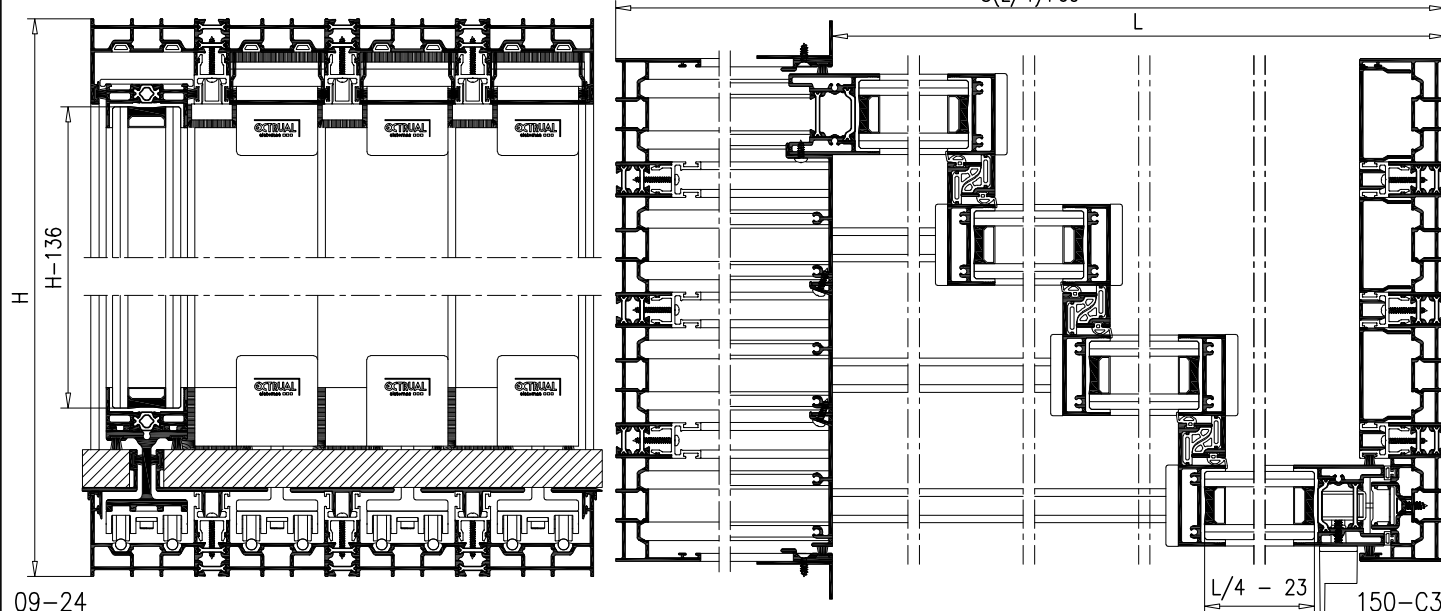















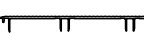

BALCONERA 4 HOJAS ENTREMUROS Marco Inferior Oculto Piso Corrido Marco 4 Carriles

$5(L/4)+69$

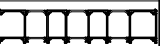

PERFILES

REFERENCIA	DENOMINACION	MARCO INFERIOR VISTO		MARCO INFERIOR OCULTO TAPAS ALUMINIO		MARCO INFERIOR OCULTO PISO CORRIDO		
		CANT.	CORTE	CANT.	CORTE	CANT.	CORTE	
R-952		MARCO	2	5(L/4)-21	2	5(L/4)-21	2	5(L/4)-21
			2	H	2	H	2	H
+38.PP.020 (x3)								
R-943		HOJA LATERAL	2	H-115	2	H-138	2	H-158
R-945		HOJA SUP/INF	4	(L/4)+17	4	(L/4)+17	4	(L/4)+17
			4	(L/4)+5	4	(L/4)+5	4	(L/4)+5
16.349		SUPLEMENT. HOJA			2	(L/4)+17		
					2	(L/4)+5		
16.651		SUPLEMENT. HOJA					2	(L/4)+17
							2	(L/4)+5
16.347		HOJA DE CIERRE	4	H-115	4	H-138	4	H-158
16.341		CIERRE LATERAL	1	H-37	1	H-74	1	H-94
5.787		ANGULO 40x20	2	H-90	2	H-90	2	H-90
16.657		CRUCE ENTREMUEOS	1	H-90	1	H-90	1	H-90
16.658		TAPA LAT. ENTREMUEOS	1	H-115	1	H-106	1	H-126
16.659		SUPLEMENTO TAPA LAT. ENTREMUEOS	2	H-115	2	H-106	2	H-126
16.342		TAPA CANAL	4	3(L/4)-50	2	3(L/4)-50	2	3(L/4)-50
			4	(L/2)-30	2	(L/2)-30	2	(L/2)-30
			4	(L/4)-10	4	(L/4)-10	4	(L/4)-10
			3	H-72	3	H-72	3	H-72
16.343		TAPA MARCO	2	3(L/4)-50	1	3(L/4)-50	1	3(L/4)-50
			2	(L/2)-30	1	(L/2)-30	1	(L/2)-30
			2	(L/4)-10	1	(L/4)-10	1	(L/4)-10
			2	H-36	2	H-36	2	H-36
16.344*		TAPA CENTRAL			1	(L/4)+5		
					1	(L/4)+15		
16.345*		TAPA LATERAL			1	(L/4)+5		(L/4)-20
					1	(L/4)+15		
16.346*		TAPA DOBLE			2	(L/4)-20		(L/2)-30
16.608*		TAPA TRIPLE			4	(L/2)-30		(L/4)-10
16.652*		TAPA CENTRAL					1	(L/4)+5
							1	(L/2)-40
							1	3(L/4)-60
16.653*		TAPA LATERAL					1	(L/4)+5
							1	L-45
16.654*		TAPA MULTIPLE					1	(L/4)+15
							1	(L/2)-5
							1	3(L/4)-25
R-949		SOLERA	1	5(L/4)+65	1	5(L/4)+65	1	5(L/4)+65
15.686		TAPA CANALETA	1	L-66	1	L-66		
16.351		CANALETA DRENAJE	1	L-66	1	L-66	1	L-66

EXTRUAL

sistemas

E 150

BALCONERA 4 HOJAS ENTREMUEOS Marco 4 Carriles Corte Recto

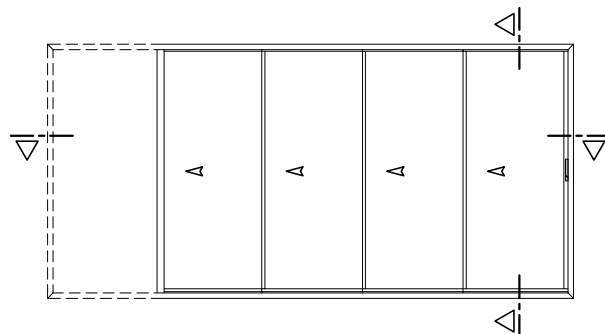

ACCESORIOS

REFERENCIA	DENOMINACION	M.INF. VISTO	M.INF. OCULTO TAPAS ALUMINIO	M.INF. OCULTO PISO CORRIDO
		UNIDADES	UNIDADES	UNIDADES
04.AC.848	Cremona 3 puntos	1	1	1
04.AC.055.M	Cerradero	3	3	3
04.AC.056	Embellecedor Cerradero	3	3	3
04.AC.853	Manilla Dcha.	1	1	1
04.AC.067	Kit Hoja Lateral	2	2	2
04.AC.068	Kit Hoja Central	6		
04.AC.069	Kit H.Central M.Inf. Oculto Tapas Aluminio		6	
04.AC.078	Kit H.Central M.Inf. Oculto Piso Corrido			6
04.AC.070	Tapa H.Lateral M.Inf. Oculto Tapas Aluminio		2	
04.AC.079	Tapa H.Lateral M.Inf. Oculto Piso Corrido			2
04.AC.071	Kit Cortavientos	6	2	2
04.AC.080	Kit Cortavientos M.Inf. Oculto		3	3
04.AC.075	Taco Estanq. M.Inf. Oculto Tapas Aluminio		1	
04.AC.081	Taco Estanq. M.Inf. Oculto Piso Corrido			1
04.TO.025	Tocho de unión	16	16	16
04.AC.F10	Felpudo Marco	4L+4H	2L+4H	6L+4H
04.AC.F09	Felpudo Suplementos Hoja 16.349 y 16.651		2L	2L
04.JU.004.D	Junta Cierre Lateral	2H	2H	2H
04.JU.062	Junta Cruce Central	6H	6H	6H
04.JU.067	Junta Cruce Central	6H	6H	6H
04.JU.068	Junta Tapa canal Marco	5L	5L	5L
04.JU.069	Junta Carril	~6L	~6L	~6L
04.AC.R150	Carril Acero Inox.	~6L	~6L	~6L
04.AC.R151	Rodamiento	8	8	8
04.AC.R153	Kit Angulo Rod. M.Inf. Oculto Tapas Aluminio		4	
04.AC.R154	Kit Angulo Rod. M.Inf. Oculto Piso Corrido			4
04.TA.070	Tapa para Canaleta	2	2	2
04.TA.072	Tapa para Solera	2	2	2
04.AC.073	Calzo Vidrio	Según dimensiones de Vidrio		

*Se indica la longitud total necesaria. Las tapas se colocan en tramos para permitir el montaje.

En caso de piso corrido las tapas que ocultan el marco inferior deben de ser registrables para permitir sacar la hoja en caso de necesidad.

BALCONERA EN ESQUINA SALIENTE 1+1 HOJAS ENTREMUROS

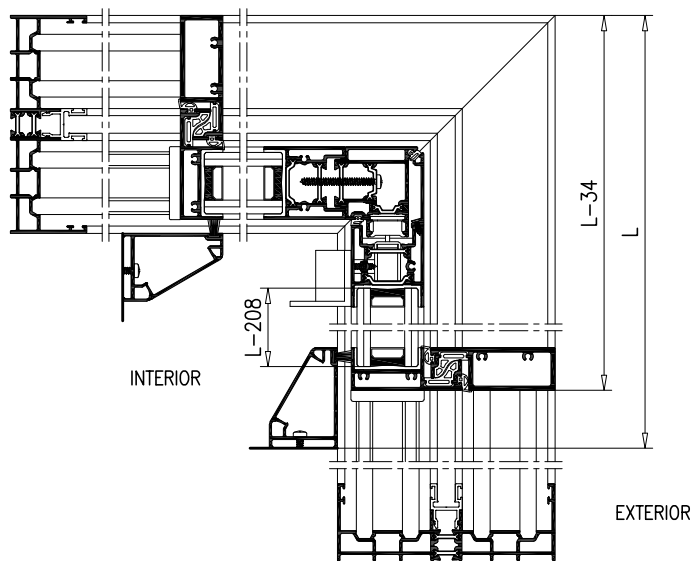
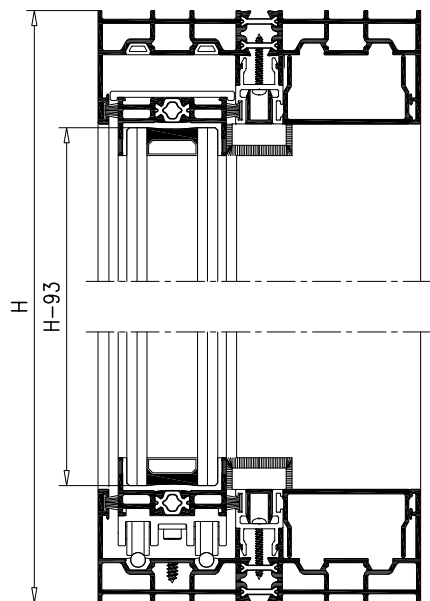

BALCONERA EN ESQUINA SALIENTE 1+1 HOJAS ENTREMUROS
Marco Interior Oculto Tapas de Aluminio

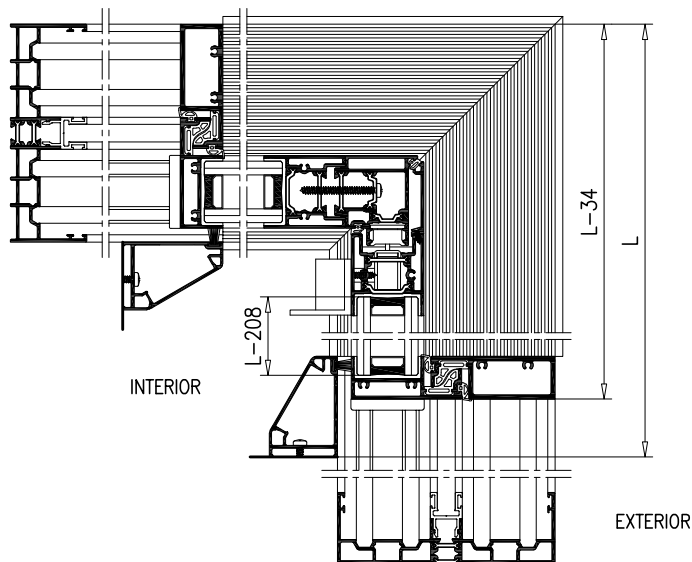
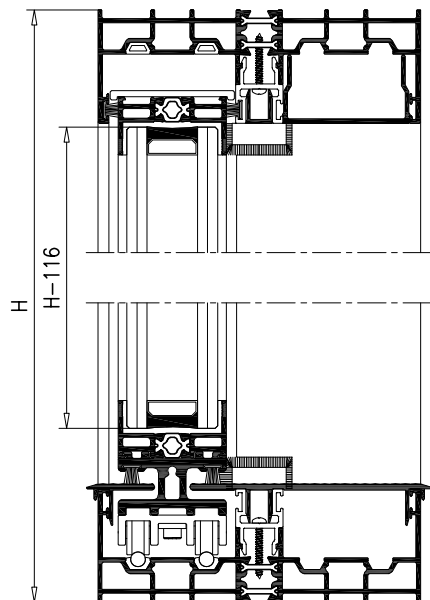

BALCONERA EN ESQUINA SALIENTE 1+1 HOJAS ENTREMUROS
Marco Inferior Oculto Piso Corrido

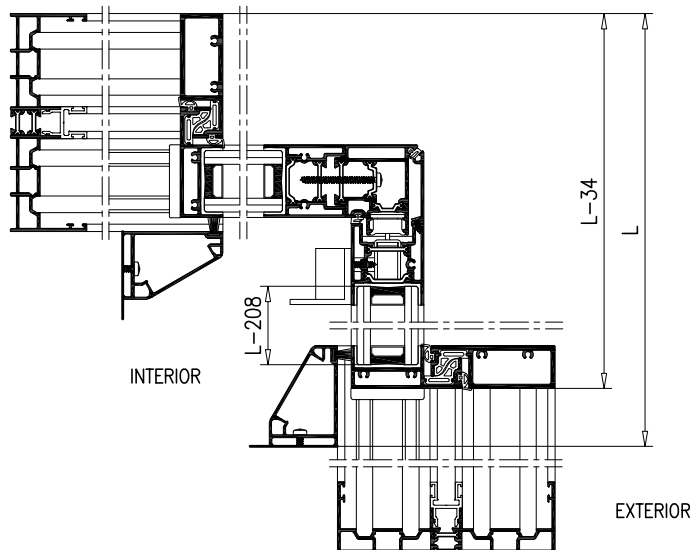
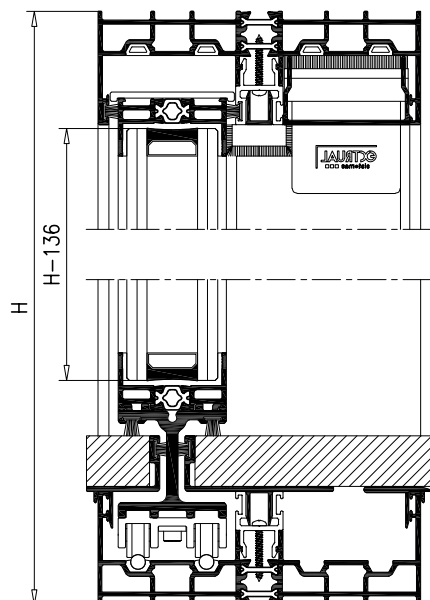

BALCONERA EN ESQUINA SALIENTE 1+1 HOJAS ENTREMUROS

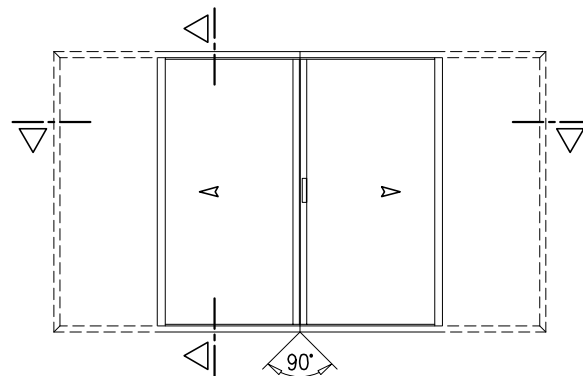

PERFILES

REFERENCIA	DENOMINACION	MARCO INFERIOR VISTO		MARCO INFERIOR OCULTO TAPAS ALUMINIO		MARCO INFERIOR OCULTO PISO CORRIDO	
		CANT.	CORTE	CANT.	CORTE	CANT.	CORTE
R-941	MARCO +38.PP.020	4 2	(2L)-219 H	4 2	(2L)-219 H	4 2	(2L)-219 H
16.350	PERFIL DE CIERRE	2	H-35	2	H-35	2	H-35
R-943	HOJA LATERAL	2	H-115	2	H-138	2	H-158
R-945	HOJA SUP/INF	4	L-168	4	L-168	4	L-168
16.349	SUPLEMENT. HOJA			2	L-168		
16.651	SUPLEMENT. HOJA					2	L-168
16.347	HOJA DE CIERRE	2	H-115	2	H-138	2	H-158
R-947	HOJA ESQUINA	1	H-69	1	H-94	1	H-114
16.358	CIERRE ESQUINA	1	H-69	1	H-94	1	H-114
16.342	TAPA CANAL	4	L-118	2	L-118	2	L-118
16.343	TAPA MARCO	2	L-63	1	L-63	1	L-63
13.248	CIERRE ENTREMUROS	2	H-90	2	H-90	2	H-112
7.438	TAPETA PARA 13.248	2	H-90	2	H-90	2	H-112
16.345*	TAPA LATERAL			2	L-164	2	L-54
16.346*	TAPA DOBLE			2	L-54		
16.653*	TAPA LATERAL					2	L-162
16.654*	TAPA MULTIPLE					2	L-93
R-948	SOLERA	2	(2L)-219	2	(2L)-219	2	(2L)-219
15.686	TAPA CANALETA	2	L+29	2	L+29		
16.351	CANALETA DRENAJE	2	L+31	2	L+31	2	L+31

ACCESORIOS

REFERENCIA	DENOMINACION	M.INF. VISTO	M.INF. OCULTO TAPAS ALUMINIO	M.INF. OCULTO PISO CORRIDO
		UNIDADES	UNIDADES	UNIDADES
04.AC.848	Cremona 3 puntos	1	1	1
04.AC.055.M	Cerradero	3	3	3
04.AC.056	Embellecedor Cerradero	3	3	3
04.AC.854	Manilla Izda.	1	1	1
04.AC.845	Tirador	1	1	1
04.AC.067	Kit Hoja Lateral	2	2	2
04.AC.068	Kit Hoja Central	2		
04.AC.069	Kit H.Central M.Inf. Oculto Tapas Aluminio		2	
04.AC.078	Kit H.Central M.Inf. Oculto Piso Corrido			2
04.AC.070	Tapa H.Lateral M.Inf. Oculto Tapas Aluminio		2	
04.AC.079	Tapa H.Lateral M.Inf. Oculto Piso Corrido			2
04.AC.071	Kit Cortavientos	2		
04.AC.080	Kit Cortavientos Marco Inferior Oculto		2	2
04.AC.077	Kit Cierre Esquina Marco Inf. Oculto		1	1
04.ES.083	Escuadra Marco	8	8	8
04.ES.084	Escuadra Marco Esquina	4	4	4
04.AC.F10	Felpudo Marco	8L	4L	8L
04.AC.F09	Felpudo Suplementos Hoja 16.349 y 16.651		4L	4L
04.JU.004.E	Junta Cierre Esquina	2H	2H	2H
04.JU.062	Junta Cruce Central	2H	2H	2H
04.JU.067	Junta Cruce Central	2H	2H	2H
04.JU.068	Junta Tapacanal Marco	4L	4L	4L
04.JU.069	Junta Carril	x2	(2L)-520	(2L)-520
04.AC.R150	Carril Acero Inox.	x2	(2L)-520	(2L)-520
04.AC.R151	Rodamiento	4	4	4
04.AC.R153	Kit Angulo Rod. M.Inf. Oculto Tapas Aluminio		2	
04.AC.R154	Kit Angulo Rod. M.Inf. Oculto Piso Corrido			2
04.TA.070	Tapa para Canaleta	2	2	2
04.TA.071	Tapa para Solera	2	2	2
04.AC.073	Calzo Vidrio	Según dimensiones de Vidrio		

*Se indica la longitud total necesaria. Las tapas se colocan en tramos para permitir el montaje.

En caso de piso corrido las tapas que ocultan el marco inferior deben de ser registrables para permitir sacar la hoja en caso de necesidad.

BALCONERA EN ESQUINA ENTRANTE 1+1 HOJAS ENTREMUROS

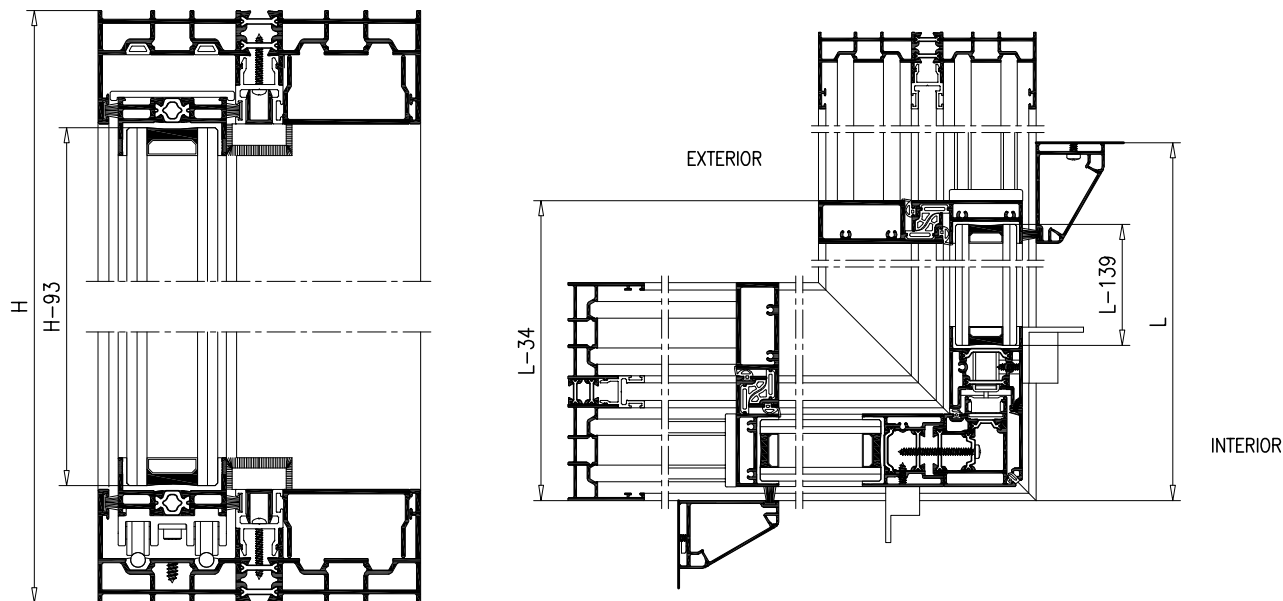

BALCONERA EN ESQUINA ENTRANTE 1+1 HOJAS ENTREMUROS
Marco Inferior Oculto Tapas de Aluminio

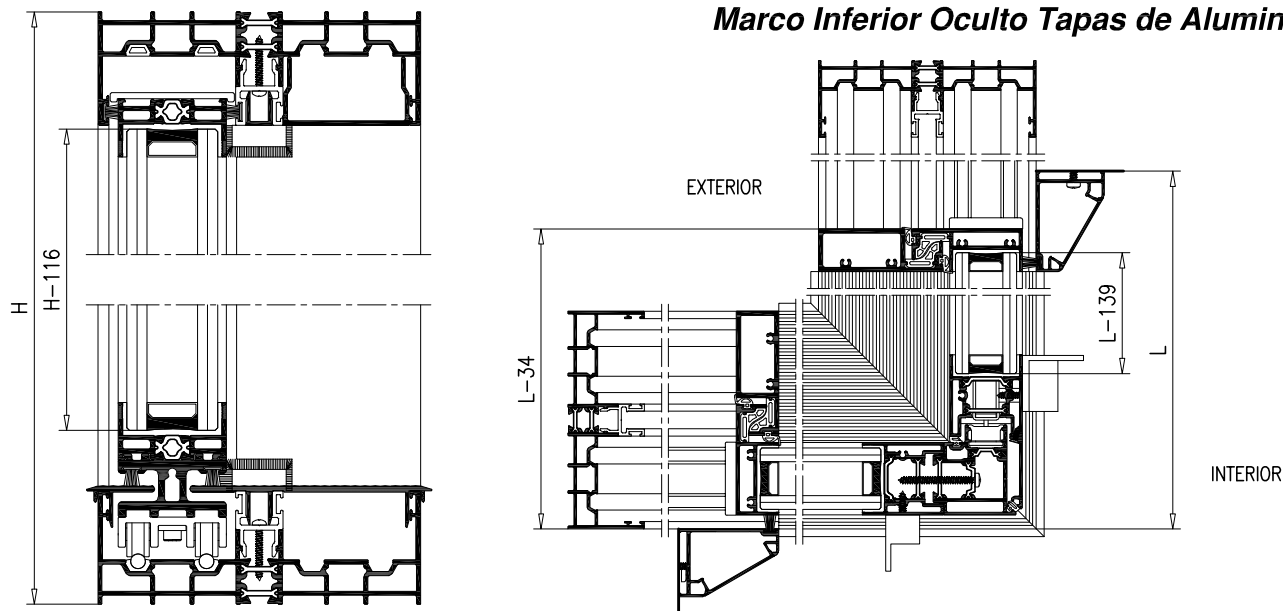

BALCONERA EN ESQUINA ENTRANTE 1+1 HOJAS ENTREMUROS
Marco Inferior Oculto Piso Corrido

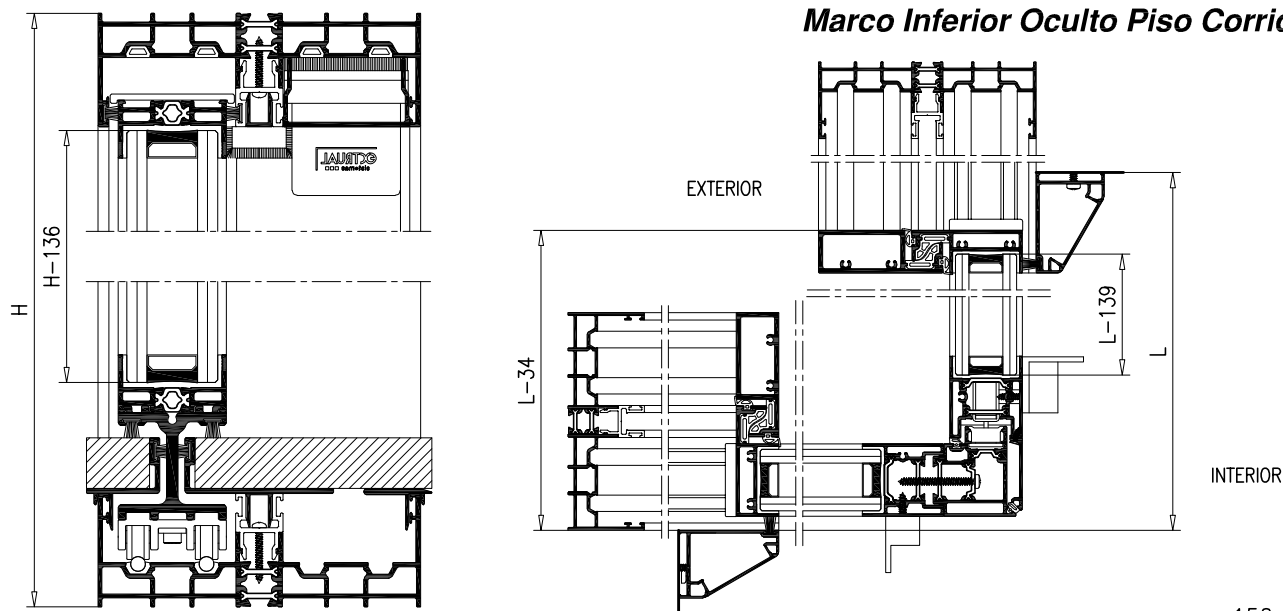

BALCONERA EN ESQUINA ENTRANTE 1+1 HOJAS ENTREMUROS

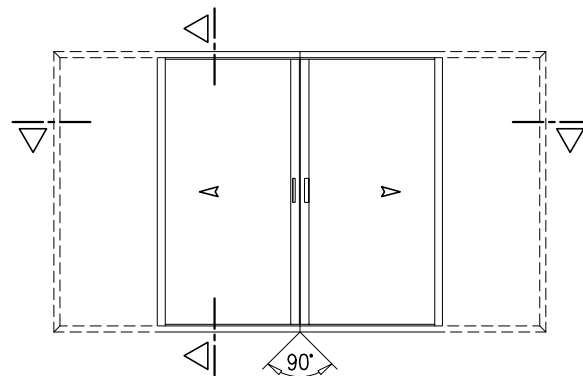

PERFILES

REFERENCIA	DENOMINACION	MARCO INFERIOR VISTO		MARCO INFERIOR OCULTO TAPAS ALUMINIO		MARCO INFERIOR OCULTO PISO CORRIDO	
		CANT.	CORTE	CANT.	CORTE	CANT.	CORTE
R-941	MARCO +38.PP.020	4 2	(2L)-148 H	4 2	(2L)-148 H	4 2	(2L)-148 H
16.350	PERFIL DE CIERRE	2	H-35	2	H-35	2	H-35
R-943	HOJA LATERAL	2	H-115	2	H-138	2	H-158
R-945	HOJA SUP/INF	4	L-99	4	L-99	4	L-99
16.349	SUPLEMENT. HOJA			2	L-99		
16.651	SUPLEMENT. HOJA					2	L-99
16.347	HOJA DE CIERRE	2	H-115	2	H-138	2	H-158
R-947	HOJA ESQUINA	1	H-69	1	H-94	1	H-114
16.358	CIERRE ESQUINA	1	H-69	1	H-94	1	H-114
16.342	TAPA CANAL	4	L-118	2	L-118	2	L-118
16.343	TAPA MARCO	2	L-132	1	L-132	1	L-132
13.248	CIERRE ENTREMUROS	2	H-90	2	H-90	2	H-112
7.438	TAPETA PARA 13.248	2	H-90	2	H-90	2	H-112
16.345*	TAPA LATERAL			2	L-81	2	L-164
16.346*	TAPA DOBLE			2	L-95		
16.653*	TAPA LATERAL					2	L-83
16.654*	TAPA MULTIPLE					2	L-93
R-948	SOLERA	2	(2L)-148	2	(2L)-148	2	(2L)-148
15.686	TAPA CANALETA	2	L-192	2	L-192		
16.351	CANALETA DRENAJE	2	L-189	2	L-189	2	L-189

ACCESORIOS

REFERENCIA	DENOMINACION	M.INF. VISTO	M.INF. OCULTO TAPAS ALUMINIO	M.INF. OCULTO PISO CORRIDO
		UNIDADES	UNIDADES	UNIDADES
04.AC.848	Cremona 3 puntos	1	1	1
04.AC.055.M	Cerradero	3	3	3
04.AC.056	Embellecedor Cerradero	3	3	3
04.AC.854	Manilla Dcha.	1	1	1
04.AC.845	Tirador	1	1	1
04.AC.067	Kit Hoja Lateral	2	2	2
04.AC.068	Kit Hoja Central	2		
04.AC.069	Kit H.Central M.Inf. Oculto Tapas Aluminio		2	
04.AC.078	Kit H.Central M.Inf. Oculto Piso Corrido			2
04.AC.070	Tapa H.Lateral M.Inf. Oculto Tapas Aluminio		2	
04.AC.079	Tapa H.Lateral M.Inf. Oculto Piso Corrido			2
04.AC.071	Kit Cortavientos	2		
04.AC.080	Kit Cortavientos Marco Inferior Oculto		2	2
04.AC.077	Kit Cierre Esquina Marco Inf. Oculto		1	1
04.ES.083	Escuadra Marco	8	8	8
04.ES.084	Escuadra Marco Esquina	4	4	4
04.AC.F10	Felpudo Marco	8L	4L	8L
04.AC.F09	Felpudo Suplementos Hoja 16.349 y 16.651		4L	4L
04.JU.004.E	Junta Cierre Esquina	2H	2H	2H
04.JU.062	Junta Cruce Central	2H	2H	2H
04.JU.067	Junta Cruce Central	2H	2H	2H
04.JU.068	Junta Tapacanal Marco	4L	4L	4L
04.JU.069	Junta Carril	x2	(2L)-450	(2L)-450
04.AC.R150	Carril Acero Inox.	x2	(2L)-450	(2L)-450
04.AC.R151	Rodamiento	4	4	4
04.AC.R153	Kit Angulo Rod. M.Inf. Oculto Tapas Aluminio		2	
04.AC.R154	Kit Angulo Rod. M.Inf. Oculto Piso Corrido			2
04.TA.070	Tapa para Canaleta	2	2	2
04.TA.071	Tapa para Solera	2	2	2
04.AC.073	Calzo Vidrio	Según dimensiones de Vidrio		

*Se indica la longitud total necesaria. Las tapas se colocan en tramos para permitir el montaje.

En caso de piso corrido las tapas que ocultan el marco inferior deben de ser registrables para permitir sacar la hoja en caso de necesidad.

BALCONERA EN ESQUINA SALIENTE 2+2 HOJAS

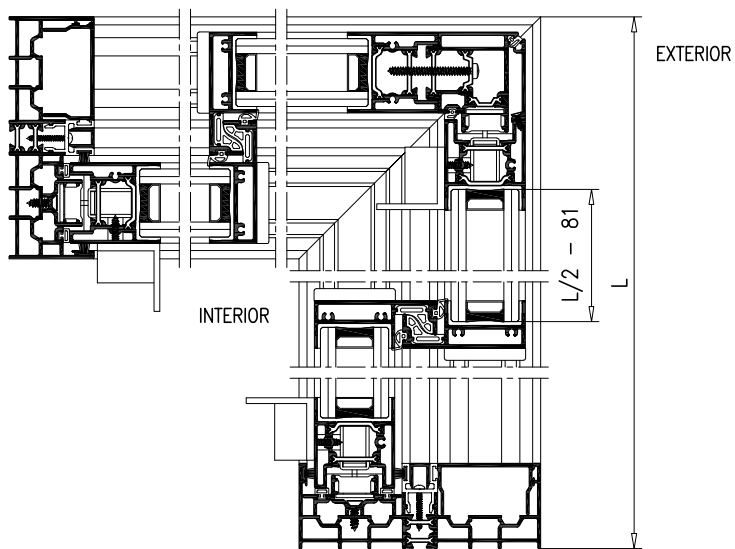
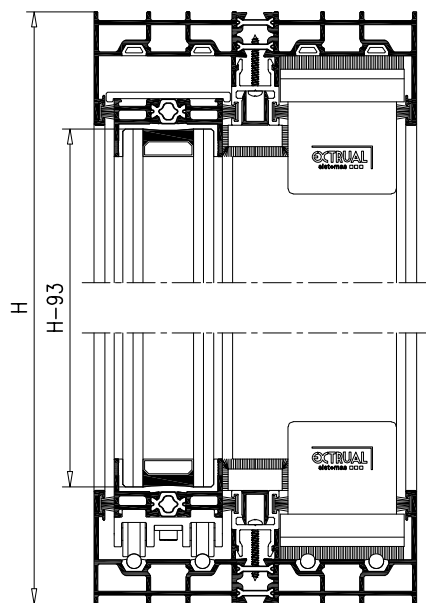

BALCONERA EN ESQUINA SALIENTE 2+2 HOJAS
Marco Inferior Oculto Tapas de Aluminio

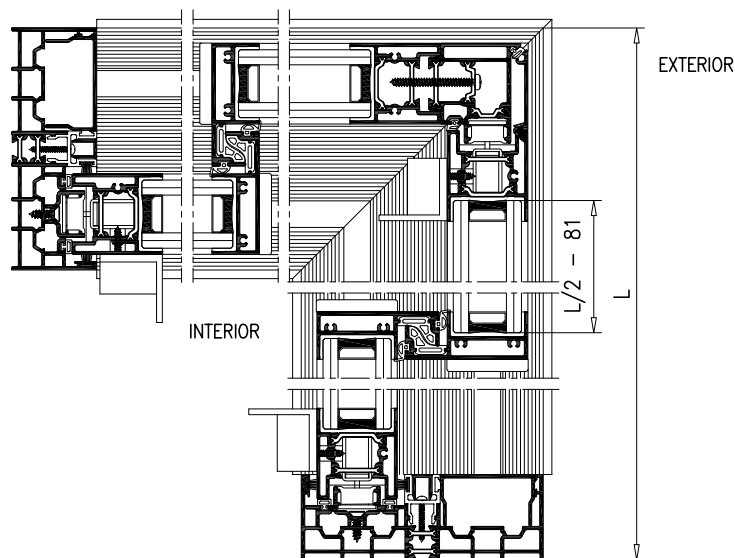
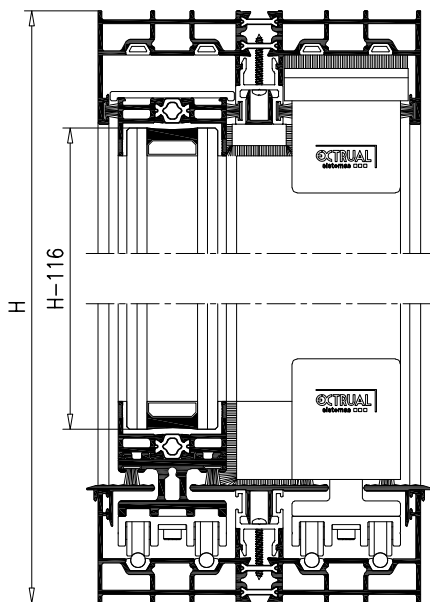



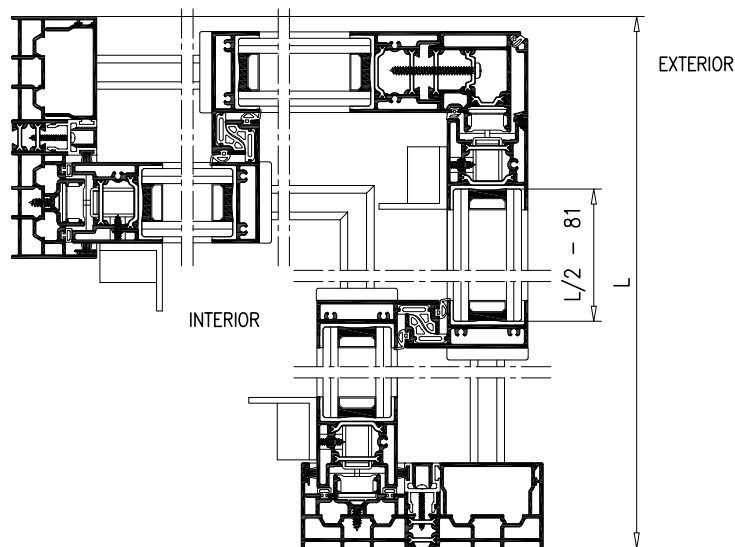
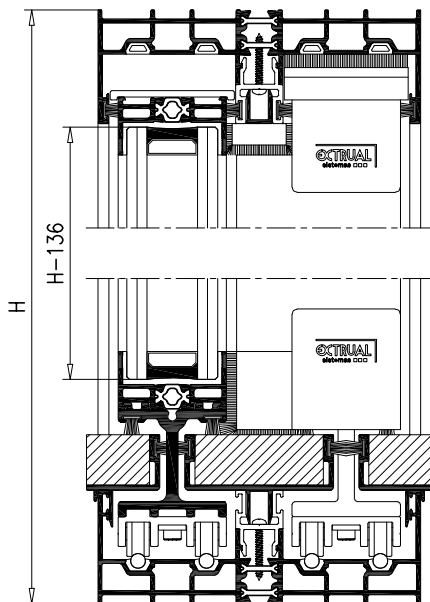





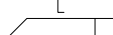
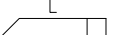
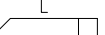
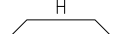
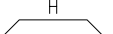
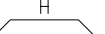

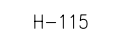
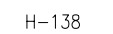
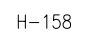

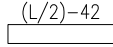
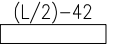
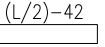

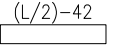

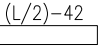

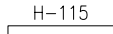
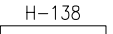
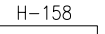

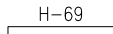
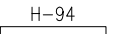
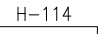

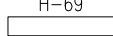
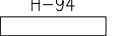
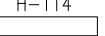
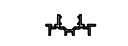
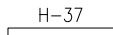
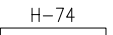
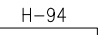

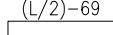
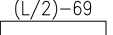
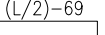
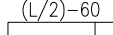
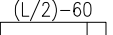
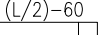
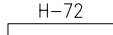
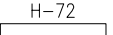
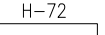

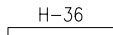
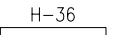
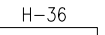
BALCONERA EN ESQUINA SALIENTE 2+2 HOJAS
Marco Inferior Oculto Piso Corrido

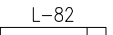

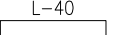
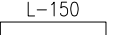
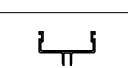
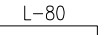
BALCONERA EN ESQUINA SALIENTE 2+2 HOJAS

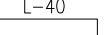
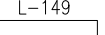
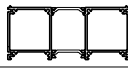
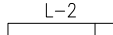
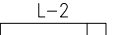
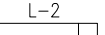
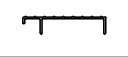
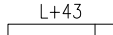
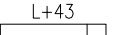
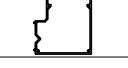
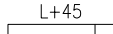
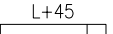
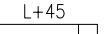
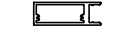
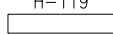
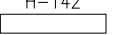
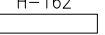
PERFILES

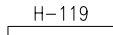
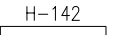
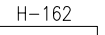
REFERENCIA	DENOMINACION	MARCO INFERIOR VISTO		MARCO INFERIOR OCULTO TAPAS ALUMINIO		MARCO INFERIOR OCULTO PISO CORRIDO	
		CANT.	CORTE	CANT.	CORTE	CANT.	CORTE
R-941	MARCO  +38.PP.020	4		4		4	
		2		2		2	
R-943	HOJA LATERAL 	4	H-115 	4	H-138 	4	H-158 
R-945	HOJA SUP/INF 	8	(L/2)-42 	8	(L/2)-42 	8	(L/2)-42 
16.349	SUPLEMENT. HOJA 			4	(L/2)-42 		
16.651	SUPLEMENT. HOJA 					4	(L/2)-42 
16.347	HOJA DE CIERRE 	4	H-115 	4	H-138 	4	H-158 
R-947	HOJA ESQUINA 	1	H-69 	1	H-94 	1	H-114 
16.358	CIERRE ESQUINA 	1	H-69 	1	H-94 	1	H-114 
16.341	CIERRE LATERAL 	2	H-37 	2	H-74 	2	H-94 
16.342	TAPA CANAL 	4	(L/2)-69 	2	(L/2)-69 	2	(L/2)-69 
		4	(L/2)-60 	2	(L/2)-60 	2	(L/2)-60 
		2	H-72 	2	H-72 	2	H-72 
16.343	TAPA MARCO 	2	H-36 	2	H-36 	2	H-36 
16.344*	TAPA CENTRAL 			2	L-82 		
16.345*	TAPA LATERAL 			2	L-40 		
				2	L-150 		
16.652*	TAPA CENTRAL 					2	L-80 
16.653*	TAPA LATERAL 					2	L-40 
						2	L-149 
R-948	SOLERA 	2	L-2 	2	L-2 	2	L-2 
15.686	TAPA CANALETA 	2	L+43 	2	L+43 		
16.351	CANALETA DRENAJE 	2	L+45 	2	L+45 	2	L+45 
16.348	REFUERZO TIRADOR 	4	H-119 	2	H-142 	2	H-162 
10.466	TAPETA TIRADOR 	4	H-119 	2	H-142 	2	H-162 

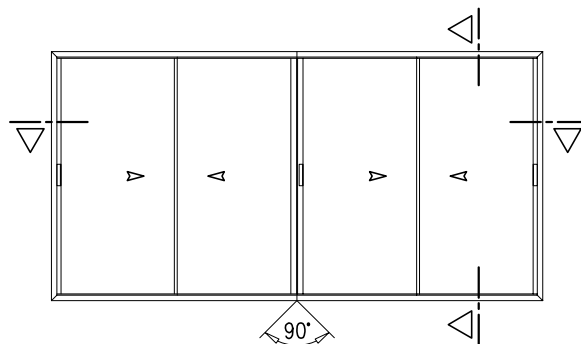

ACCESORIOS

REFERENCIA	DENOMINACION	M.INF. VISTO	M.INF. OCULTO TAPAS ALUMINIO	M.INF. OCULTO PISO CORRIDO
		UNIDADES	UNIDADES	UNIDADES
04.AC.848	Cremona 3 puntos	3	3	3
04.AC.055.M	Cerradero	9	9	9
04.AC.056	Embellecedor Cerradero	9	9	9
04.AC.853	Manilla Dcha.	2	2	2
04.AC.854	Manilla Izda.	1	1	1
04.AC.845	Tirador	1	1	1
04.AC.067	Kit Hoja Lateral	4	4	4
04.AC.068	Kit Hoja Central	4		
04.AC.069	Kit H.Central M.Inf. Oculto Tapas Aluminio		4	
04.AC.070	Kit H.Central M.Inf. Oculto Piso Corrido			4
04.AC.078	Tapa H.Lateral M.Inf. Oculto Tapas Aluminio		4	
04.AC.079	Tapa H.Lateral M.Inf. Oculto Piso Corrido			4
04.AC.071	Kit Cortavientos	2		
04.AC.080	Kit Cortavientos Marco Inferior Oculto		2	2
04.AC.075	Taco Estanq. M.Inf. Oculto Tapas Aluminio		2	
04.AC.081	Taco Estanq. M.Inf. Oculto Piso Corrido			2
04.AC.077	Kit Cierre Esquina Marco Inf. Oculto		1	1
04.ES.083	Escuadra Marco	8	8	8
04.ES.084	Escuadra Marco Esquina	4	4	4
04.AC.F10	Felpudo Marco	8L+4H	4L+4H	12L+4H
04.AC.F09	Felpudo Suplementos Hoja 16.349 y 16.651		4L	4L
04.JU.004.D	Junta Cierre Lateral	4H	4H	4H
04.JU.004.E	Junta Cierre Esquina	2H	2H	2H
04.JU.062	Junta Cruce Central	4H	4H	4H
04.JU.067	Junta Cruce Central	4H	4H	4H
04.JU.068	Junta Tapacanal Marco	4L	4L	4L
04.JU.069	Junta Carril	x8 L-300	L-300	L-300
04.AC.R150	Carril Acero Inox.	x8 L-300	L-300	L-300
04.AC.R151	Rodamiento	8	8	8
04.AC.R153	Kit Angulo Rod. M.Inf. Oculto Tapas Aluminio		4	
04.AC.R154	Kit Angulo Rod. M.Inf. Oculto Piso Corrido			4
04.TA.069	Juego Tapas Tirador	4	4	4
04.TA.070	Tapa para Canaleta	2	2	2
04.TA.071	Tapa para Solera	2	2	2
04.AC.073	Calzo Vidrio	Según dimensiones de Vidrio		

*Se indica la longitud total necesaria. Las tapas se colocan en tramos para permitir el montaje.

El perfil 16.651 se coloca deslizado en la hoja inferior en 2 trozos, para permitir sacar la hoja del marco en caso de necesidad una vez colocado el piso.

BALCONERA EN ESQUINA ENTRANTE 2+2 HOJAS

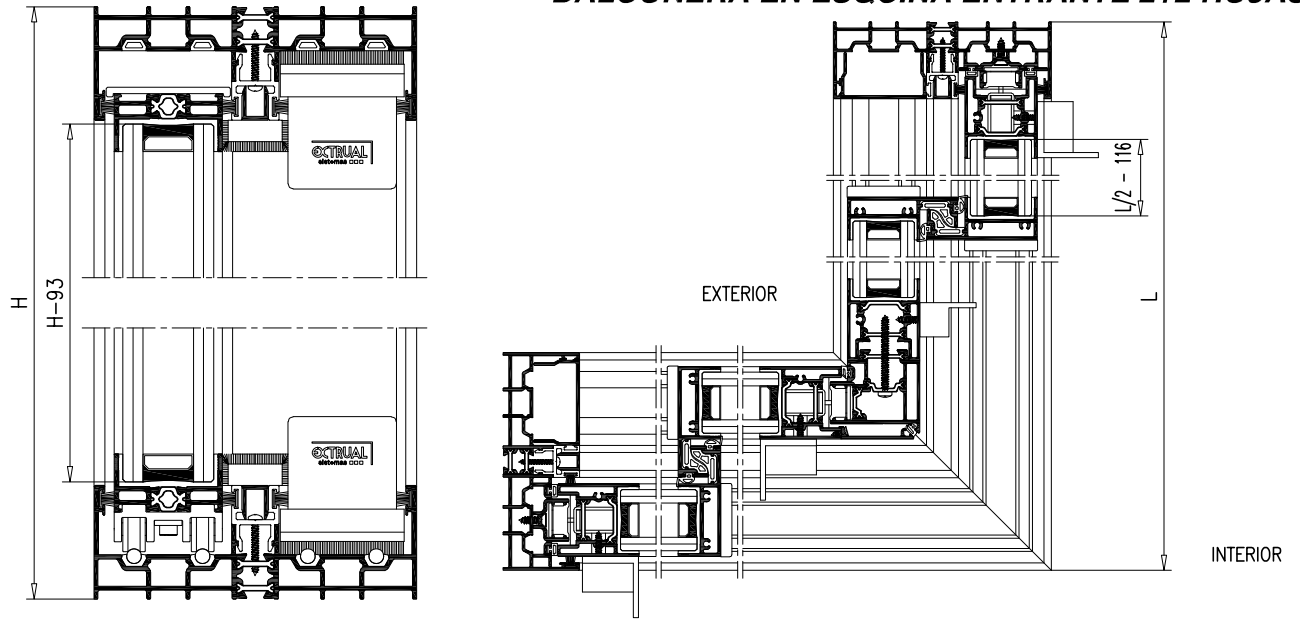

BALCONERA EN ESQUINA ENTRANTE 2+2 HOJAS Marco Inferior Oculto Tapas de Aluminio

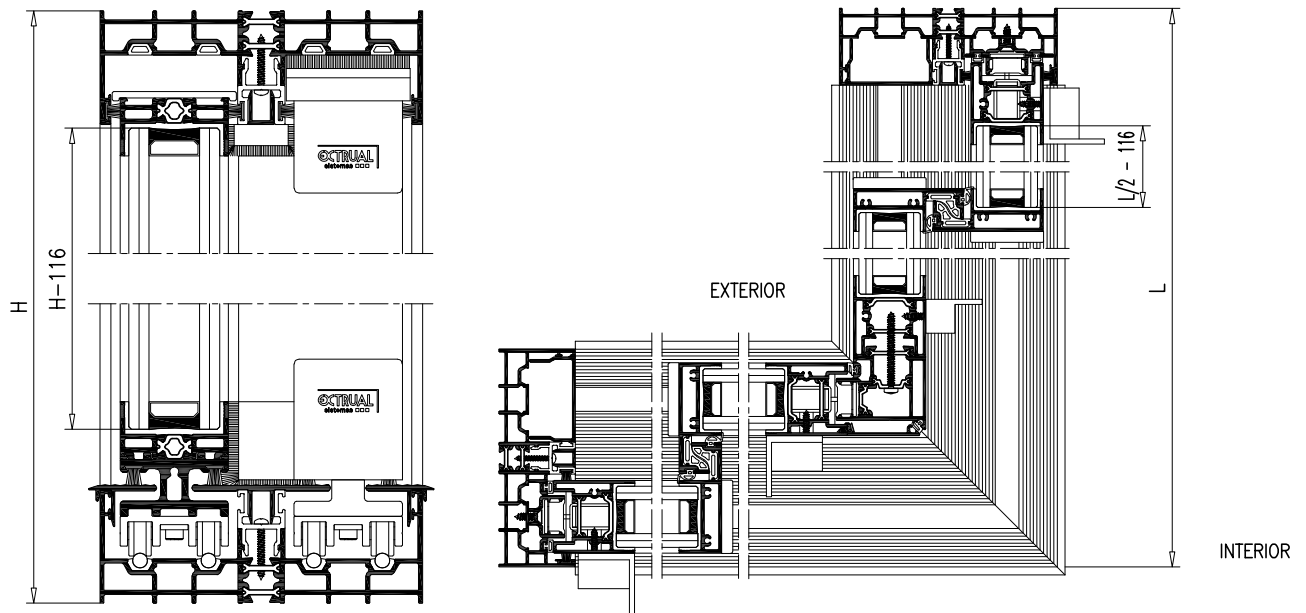

BALCONERA EN ESQUINA ENTRANTE 2+2 HOJAS Marco Inferior Oculto Piso Corrido

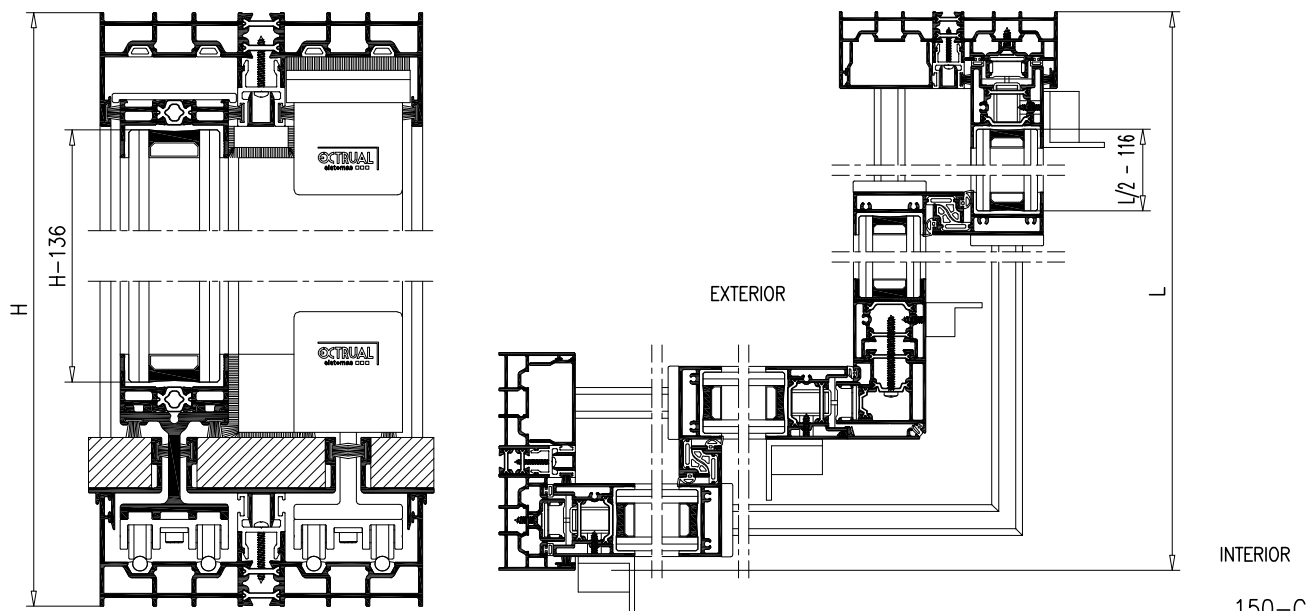

BALCONERA EN ESQUINA ENTRANTE 2+2 HOJAS

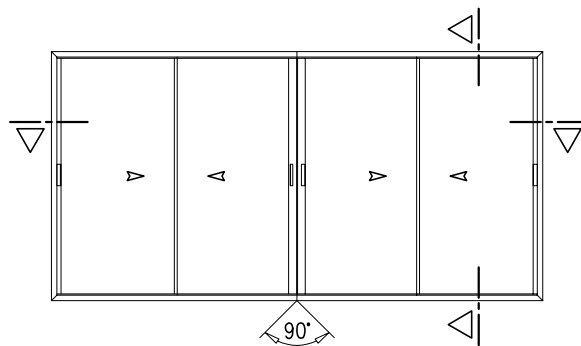

PERFILES

REFERENCIA	DENOMINACION	MARCO INFERIOR VISTO		MARCO INFERIOR OCULTO TAPAS ALUMINIO		MARCO INFERIOR OCULTO PISO CORRIDO	
		CANT.	CORTE	CANT.	CORTE	CANT.	CORTE
R-941	MARCO +38.PP.020	4		4		4	
		2		2		2	
R-943	HOJA LATERAL	4	H-115	4	H-138	4	H-158
R-945	HOJA SUP/INF	8	(L/2)-76	8	(L/2)-76	8	(L/2)-76
16.349	SUPLEMENT. HOJA			4	(L/2)-76		
16.651	SUPLEMENT. HOJA					4	(L/2)-76
16.347	HOJA DE CIERRE	4	H-115	4	H-138	4	H-158
R-947	HOJA ESQUINA	1	H-69	1	H-94	1	H-114
16.358	CIERRE ESQUINA	1	H-69	1	H-94	1	H-114
16.341	CIERRE LATERAL	2	H-37	2	H-74	2	H-94
16.342	TAPA CANAL	4	(L/2)-103	2	(L/2)-103	2	(L/2)-103
		4	(L/2)-26	2	(L/2)-26	2	(L/2)-26
		2	H-72	2	H-72	2	H-72
16.343	TAPA MARCO	2	H-36	2	H-36	2	H-36
16.344*	TAPA CENTRAL			2	L-82		
16.345*	TAPA LATERAL			2	L-40		
				2	L-150		
16.652*	TAPA CENTRAL					2	L-80
16.653*	TAPA LATERAL					2	L-40
						2	L-149
R-948	SOLERA	2	L-2	2	L-2	2	L-2
15.686	TAPA CANALETA	2	L-172	2	L-172		
16.351	CANALETA DRENAJE	2	L-175	2	L-175	2	L-175
16.348	REFUERZO TIRADOR	4	H-119	2	H-142	2	H-162
10.466	TAPETA TIRADOR	4	H-119	2	H-142	2	H-162

ACCESORIOS

REFERENCIA	DENOMINACION	M.INF. VISTO	M.INF. OCULTO TAPAS ALUMINIO	M.INF. OCULTO PISO CORRIDO
		UNIDADES	UNIDADES	UNIDADES
04.AC.848	Cremona 3 puntos	3	3	3
04.AC.055.M	Cerradero	9	9	9
04.AC.056	Embellecedor Cerradero	9	9	9
04.AC.853	Manilla Dcha.	1	1	1
04.AC.844	Manilla Izda.	2	2	2
04.AC.845	Tirador	1	1	1
04.AC.067	Kit Hoja Lateral	4	4	4
04.AC.068	Kit Hoja Central	4		
04.AC.069	Kit H.Central M.Inf. Oculto Tapas Aluminio		4	
04.AC.070	Kit H.Central M.Inf. Oculto Piso Corrido			4
04.AC.078	Tapa H.Lateral M.Inf. Oculto Tapas Aluminio		4	
04.AC.079	Tapa H.Lateral M.Inf. Oculto Piso Corrido			4
04.AC.071	Kit Cortavientos	2		
04.AC.080	Kit Cortavientos Marco Inferior Oculto		2	2
04.AC.075	Taco Estanq. M.Inf. Oculto Tapas Aluminio		2	
04.AC.081	Taco Estanq. M.Inf. Oculto Piso Corrido			2
04.AC.077	Kit Cierre Esquina Marco Inf. Oculto		1	1
04.ES.083	Escuadra Marco	8	8	8
04.ES.084	Escuadra Marco Esquina	4	4	4
04.AC.F10	Felpudo Marco	8L+4H	4L+4H	12L+4H
04.AC.F09	Felpudo Suplementos Hoja 16.349 y 16.651		4L	4L
04.JU.004.D	Junta Cierre Lateral	4H	4H	4H
04.JU.004.E	Junta Cierre Esquina	2H	2H	2H
04.JU.062	Junta Cruce Central	4H	4H	4H
04.JU.067	Junta Cruce Central	4H	4H	4H
04.JU.068	Junta Tapacanal Marco	4L	4L	4L
04.JU.069	Junta Carril	x8 L-300	L-300	L-300
04.AC.R150	Carril Acero Inox.	x8 L-300	L-300	L-300
04.AC.R151	Rodamiento	8	8	8
04.AC.R153	Kit Angulo Rod. M.Inf. Oculto Tapas Aluminio		4	
04.AC.R154	Kit Angulo Rod. M.Inf. Oculto Piso Corrido			4
04.TA.069	Juego Tapas Tirador	4	4	4
04.TA.070	Tapa para Canaleta	2	2	2
04.TA.071	Tapa para Solera	2	2	2
04.AC.073	Calzo Vidrio	Según dimensiones de Vidrio		

*Se indica la longitud total necesaria. Las tapas se colocan en tramos para permitir el montaje.

El perfil 16.651 se coloca deslizado en la hoja inferior en 2 trozos, para permitir sacar la hoja del marco en caso de necesidad una vez colocado el piso.

ACRISTALAMIENTO

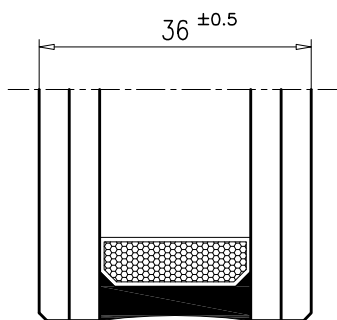

- La fabricación del vidrio se debe de realizar con silicona compatible con la silicona de sellado DOWSIL 776 InstantFix, nunca con polisulfuro o poliuretanos.
- Utilizar Intercalario de 6,5mm de color negro.
- Vidrios siempre con canto pulido.
- Es imprescindible eliminar de los cantos de los vidrios los sobrantes del sellado de fabricación.
- Tolerancia en alineamiento entre las hojas de vidrio $\pm 0.5\text{mm}$.
- Tolerancia en las dimensiones totales del vidrio $+1/-3\text{mm}$.

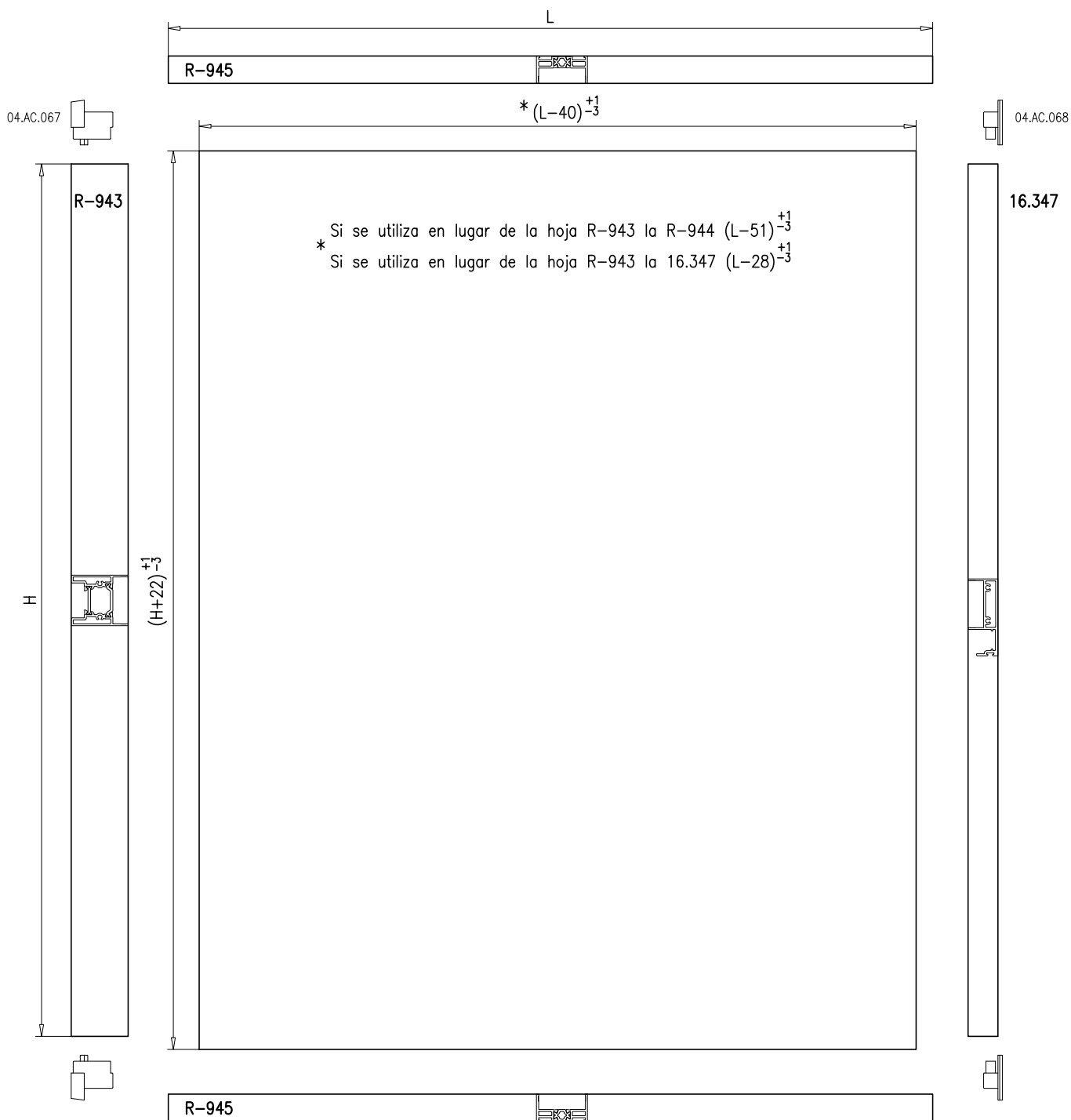

ACRISTALAMIENTO, Colocación de calzos y Sellado

Suplemento

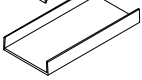

Calzo

- El Calzo de Acristamiento 04.AC.073 esta formado por un calzo en "U" y un suplemento que solo es necesario en caso de que el vidrio no tenga la medida nominal pero este dentro de las tolerancias de fabricación +1/-3mm.
- Cuando el vidrio tiene la medida nominal o 1mm más sólo se coloca el calzo en "U"
- Si el vidrio tiene 1mm menos de la medida nominal se coloca sobre los calzos en "U" el suplemento a uno de los lados.
- Si el vidrio tiene 2 ó 3mm menos de la medida nominal se coloca sobre los calzos en "U" el suplemento a ambos lados.

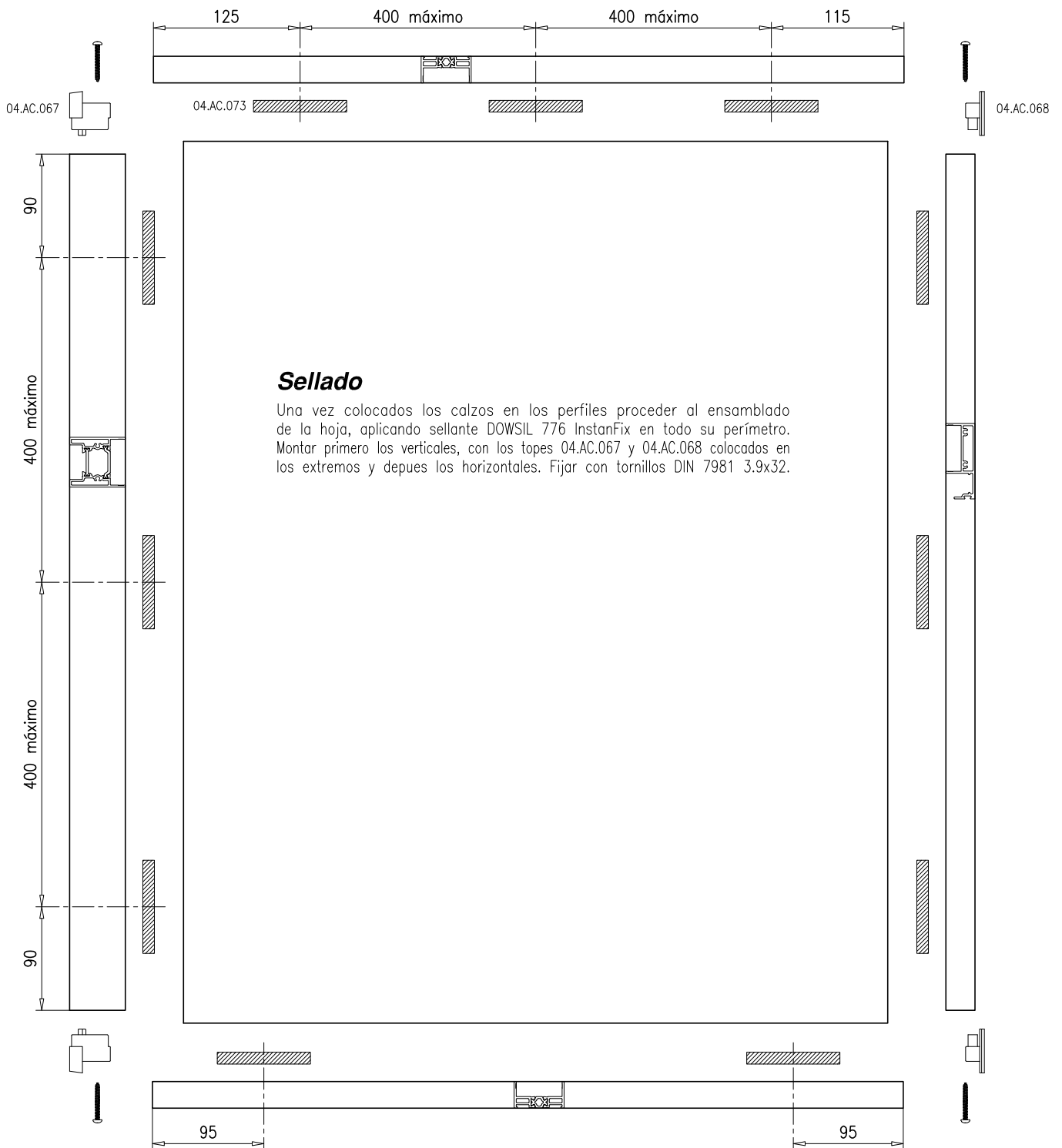

Sellado

Una vez colocados los calzos en los perfiles proceder al ensamblado de la hoja, aplicando sellante DOWSIL 776 InstanFix en todo su perímetro. Montar primero los verticales, con los topes 04.AC.067 y 04.AC.068 colocados en los extremos y después los horizontales. Fijar con tornillos DIN 7981 3.9x32.

ES FUNDAMENTAL LA CORRECTA COLOCACION DE LOS CALZOS INFERIORES PARA QUE EL PESO DE LA HOJA DESCANSE SOBRE LOS RODAMIENTOS.

Mecanizado y Montaje de Cremona de 1 punto 04.AC.846 y Manilla 04.AC.853 ó 04.AC.854

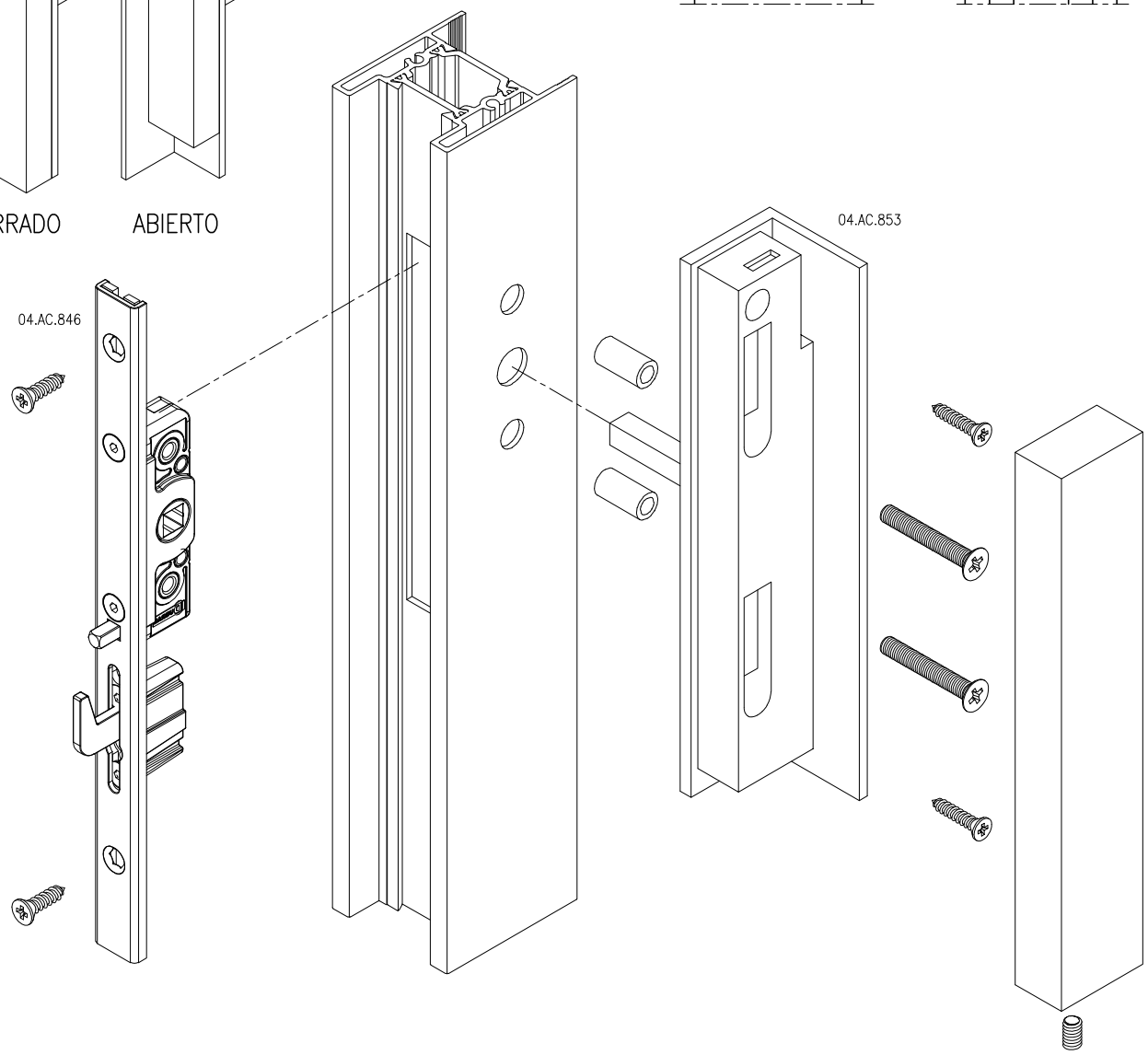
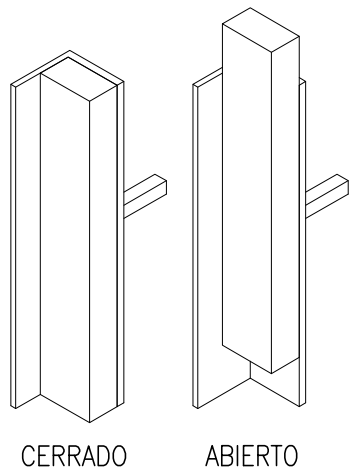
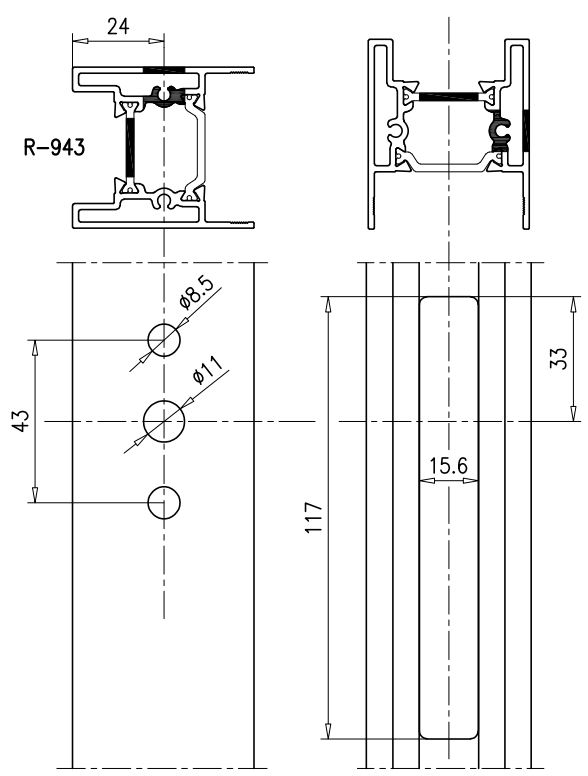
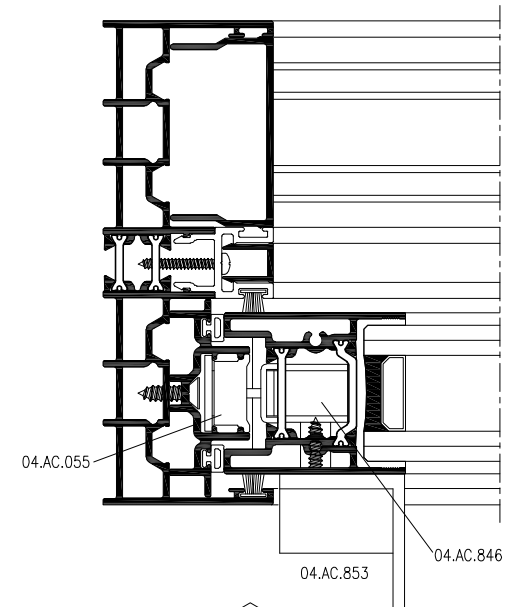

Mecanizado y Montaje de Cremona de 1 punto 04.AC.846 y Manilla 04.AC.843 ó 04.AC.844

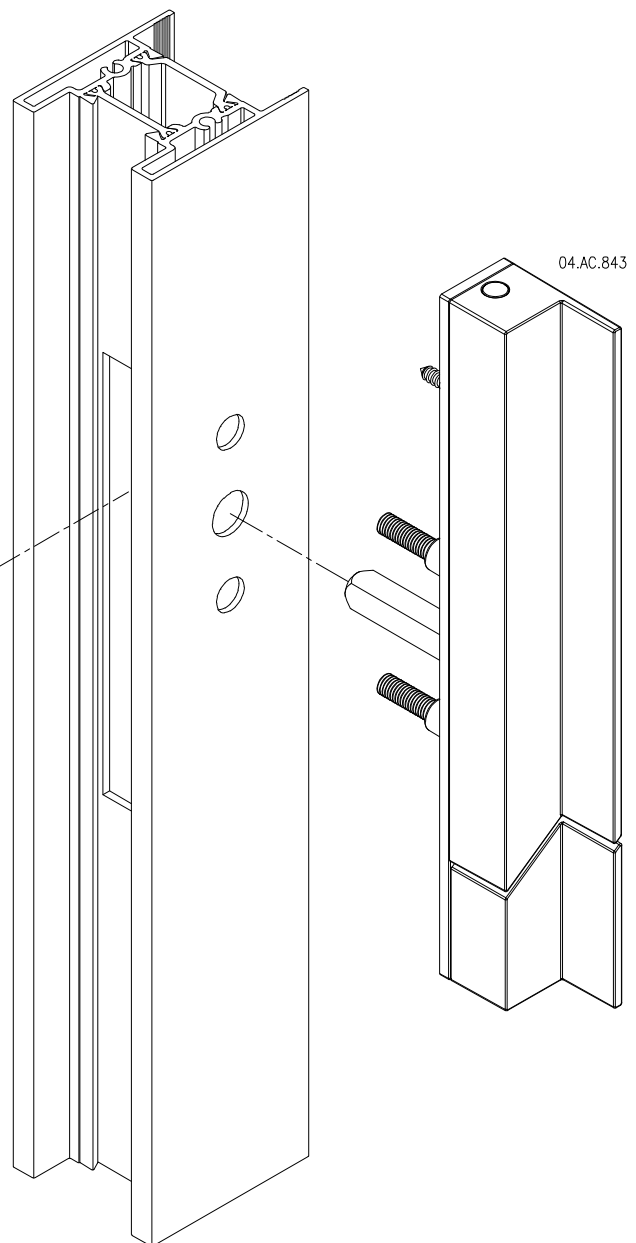
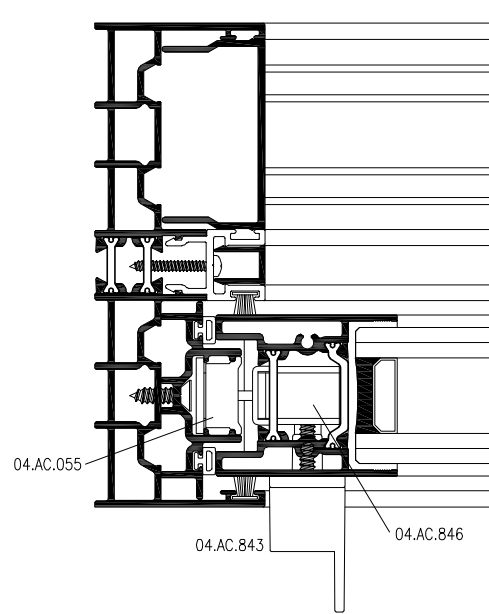
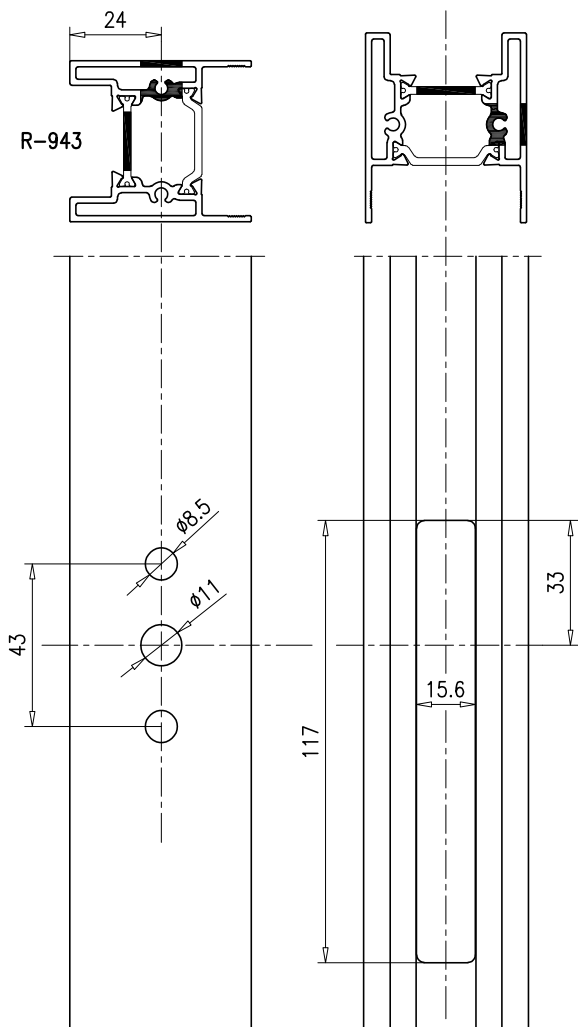

La Cremona se fija a la Hoja con tornillos DIN 7982 3.9x16

la nariz es regulable

Mecanizado y Montaje de Cremona de 1 punto 04.AC.846 y Cierre Embutido 04.AC.827

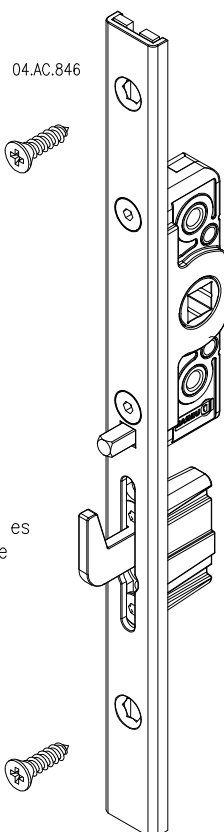
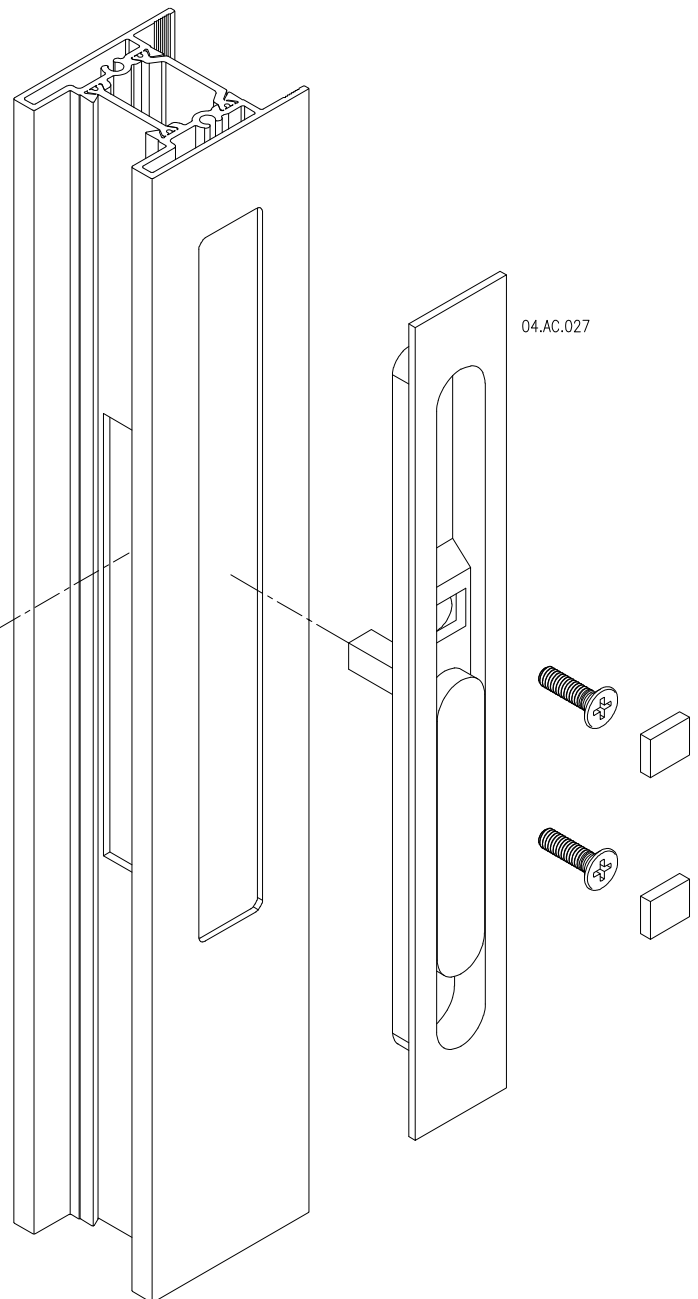
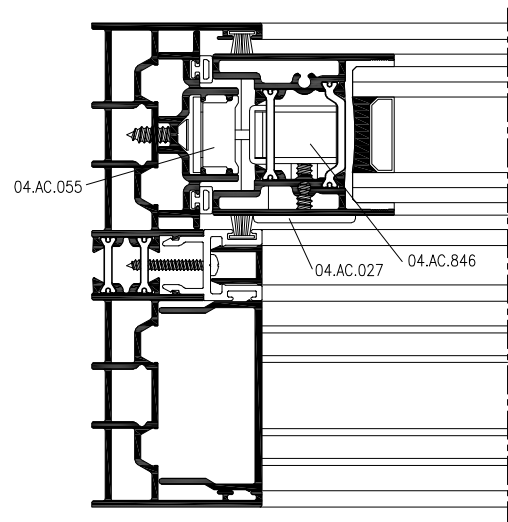
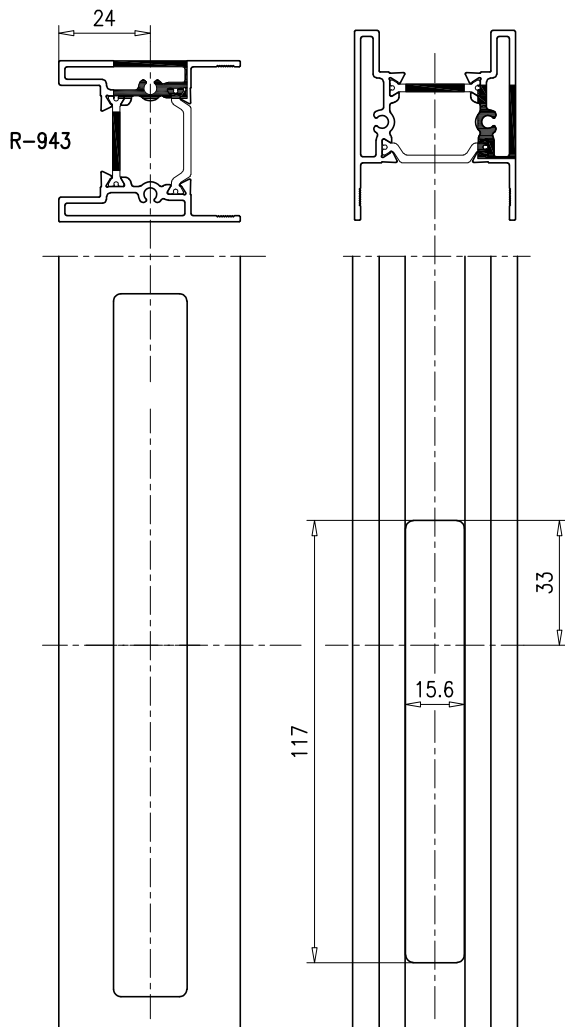

La Cremona se fija a la Hoja con tornillos DIN 7982 3.9x16

la nariz es regulable

Mecanizado y Montaje del Cierrea Central 04.AC.855

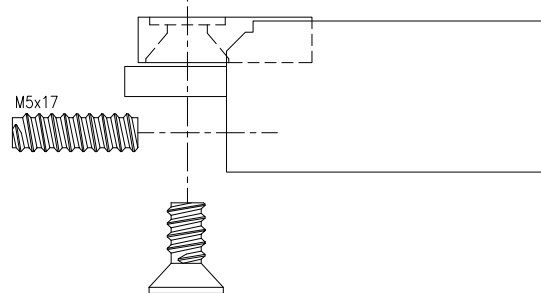
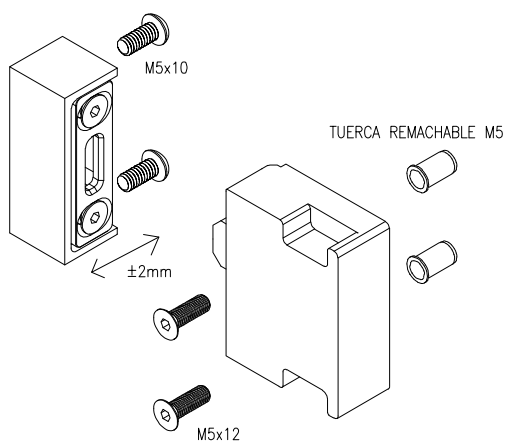
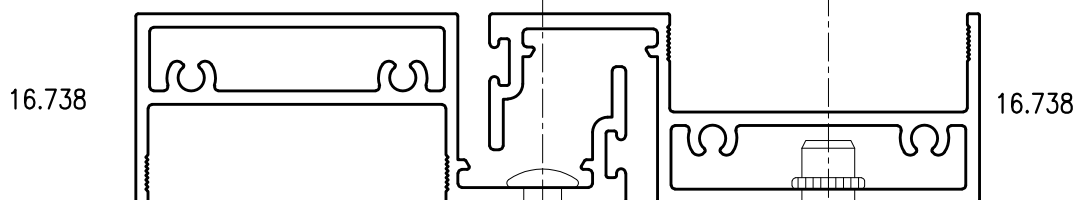
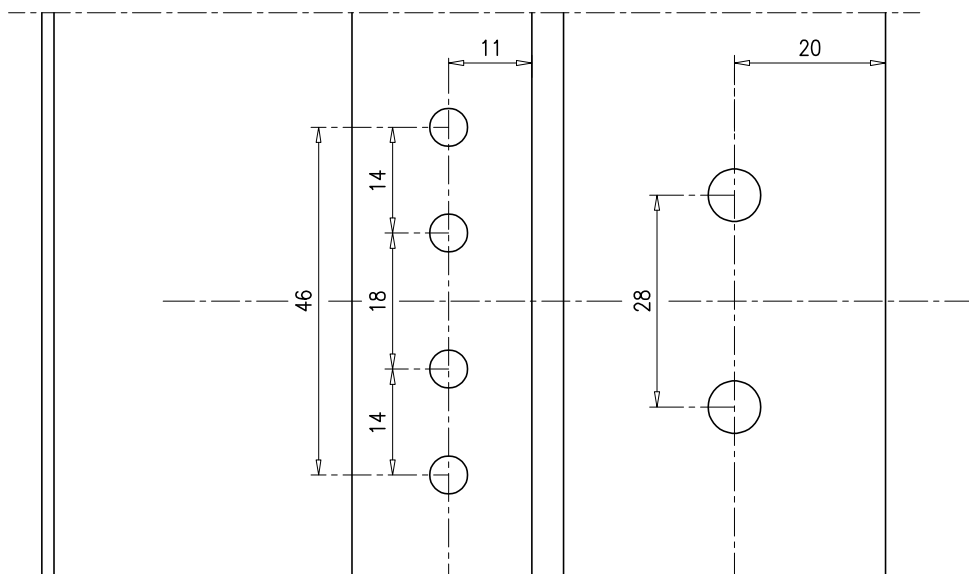

Quitar el espárrago M5x17 para fijar la manilla a la hoja en posición abierta, colocar de nuevo el espárrago para limitar el movimiento de la manilla. La manilla se fija con tornillos M5x15 sobre tuercas previamente remachadas a la hoja.

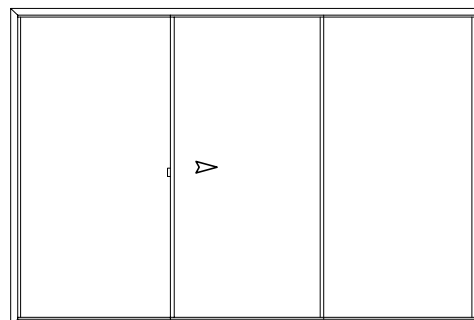
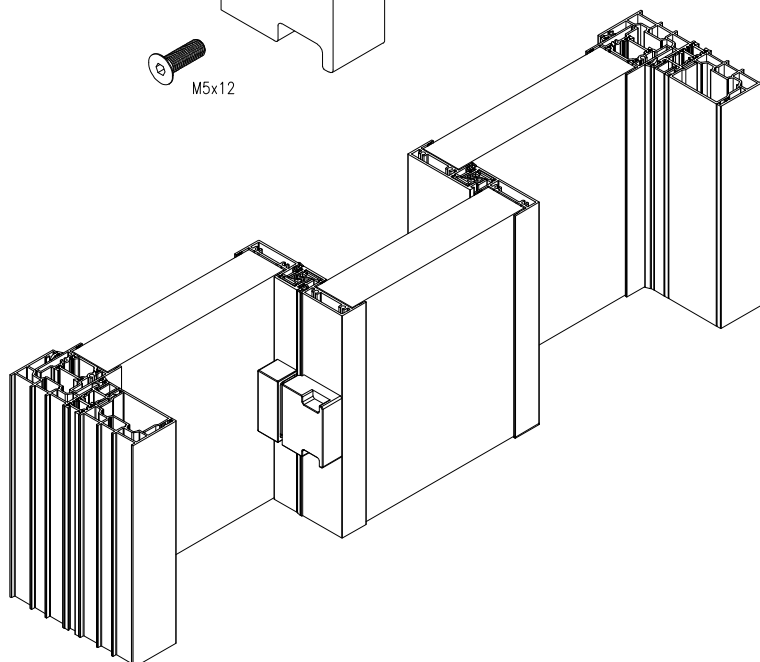

Mecanizado para Cremona de 3 puntos 04.AC.048 y Alargador de Cremona 04.AC.049

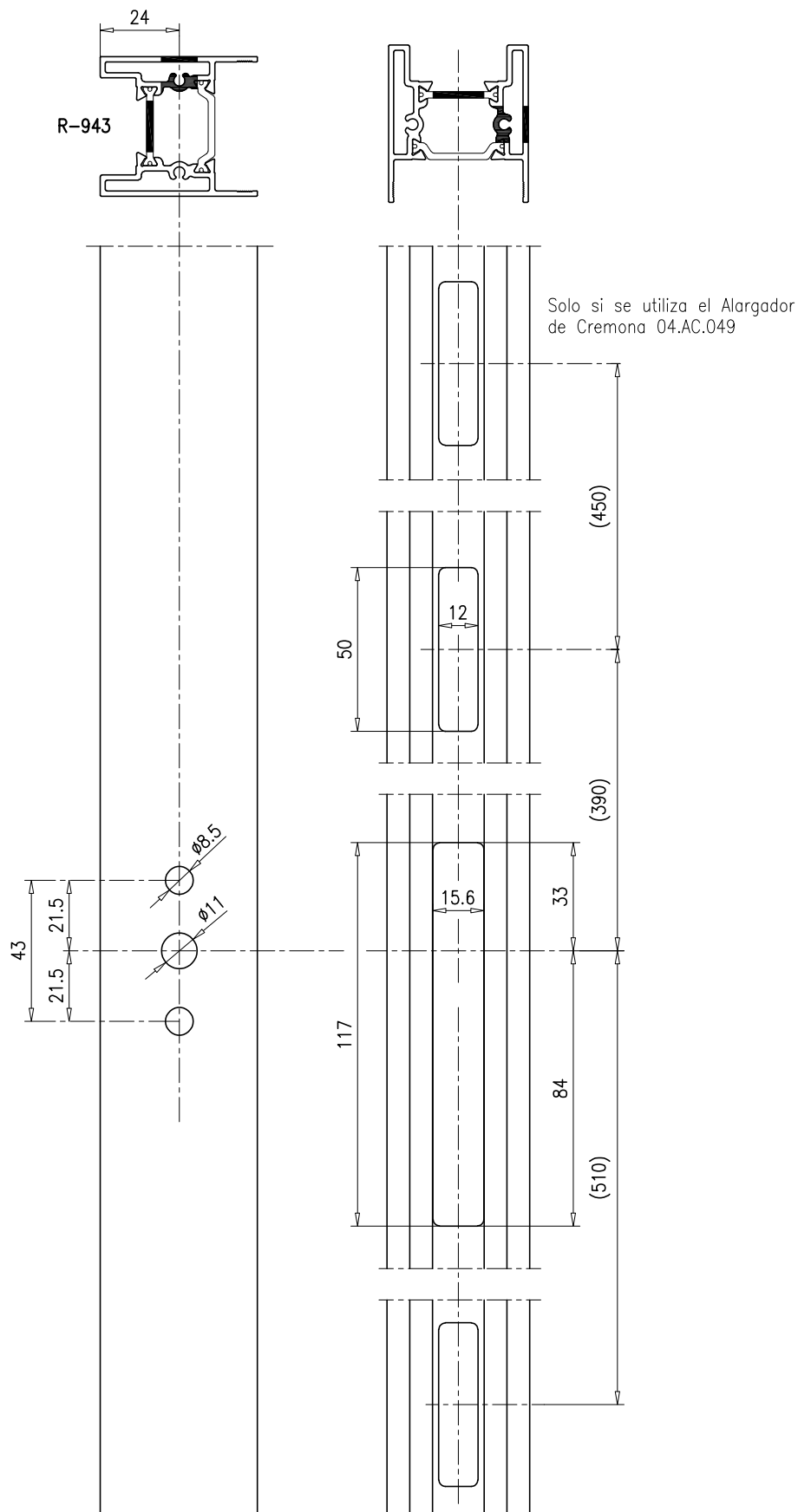

Montaje de Cremona de 3 puntos 04.AC.048

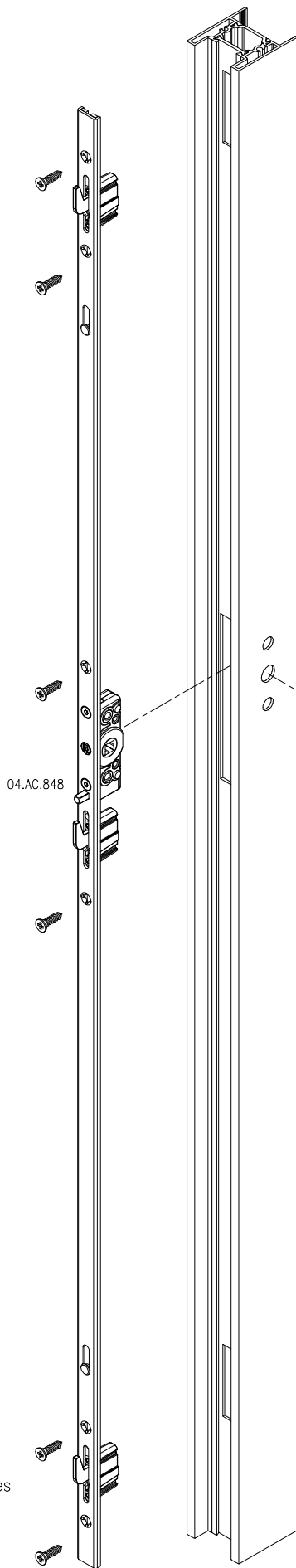
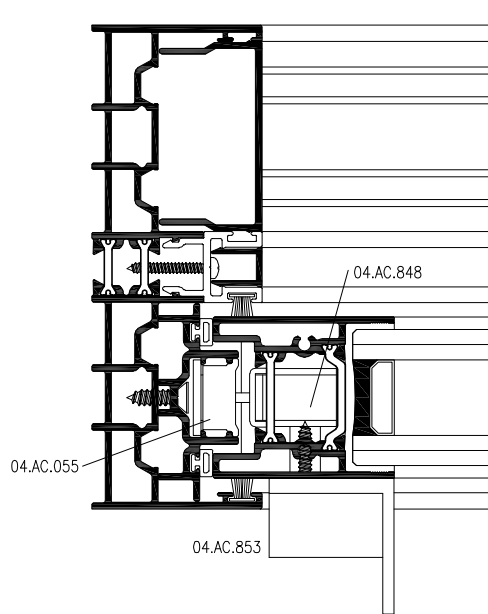

A la cremona de 3 puntos 04.AC.848 se le pueden añadir más puntos de cierre con el prolongador 04.AC.849

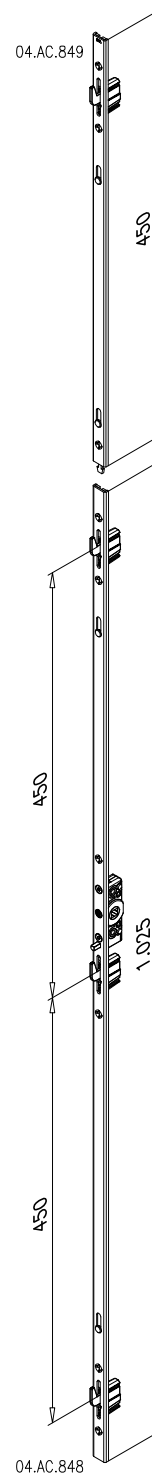

La Cremona se fija a la Hoja con tornillos DIN 7982 3.9x16

la nariz es regulable

Mecanizado para Cremona de 3 puntos con Llave 04.AC.050

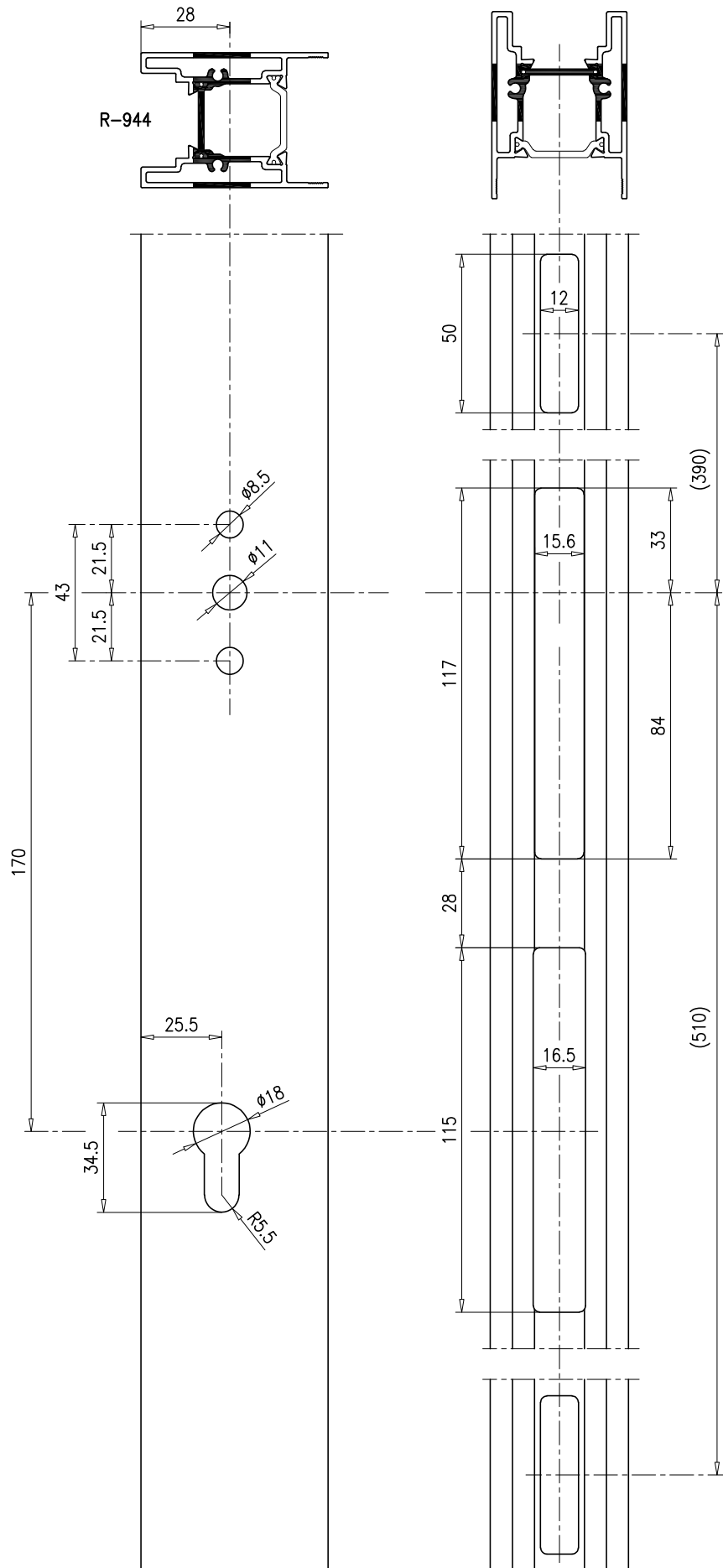

Montaje de Cremona de 3 puntos con Llave 04.AC.050

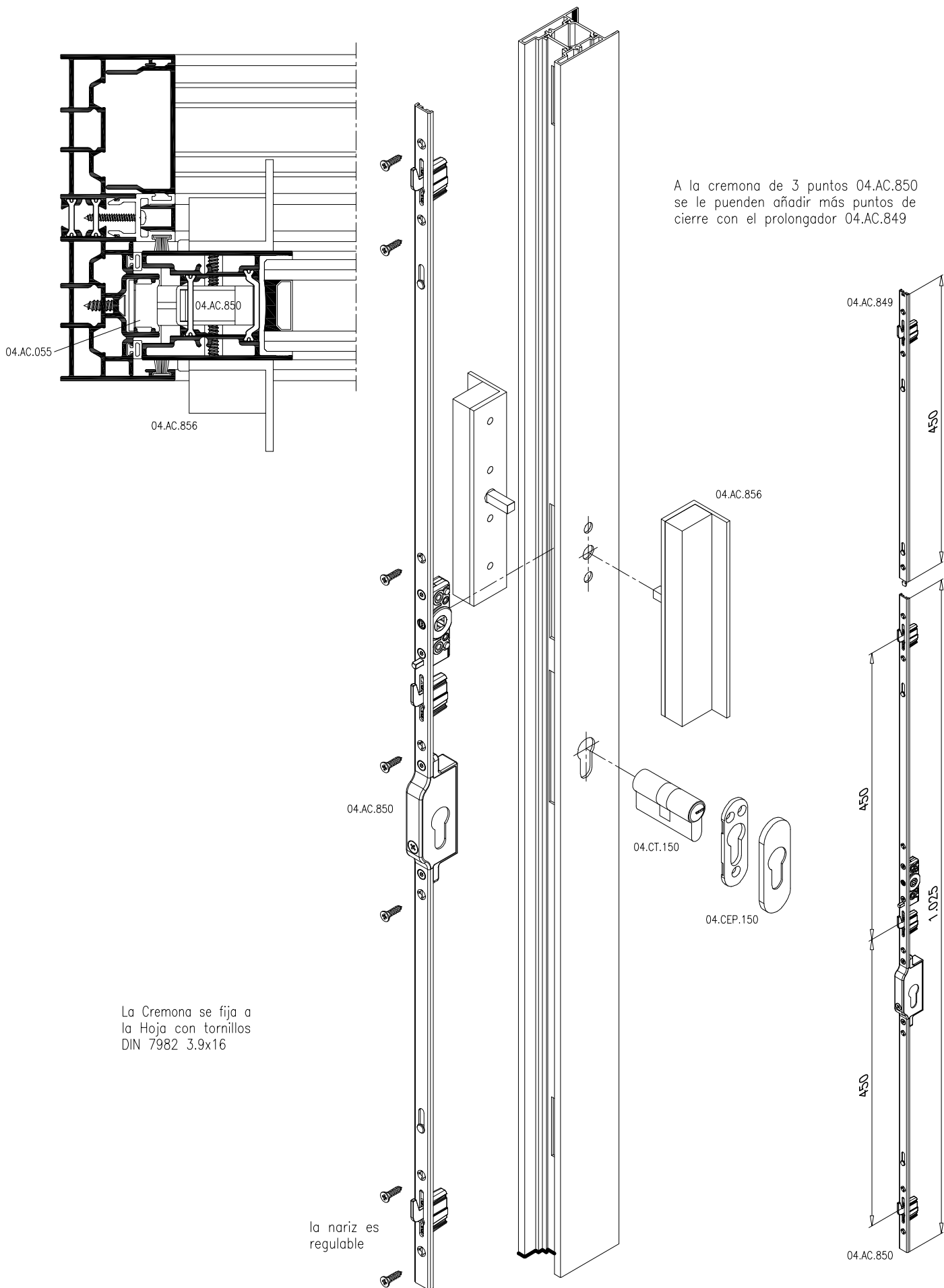

Ensamblado de Hoja Lateral

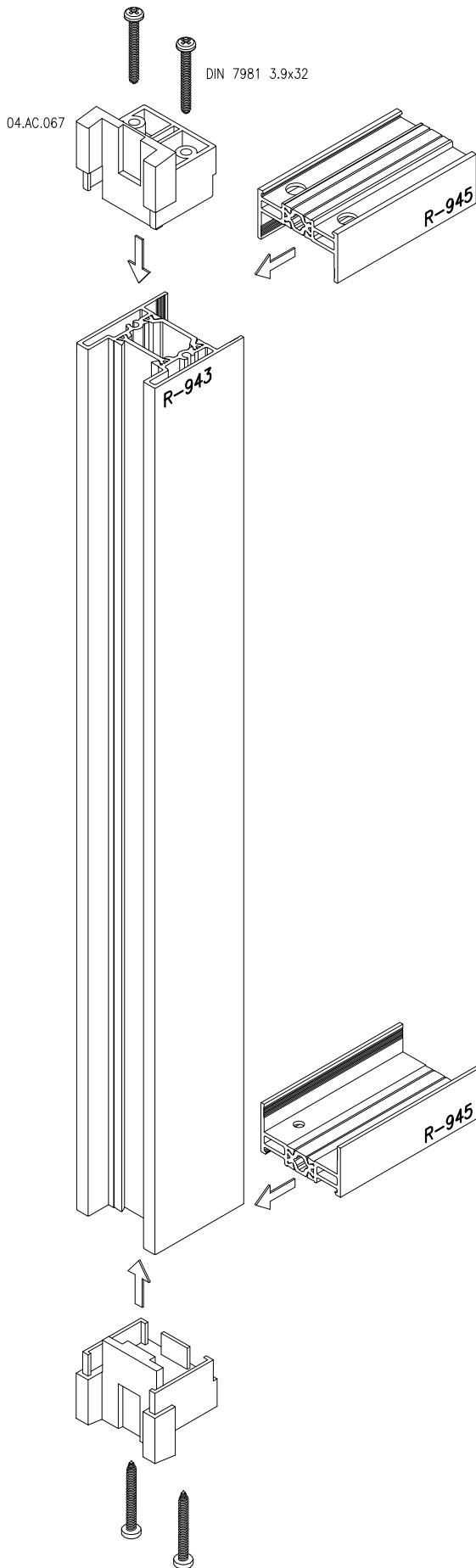

El tope superior se fija en su posición una vez colocada la hoja en el marco

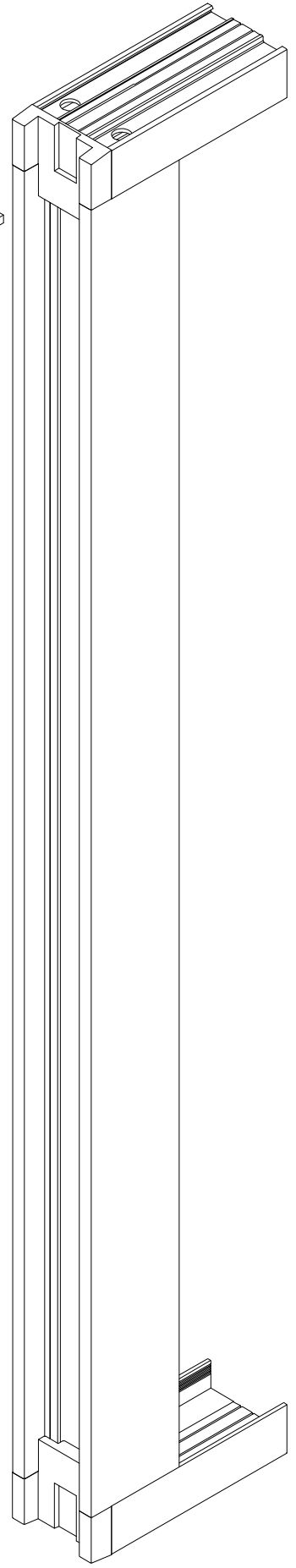
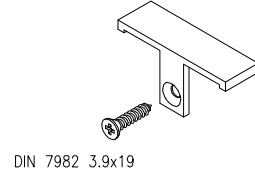

Ensamblado de Hoja Central

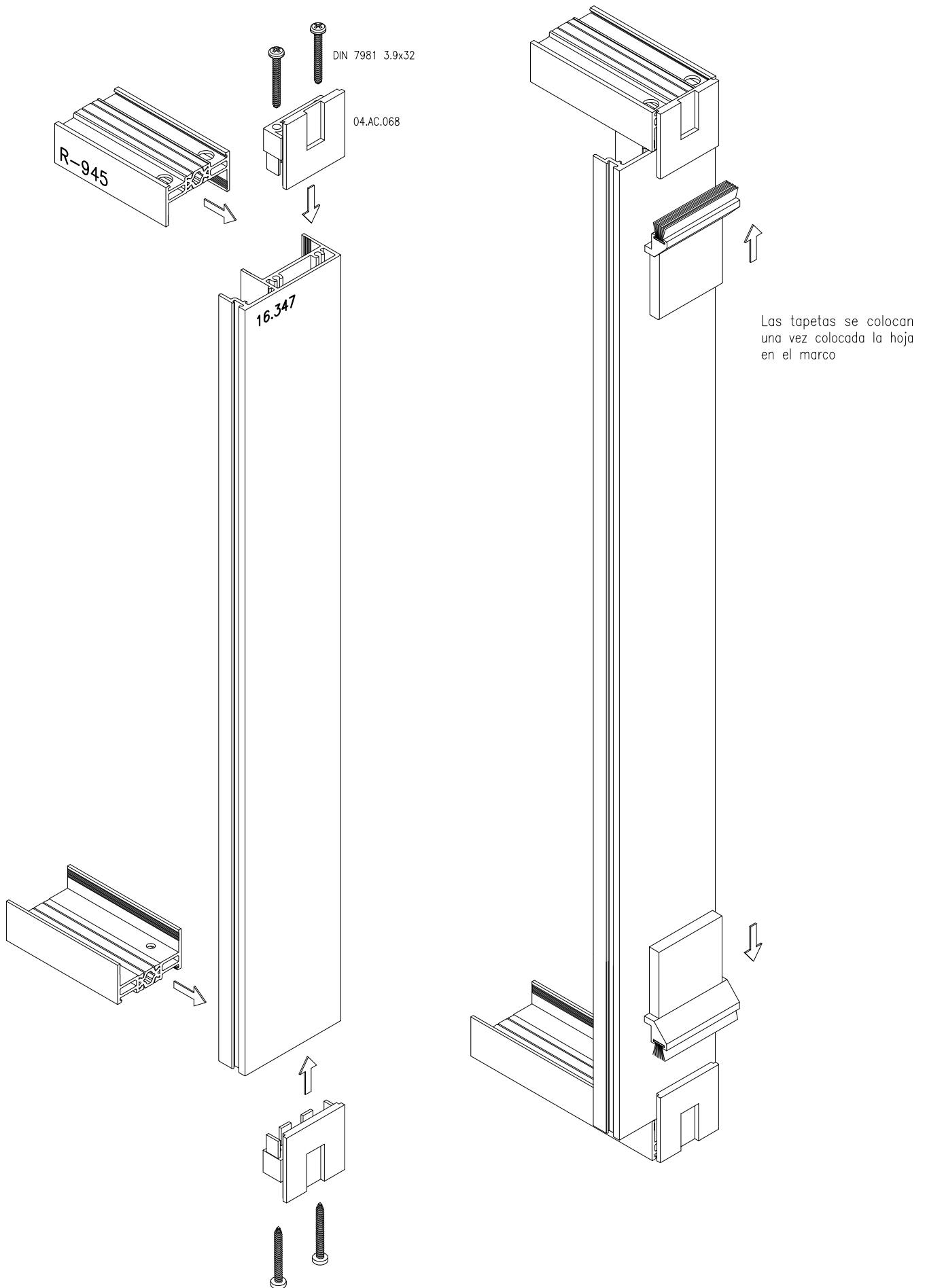

Ensamblado de Hoja Lateral para Marco Inferior Oculto con Tapas de Aluminio o Piso Corrido

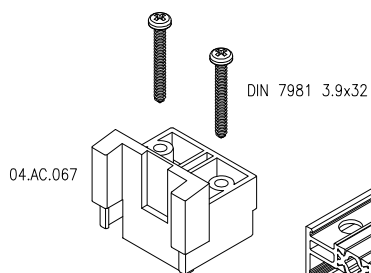

El tope superior se fija en su posición una vez colocada la hoja en el marco

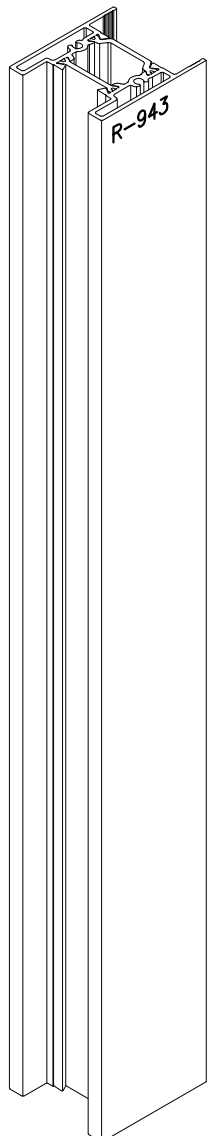
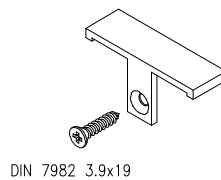
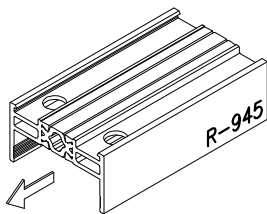

Para Piso Corrido se utiliza el perfil de suplemento de hoja 16.651 (siempre en acabado anodizado), en puertas de 2 Hojas se coloca en 2 trozos por hoja, lo que permite su desmontaje para sacar la hoja del marco en caso de necesidad una vez que se ha colocado el piso.

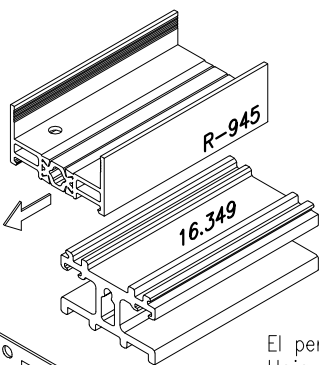

El perfil de suplemento de Hoja 16.349, siempre en acabado anodizado, se monta deslizado en la Hoja Inferior R-945

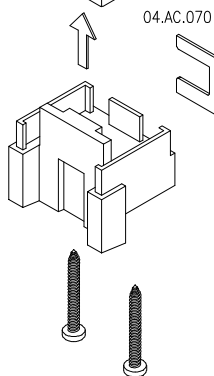

En caso de Piso Corrido sustituir por el perfil 16.651 y la tapa 04.AC.079

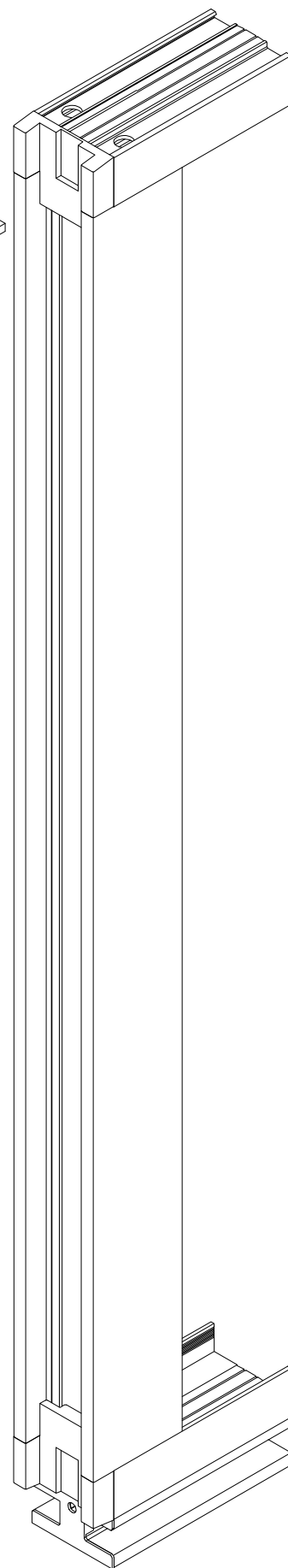

Ensamblado de Hoja Central para Marco Inferior Oculto con Tapas de Aluminio o Piso Corrido

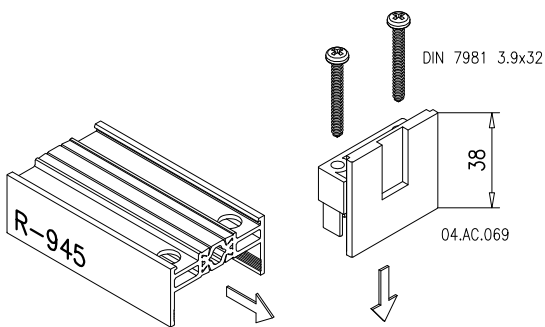

Para Marco Inferior Oculto con Tapas de Aluminio utilizar el Kit 04.AC.069 con Piso Corrido utilizar el 04.AC.078

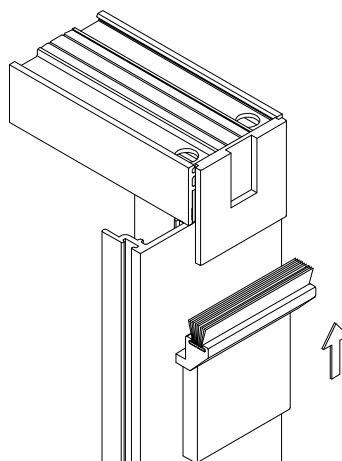
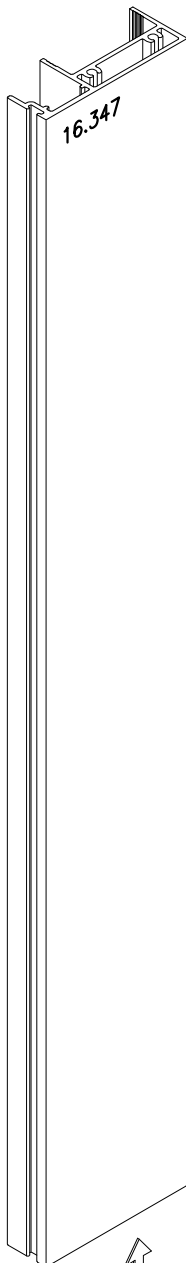

Las tapetas se colocan una vez colocada la hoja en el marco

Para Piso Corrido se utiliza el perfil de suplemento de hoja 16.651 (siempre en acabado anodizado), en puertas de 2 Hojas se coloca en 2 trozos por hoja, lo que permite su desmontaje para sacar la hoja del marco en caso de necesidad una vez que se ha colocado el piso.

En caso de Piso Corrido sustituir por el perfil 16.651

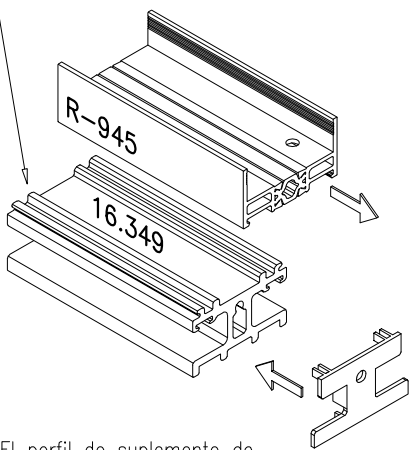

El perfil de suplemento de Hoja 16.349, siempre en acabado anodizado, se monta deslizado en la Hoja Inferior R-945

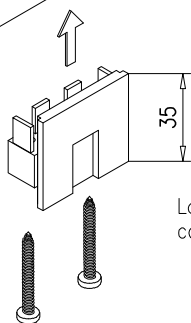

La pieza más pequeña se coloca en la parte inferior

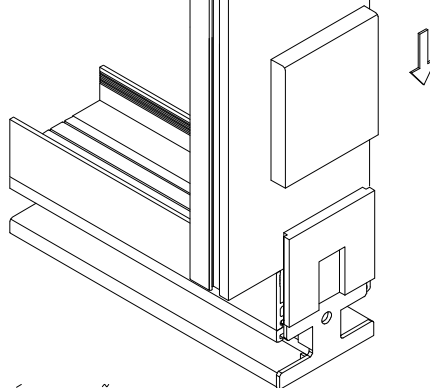

Montaje de Perfil 4 Hojas

El perfil de 4 Hojas R-946 se fija a la Hoja con tornillos DIN 7982 2.9x9 una vez instalada esta en el Marco y colocado el tope superior.

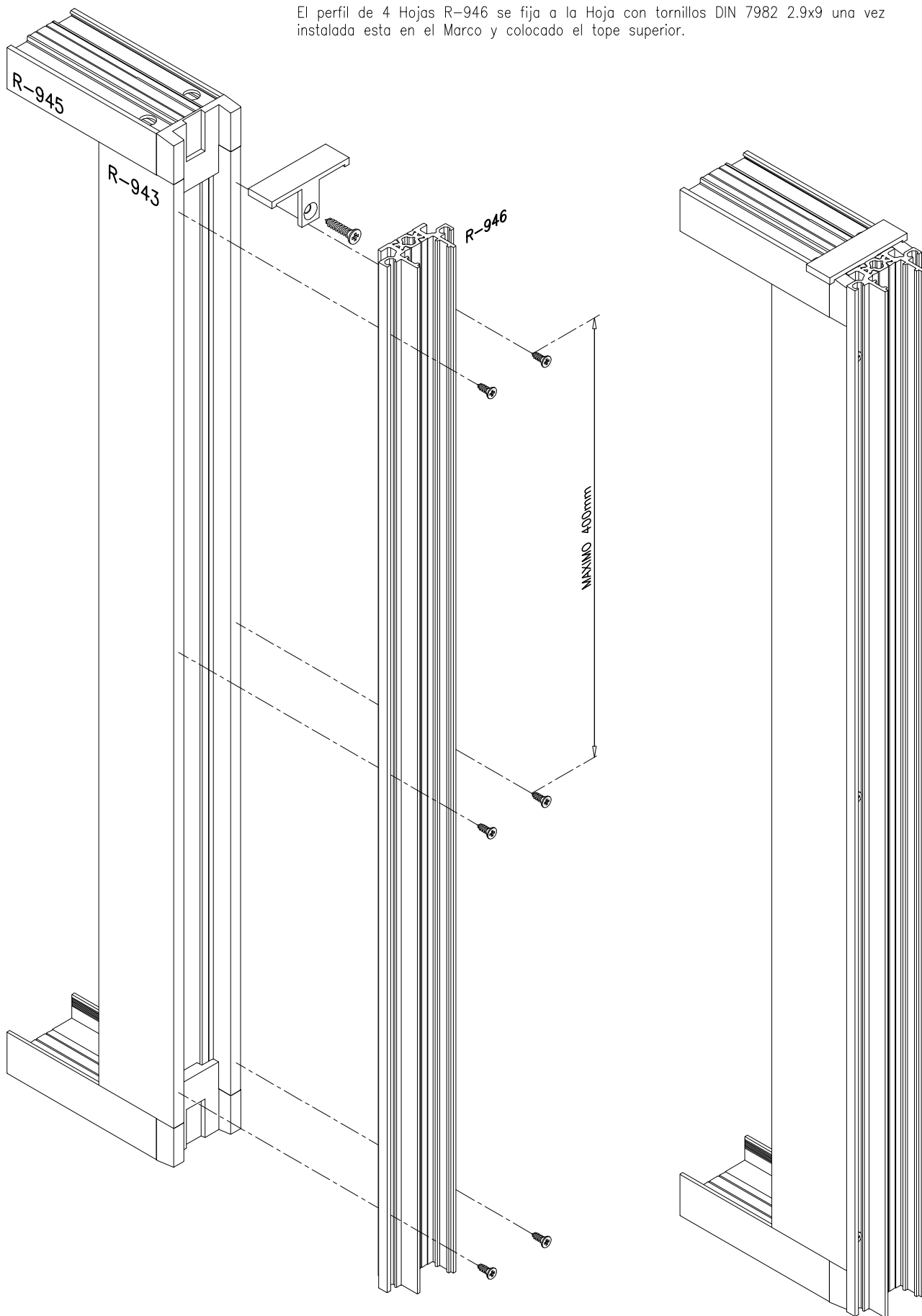

Montaje de Perfil 4 Hojas para Marco Inferior Oculto con Tapas de Aluminio o Piso Corrido

El perfil de 4 Hojas R-946 se fija a la Hoja con tornillos DIN 7982 2.9x9 una vez instalada esta en el Marco y colocado el tope superior.

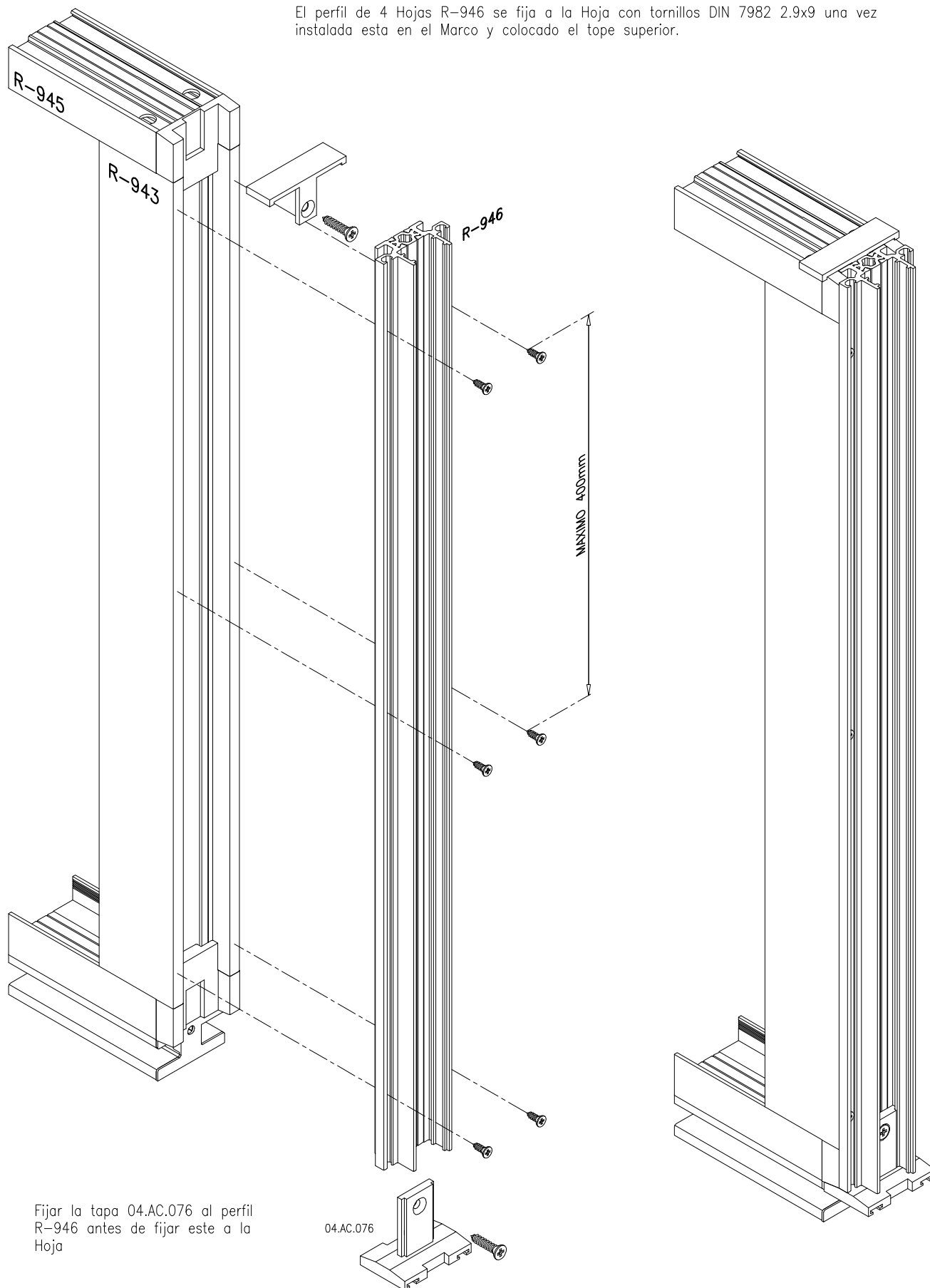

Fijar la tapa 04.AC.076 al perfil R-946 antes de fijar este a la Hoja

04.AC.076

Montaje de Perfil de Esquina

El perfil de Esquina R-947 se fija a la Hoja con tornillos DIN 7981 4.2x45 una vez instalada esta en el Marco y colocado el tope superior.

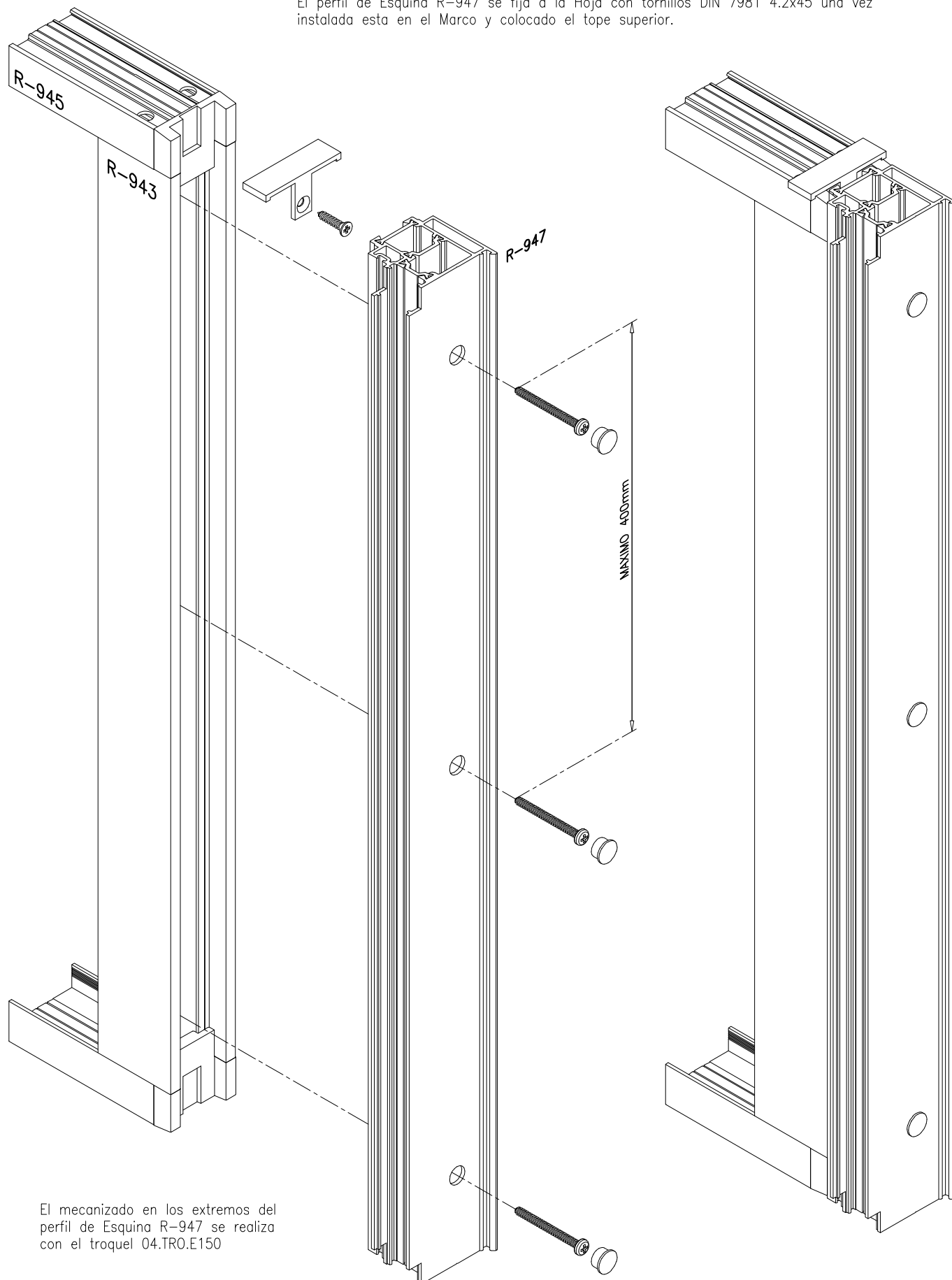

El mecanizado en los extremos del perfil de Esquina R-947 se realiza con el troquel 04.TRO.E150

Montaje de Perfil de Esquina para Marco Inferor Oculto con Tapas de Aluminio o Piso Corrido

El perfil de Esquina R-947 se fija a la Hoja con tornillos DIN 7981 4.2x45 una vez instalada esta en el Marco y colocado el tope superior.

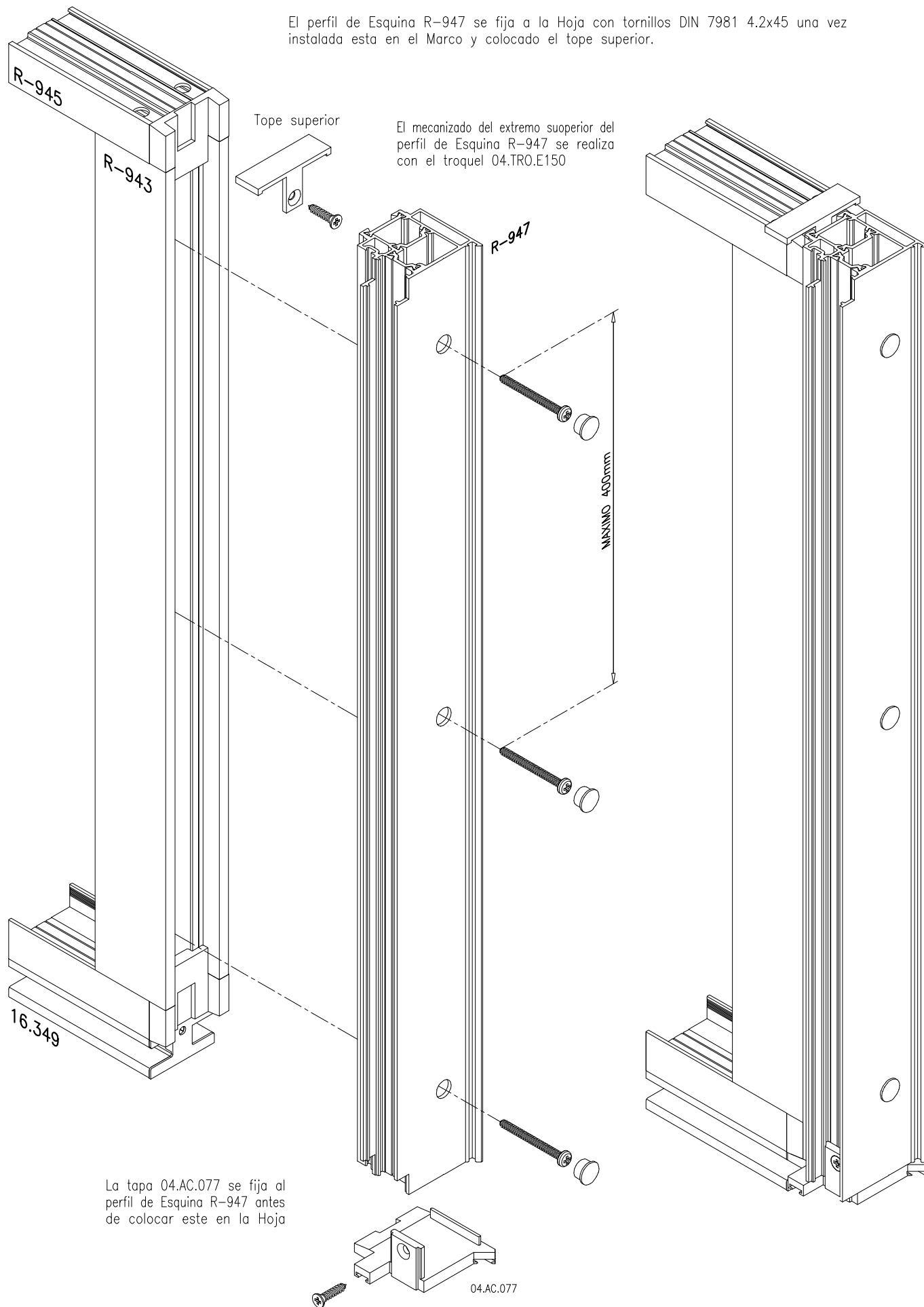

El mecanizado del extremo superior del perfil de Esquina R-947 se realiza con el troquel 04.TRO.E150

La tapa 04.AC.077 se fija al perfil de Esquina R-947 antes de colocar este en la Hoja

COLOCACION DE CARRILES EN MARCO INFERIOR Y FELPUDOS EN MARCO INFERIOR Y SUPERIOR, 2 Hojas en Marco de 2 Carriles

El Perfil de Cierre 16.341 con las juntas 04.JU.004.D se fija a los Marcos Laterales antes de ensamblar el Marco.

ATENCIÓN: El perfil de Cierre 16.341 no es simétrico, tiene posición fija.

El Felpudo 04.AC.F10 se Monta en el Marco antes de su ensamblado en el lado donde quedará la Hoja cerrada y se fija con cianoacrilato.

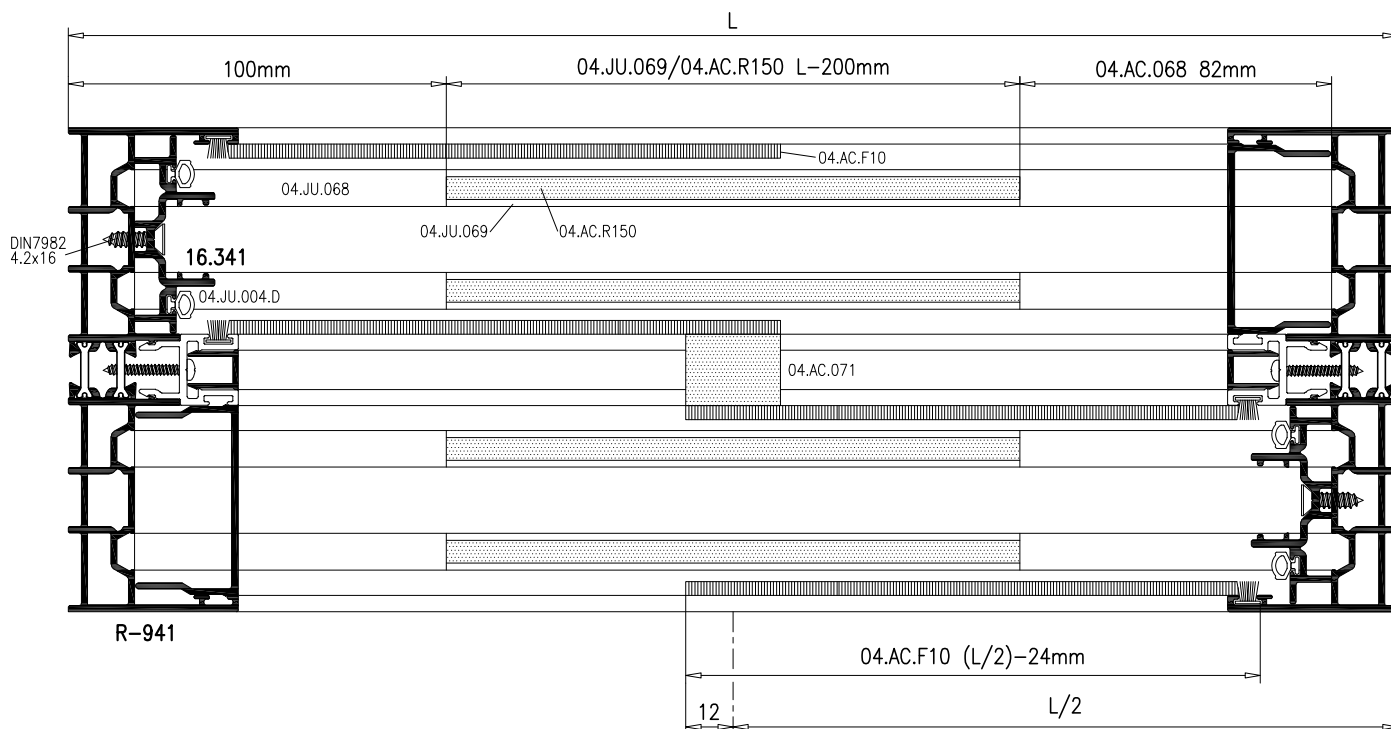

COLOCACION DE CORTAVIENTOS (INFERIOR Y SUPERIOR)

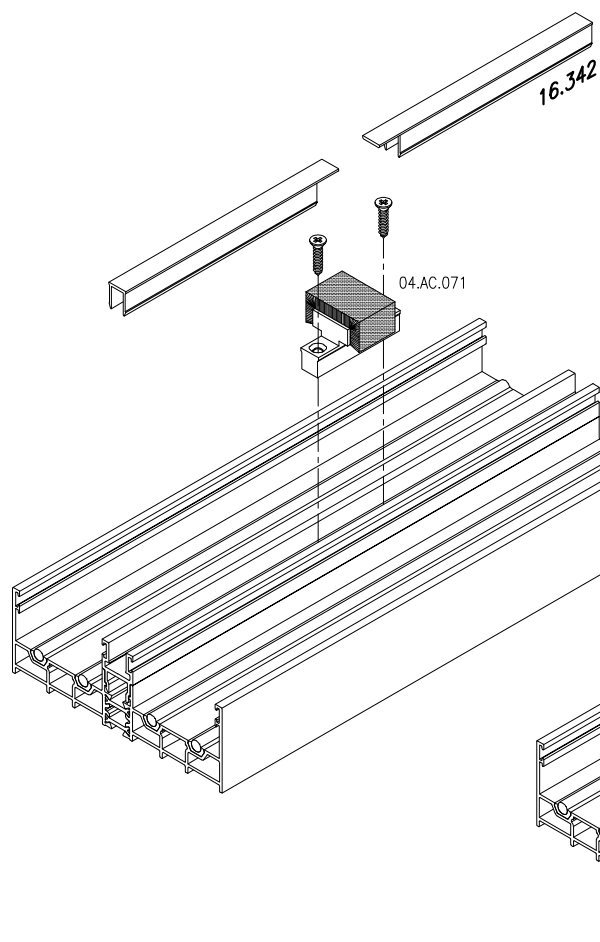

Una vez fijados los cortavientos superior e inferior en su posición se clipan las tapetas 16.342, el mecanizado de estas se realiza con el troquel 04.TRO.E150

Si sólo se puede acceder por un lado del Marco a instalar las hojas, primero se colocan estas en el marco y después se colocan los cortavientos y las tapetas.

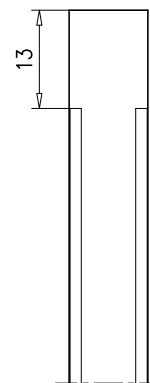
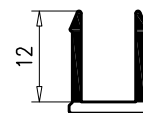

COLOCACION DE CARRILES EN MARCO INFERIOR Y FELPUDOS EN MARCO INFERIOR Y SUPERIOR, 4 Hojas en Marco de 2 Carriles

El Perfil de Cierre 16.341 con las juntas 04.JU.004.D se fija a los Marcos Laterales antes de ensamblar el Marco.

ATENCION: El perfil de Cierre 16.341 no es simétrico, tiene posición fija.

El Felpudo 04.AC.F10 se Monta en el Marco antes de su ensamblado en el lado donde quedará la Hoja cerrada y se fija con cianoacrilato.

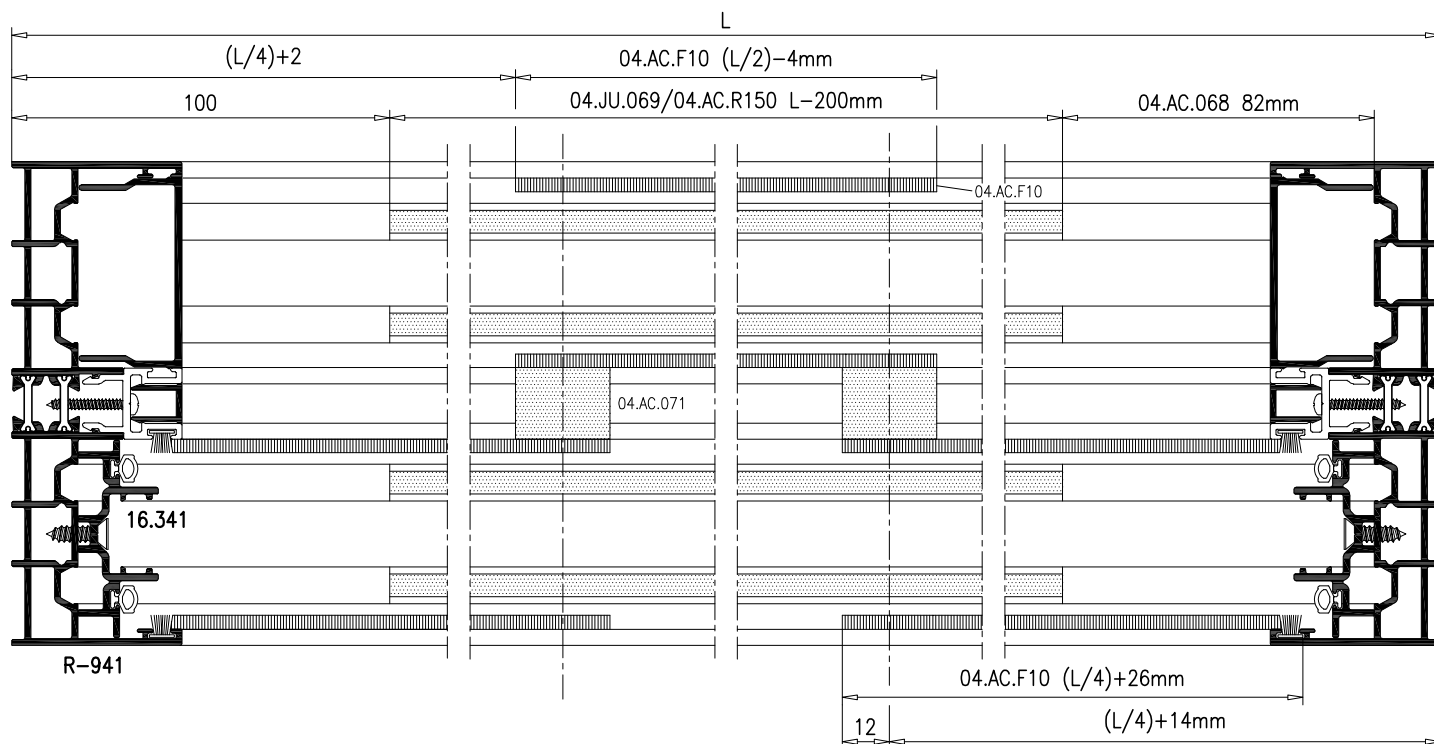

COLOCACION DE CARRILES EN MARCO INFERIOR Y FELPUDOS EN MARCO INFERIOR Y SUPERIOR, 3 Hojas en Marco de 3 Carriles

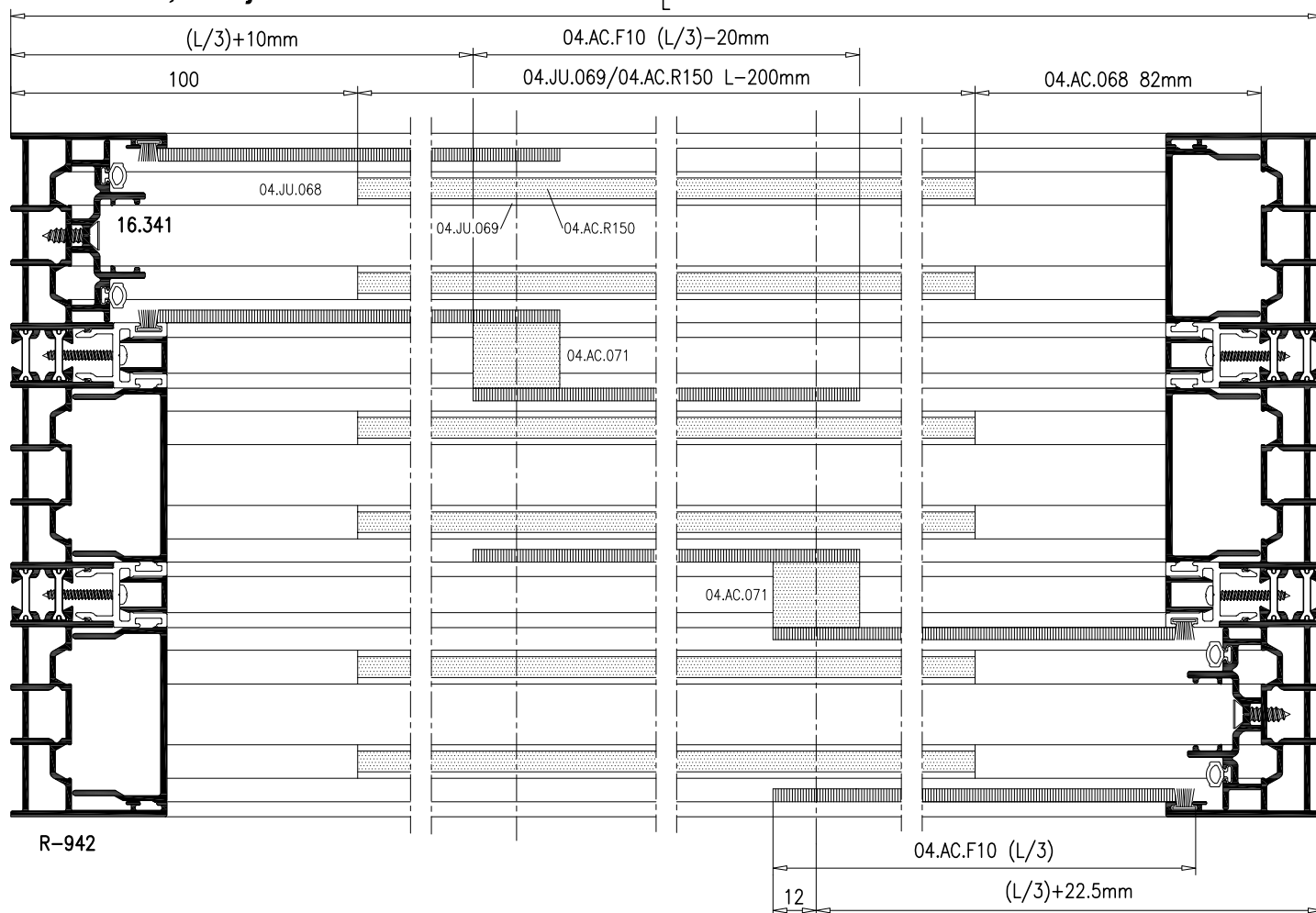

Colocación del Cortavientos Inferior en la Hoja Central para Marco Inferior Oculto con Tapas de Aluminio o Piso Corrido (ref. 04.ac.080)

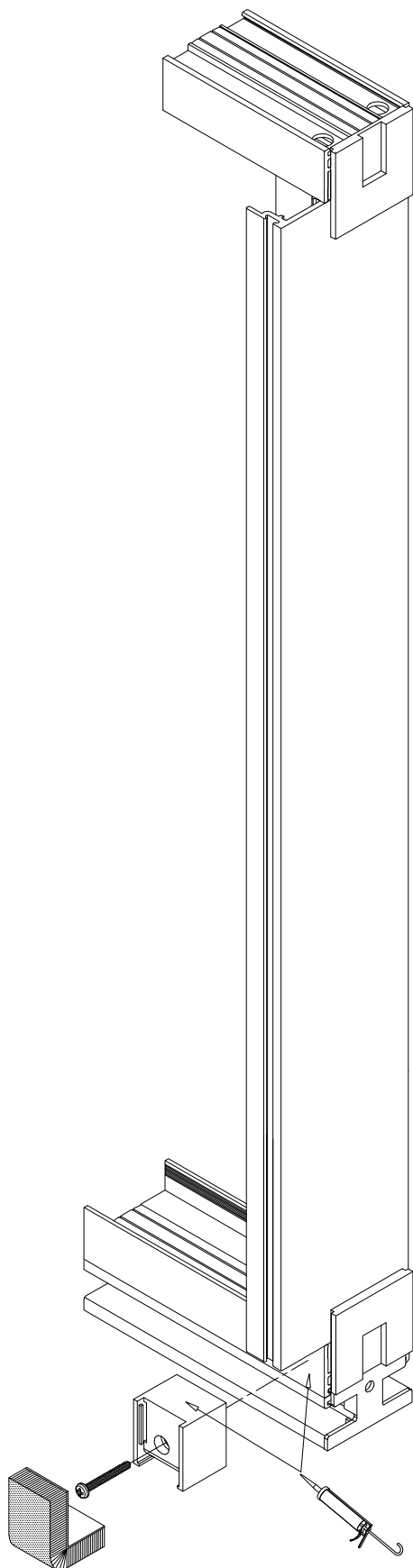

Una vez sellado y atornillado el cortavientos inferior colocar sobre el la felpa

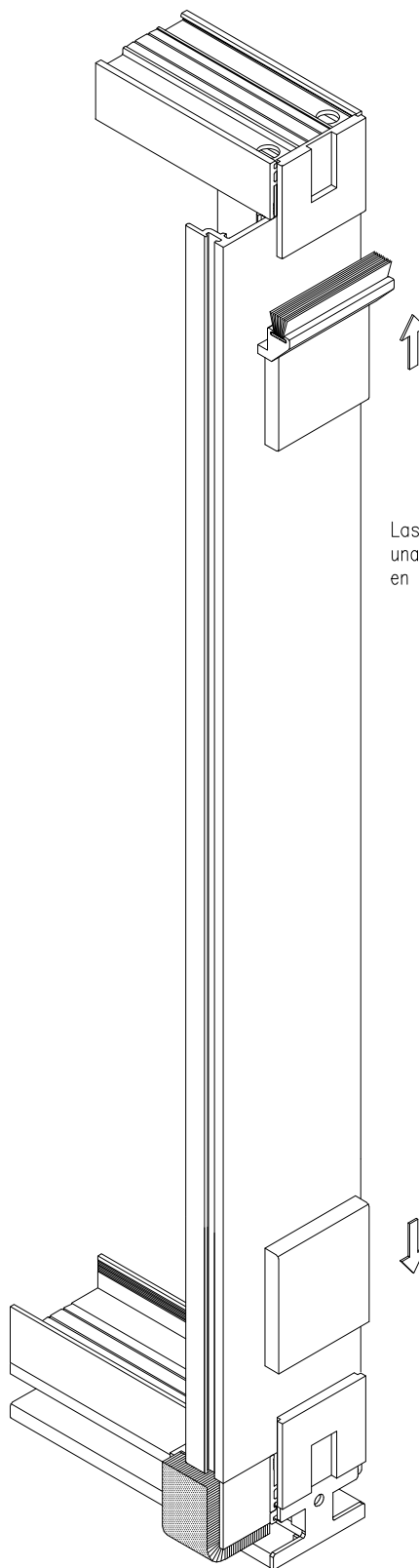

Las tapetas se colocan una vez colocada la hoja en el marco

MECANIZADO DE TAPETA LATERAL

El mecanizado de la Tapeta 16.343 se realiza con el troquel 04.TRO.E150

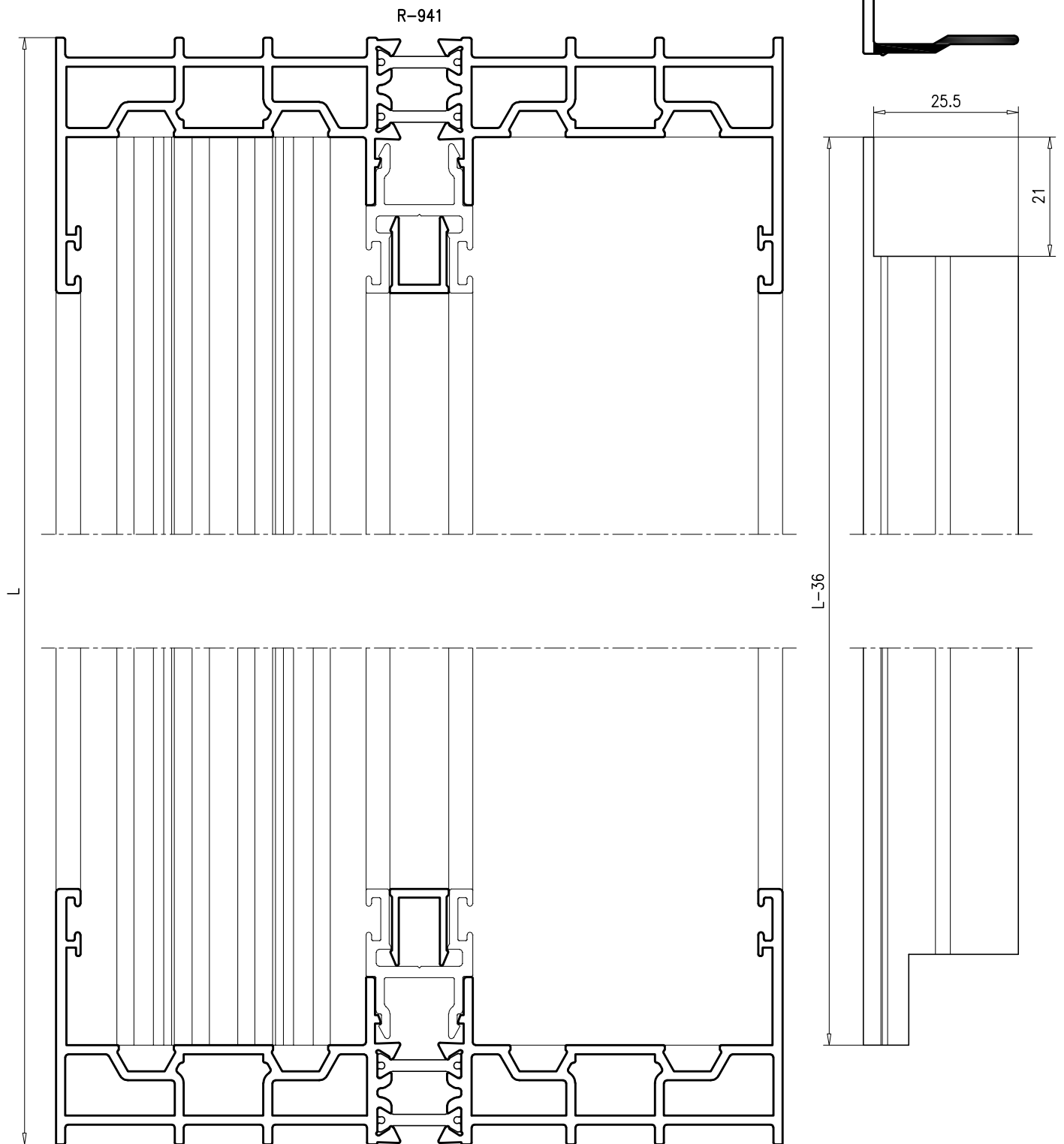

COLOCACION CALZOS HOJA FIJA

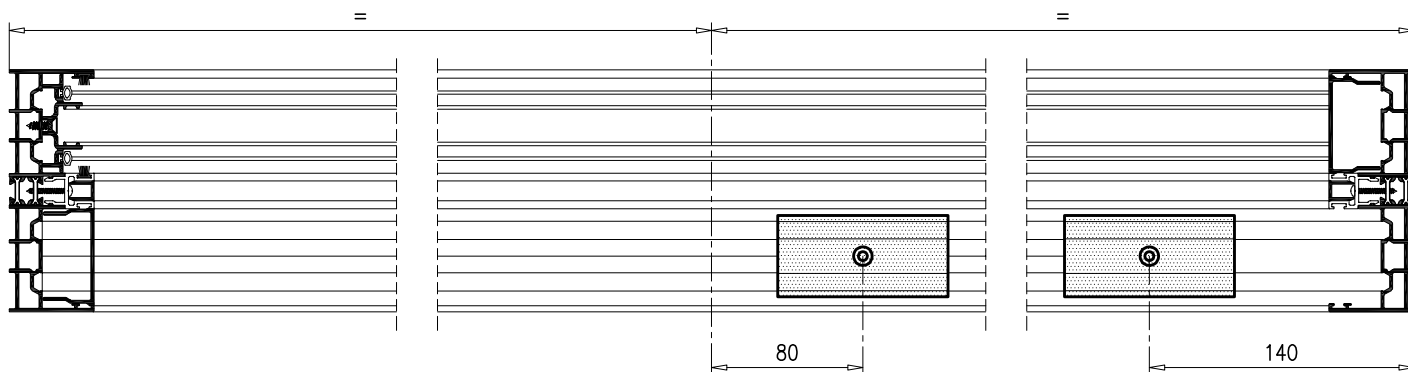
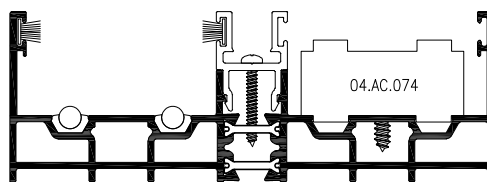
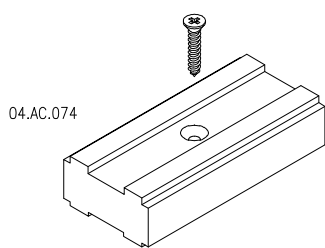

MECANIZADO DE TAPETA SUPERIOR E INFERIOR PARA HOJA FIJA

El mecanizado de la Tapeta 16.343 se realiza con el troquel 04.TRO.E150

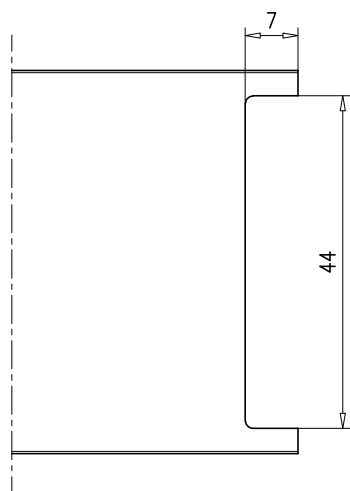
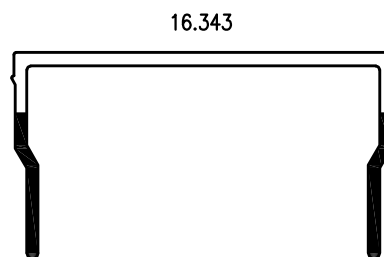
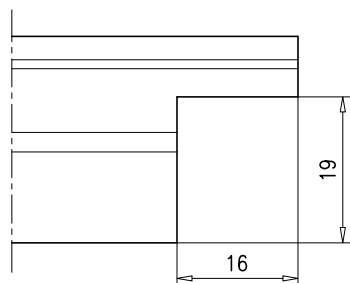

COLOCACION TACO ESTANQUEIDAD LATERAL INFERIOR Marco Inferior Oculto con Tapas de Aluminio o Piso Corrido

El Perfil de Cierre 16.341 con las juntas 04.JU.004.D se fija a los Marcos Laterales antes de ensamblar el Marco
 Los Tacos 04.AC.075 ó 04.AC.081 tienen una cara adhesiva y se colocan y fijan en el Marco Lateral una vez ensamblado

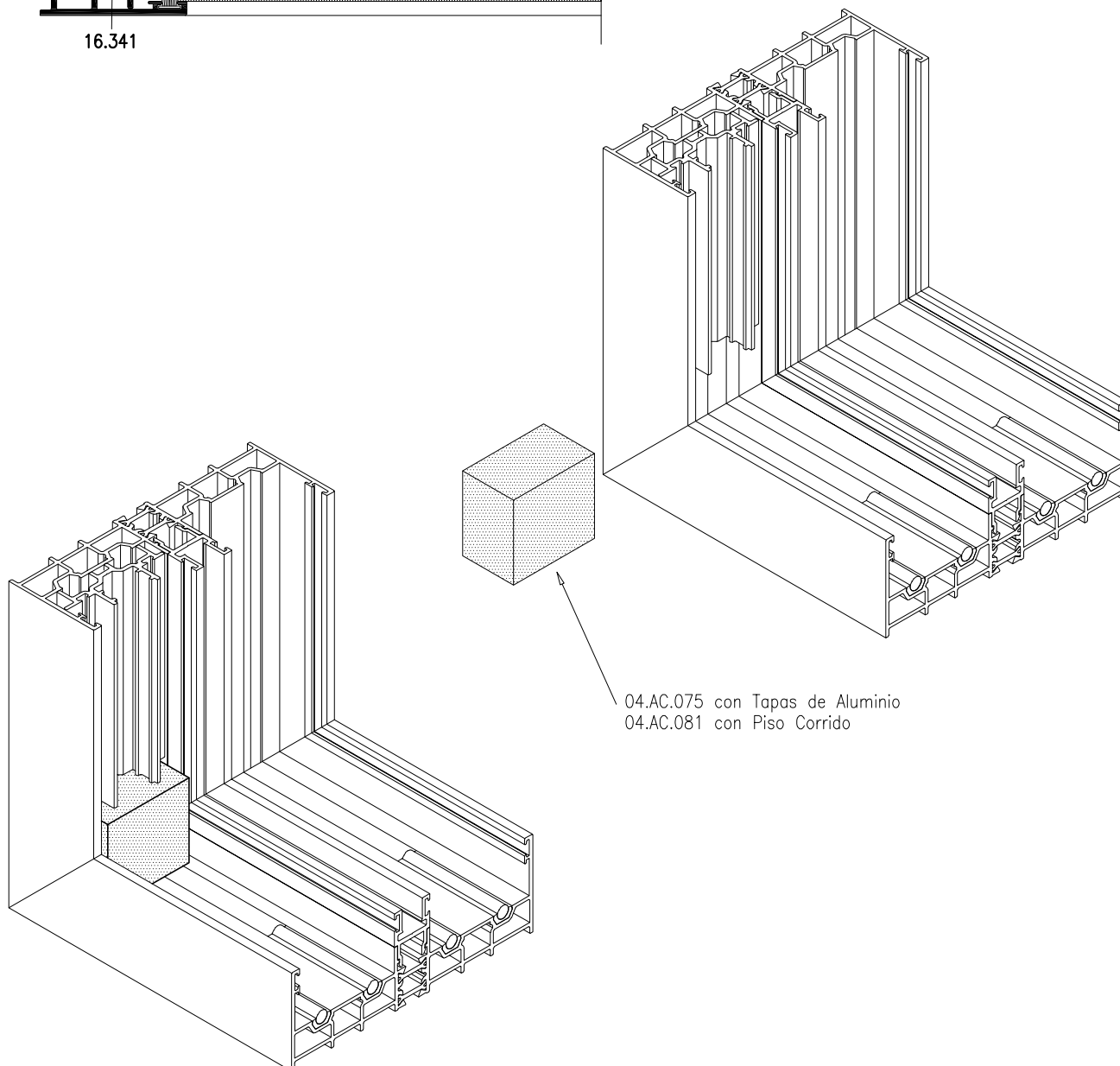
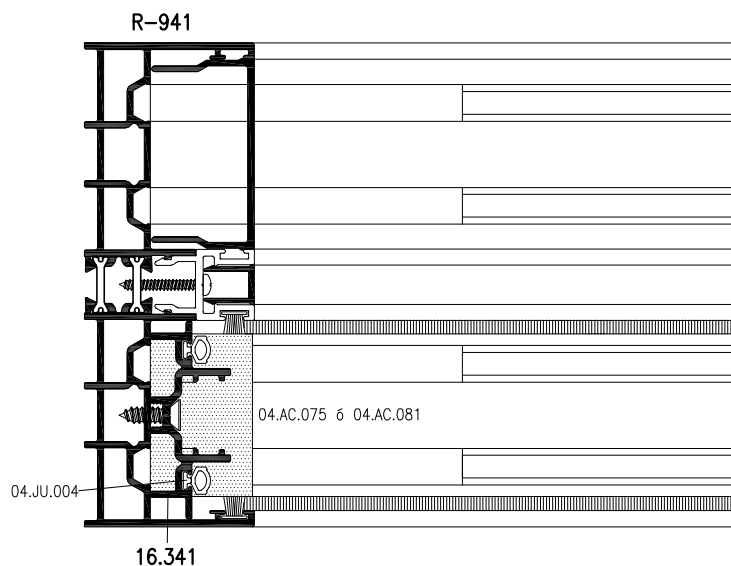

MECANIZADO DEL PARTELUCES DE CIERRE DE ENTREMUROS

El mecanizado del perfil 16.350 se realiza con el juego de fresas 04.TRO.JF150

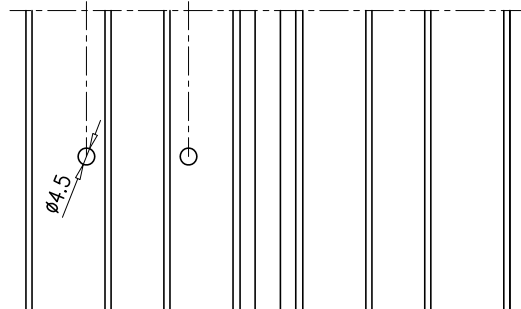
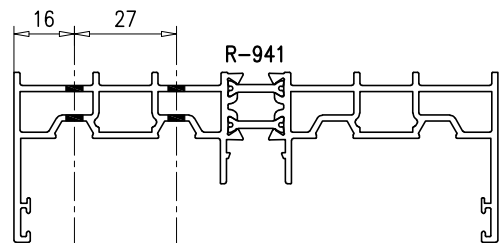
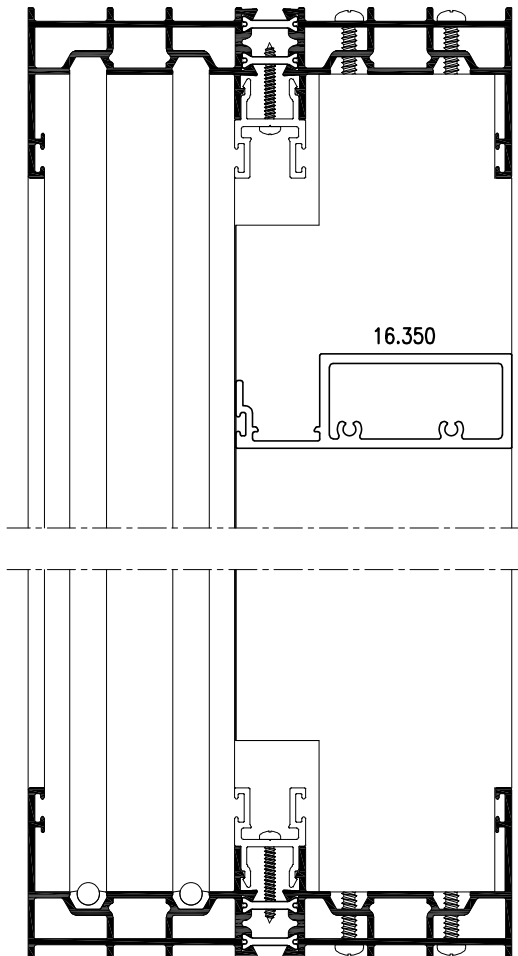
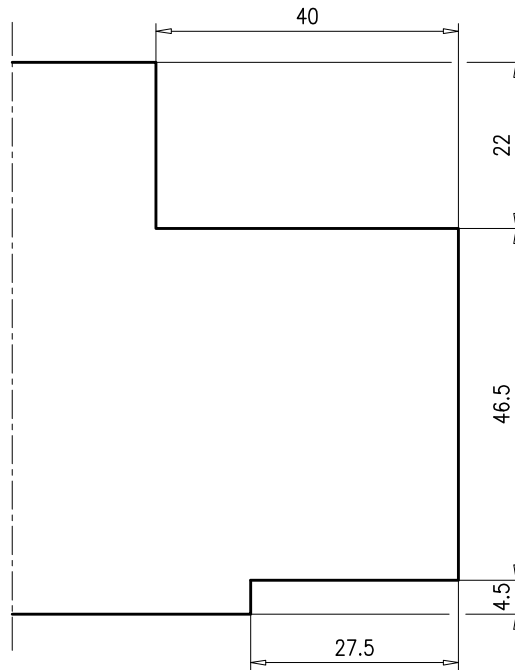
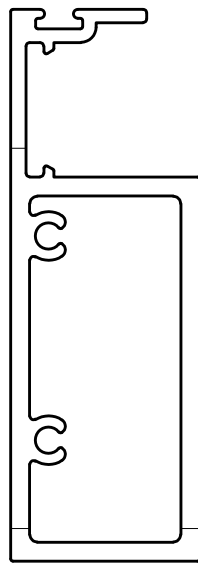

El troquel 04.TRO.E150 contiene una plantilla para posicionar los taladros en el marco

MECANIZADO PARA LA UNION DE MARCOS A 90° CON CORTE EN RECTO con Tocho 04.TO.025

El mecanizado del Marco R-941, R-943 y R-952 se realiza con el troquel 04.TRO.E150

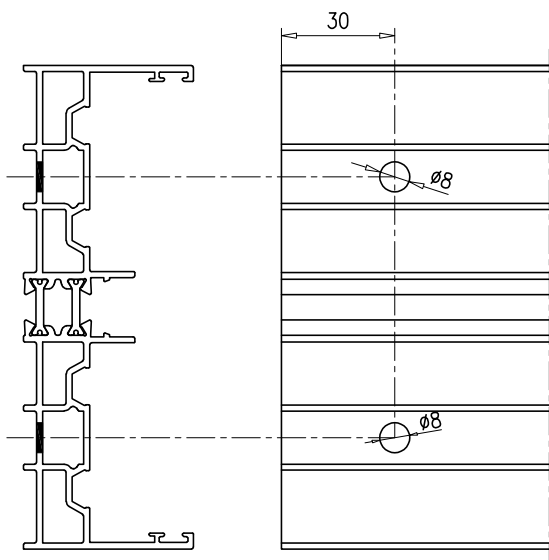

MECANIZADO MARCO SUPERIOR/INFERIOR

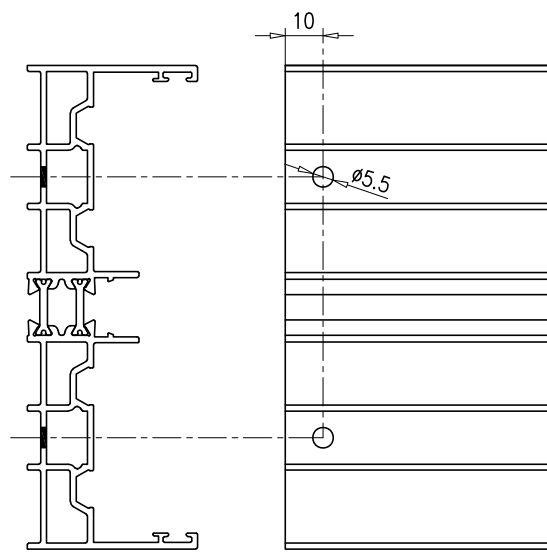

MECANIZADO MARCOS LATERALES

Es necesario rebajar las aletas 45mm en los extremos de la Solera para el correcto asiento del Marco sobre ella

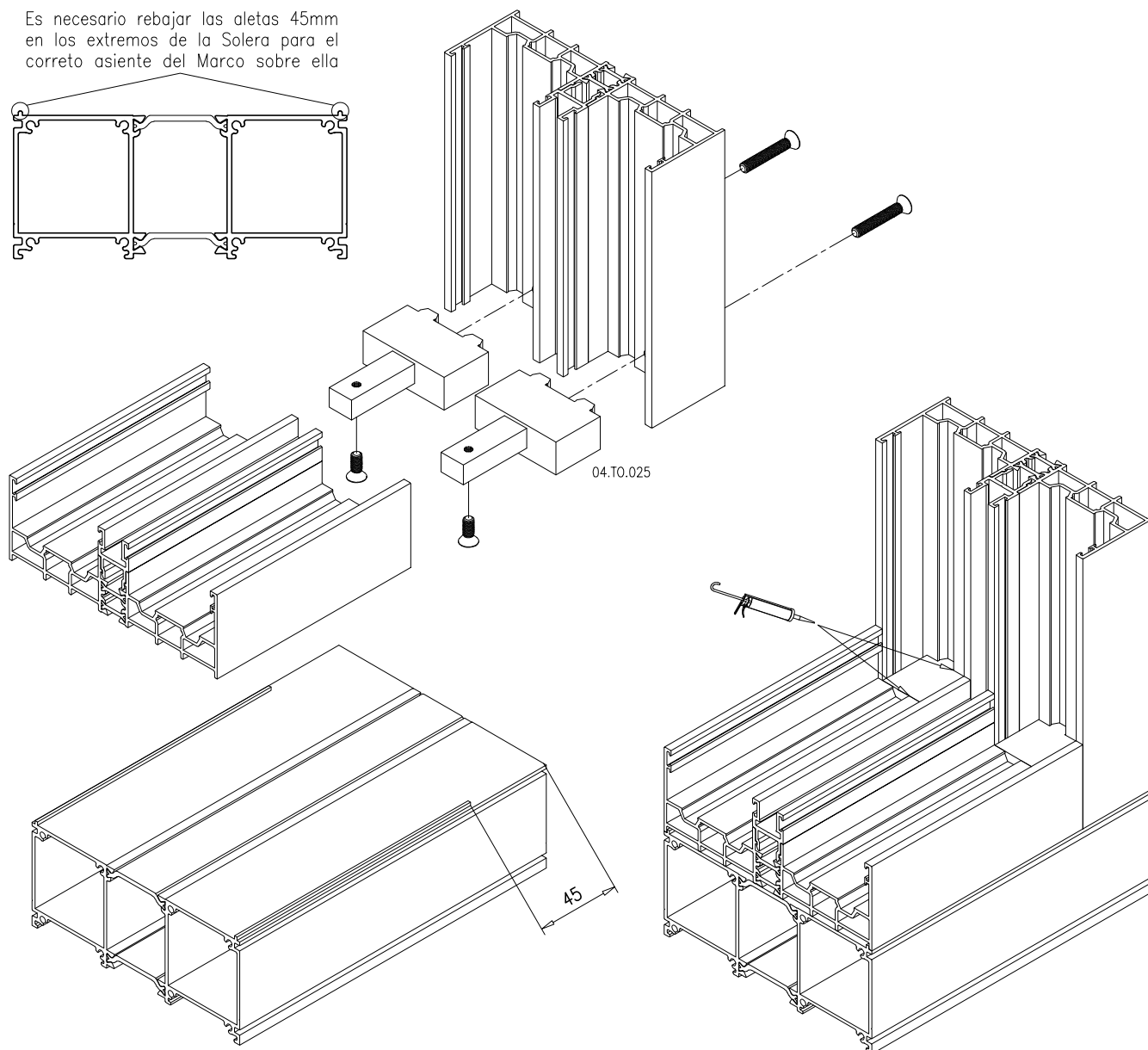
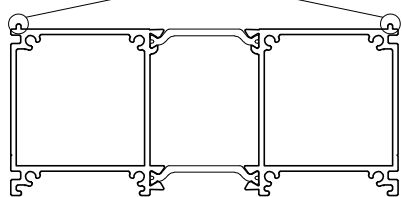

MECANIZADO PARA LA UNION DE MARCOS 04.TO.024

El mecanizado del Marco R-941, R-943 y R-952 se realiza con el troquel 04.TRO.E150

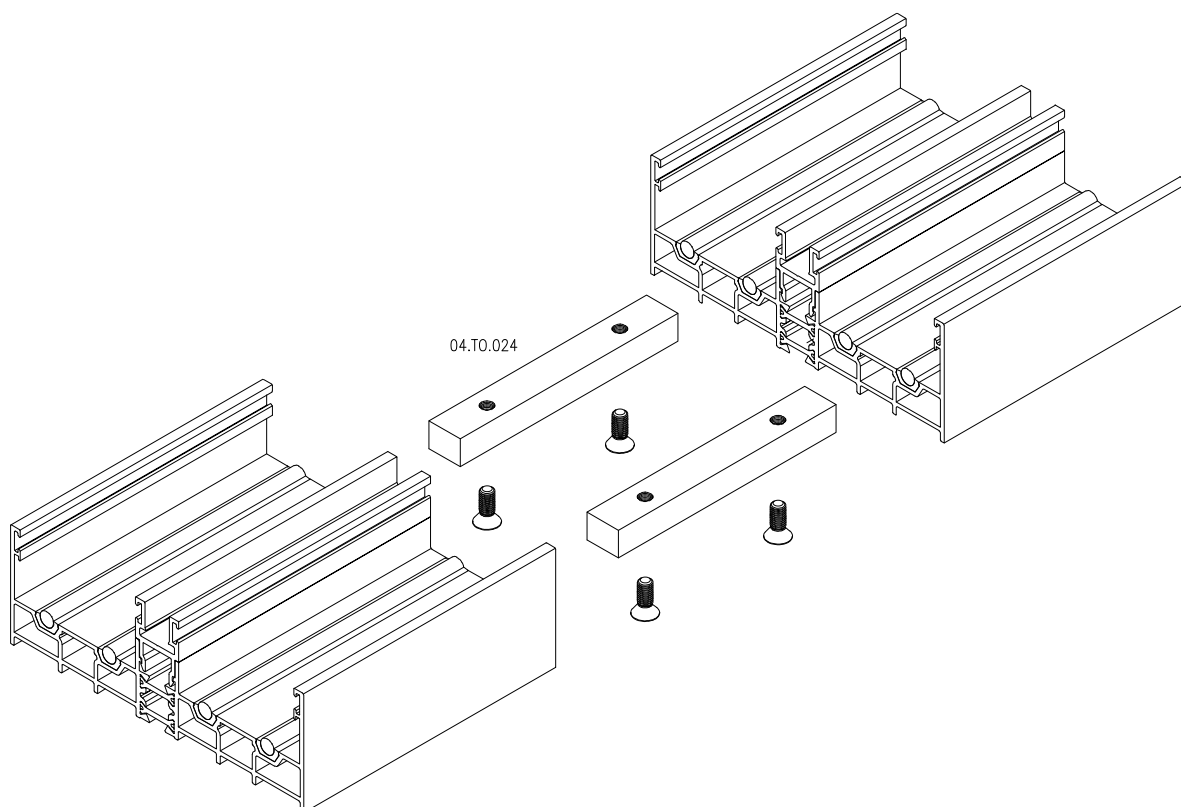
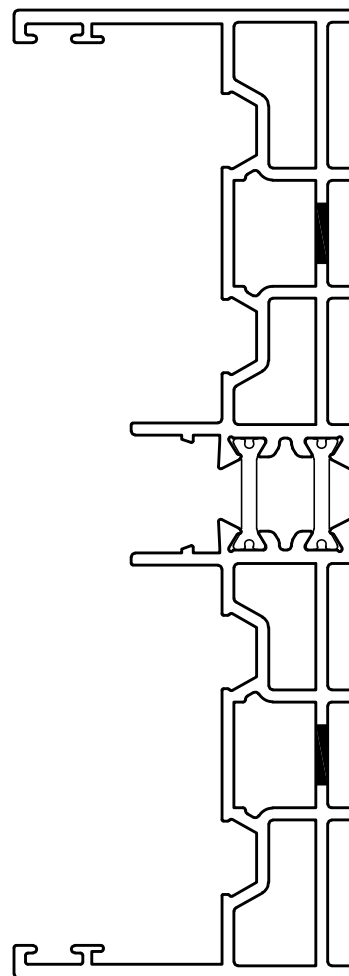
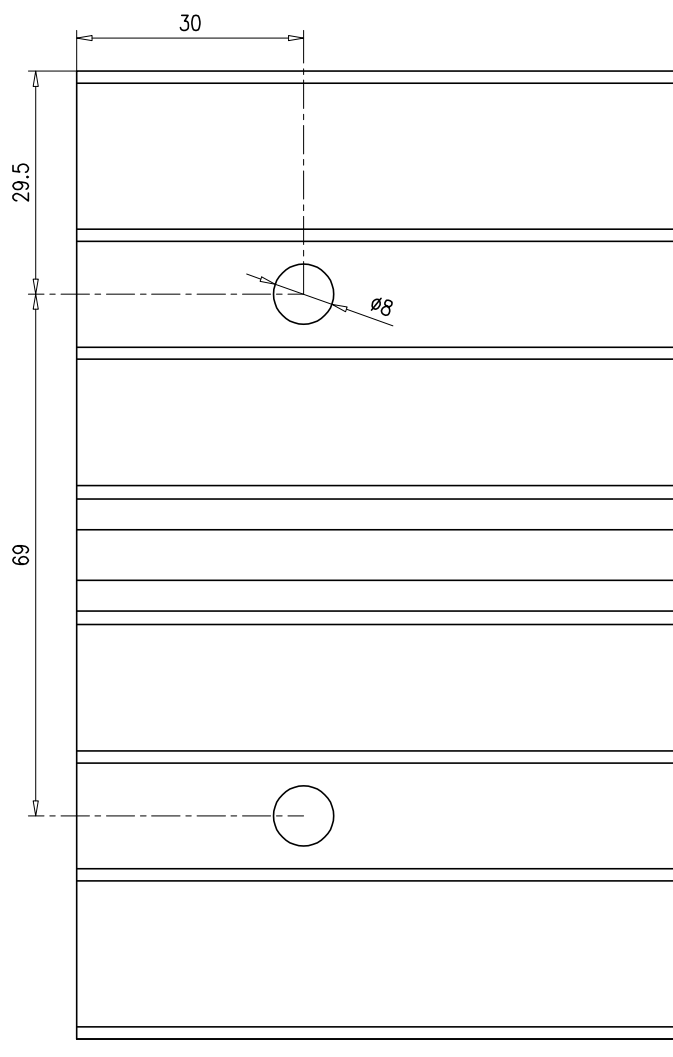

MONTAJE DEL TOPE DE HOJA 04.EL.017

El Tope de Hoja 04.EL.017 se coloca en el Marco Superior

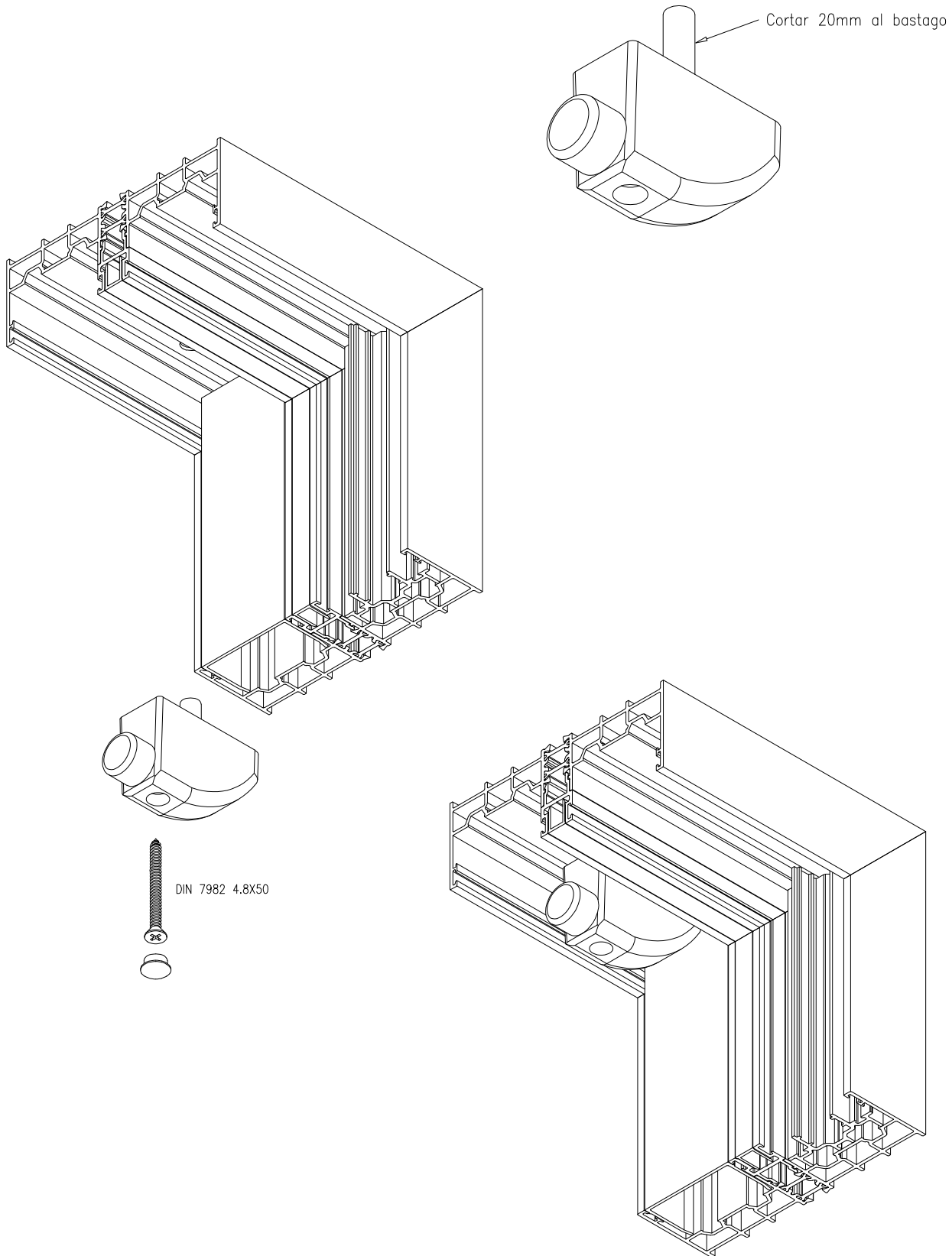

Tapa desagüe con deflector

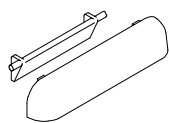

04.TA.016

Válvula desagüe Marco

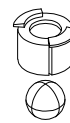

04.AC.001

MECANIZADO DE DESAGÜES EN MARCOS INFERIORES

Los mecanizados tipo "A" se realizan con el troquel 04.TRO.E150, distancia máxima entre estos 500mm

Los mecanizados tipo "B" se realizan con el troquel 04.TRO.E150

Los mecanizados tipo "C" se realizan con una broca \varnothing 12mm

Los mecanizados tipo "D" se realizan con una broca \varnothing 4mm

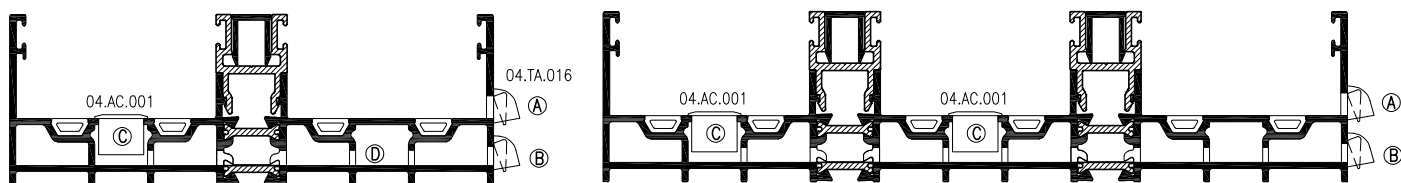

DESAGÜE OCULTO

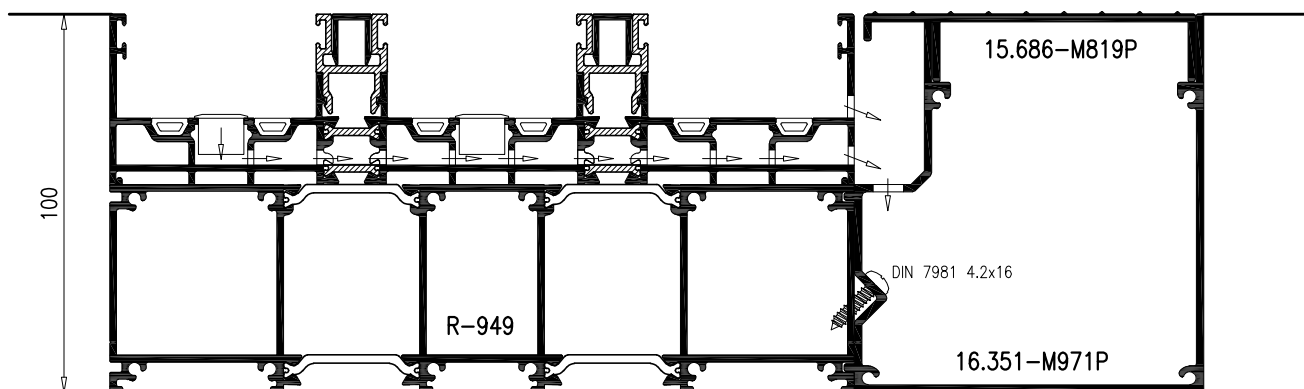
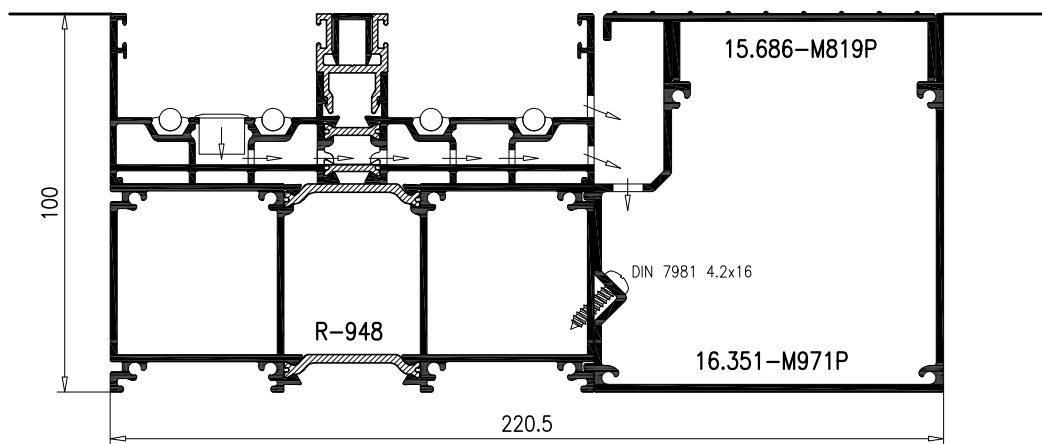

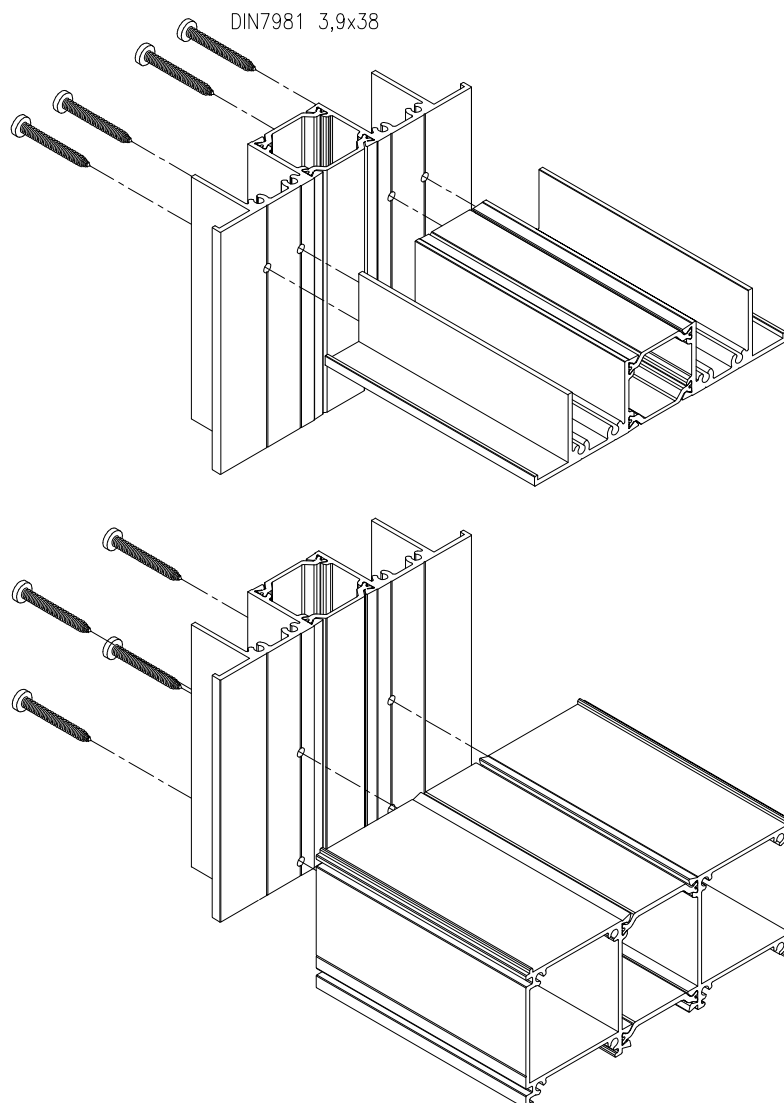
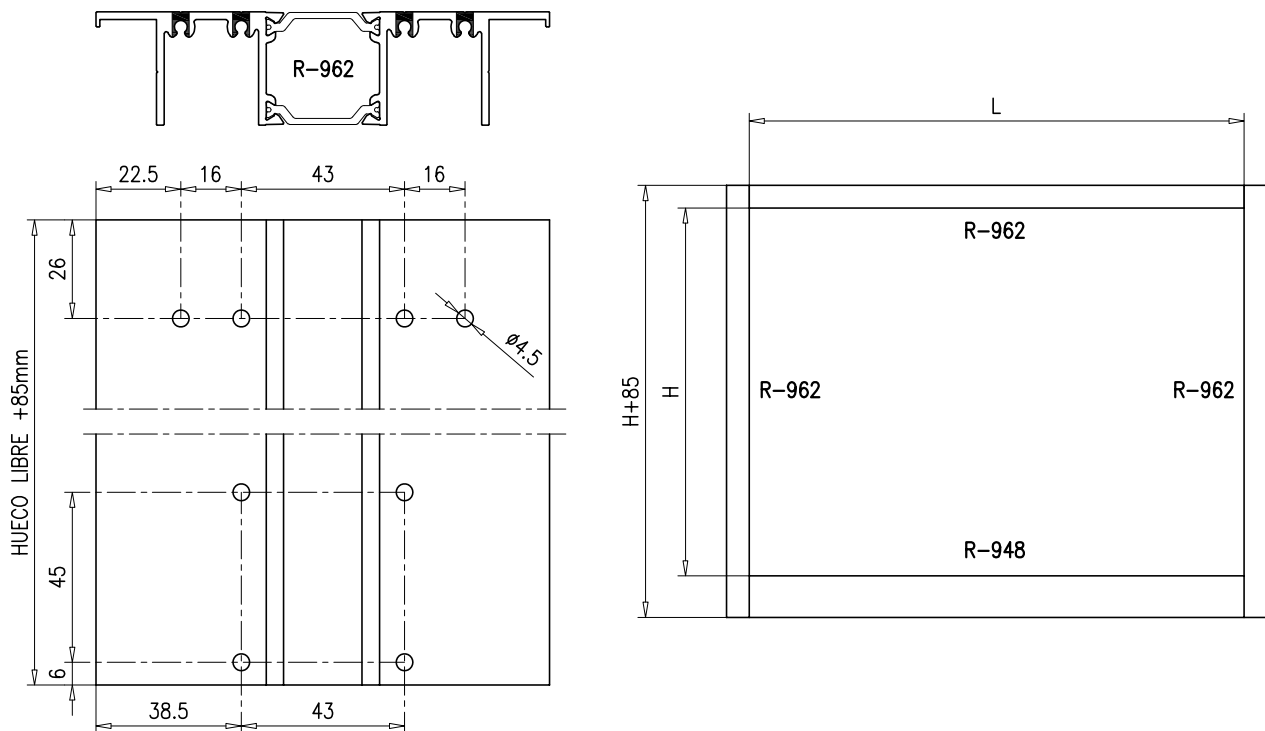
Mecanizado Premarco de Obra R-962 para Marco de 2 Carriles

Mecanizado Premarco de Obra R-963 para Marco de 3 Carriles

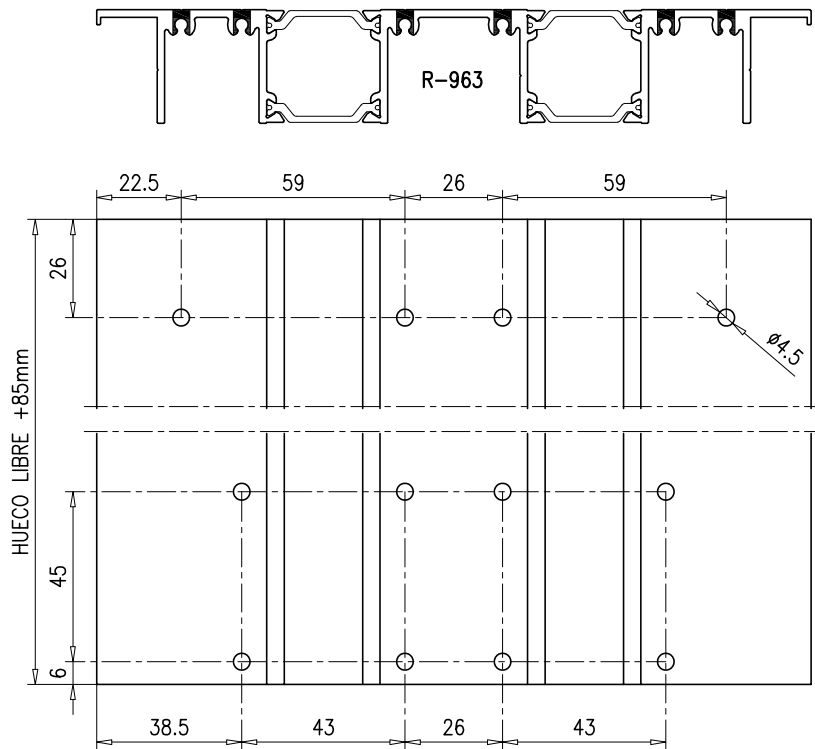

Mecanizado Premarco de Obra R-964 para Marco de 4 Carriles

